

## Side view

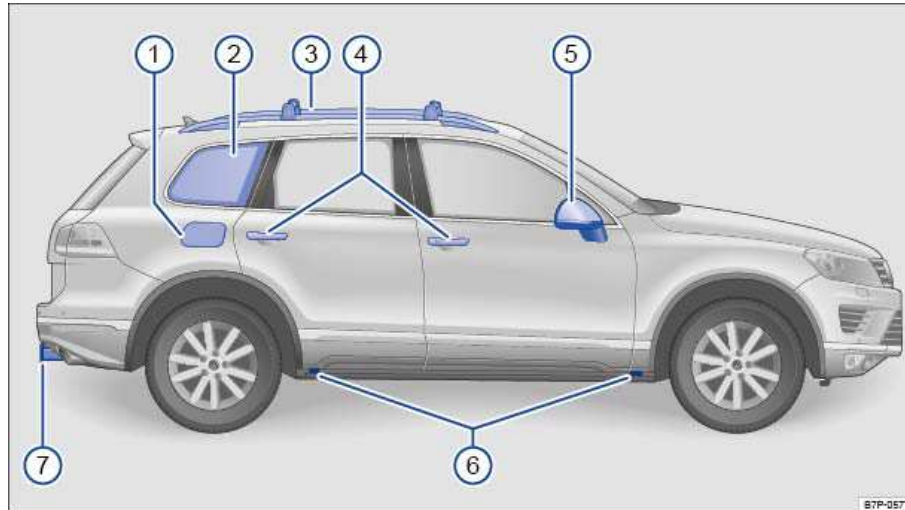

**Fig. 1** Vehicle side overview.

Key to **fig. 1**:

- (1) Fuel filler flap
- (2) Side window with window diversity antenna for:
  - Radio
  - Central locking
- (3) Roof rack
- (4) Outside door handles
- (5) Outside mirror:
  - Additional turn signal light
  - Area view
- (6) Lift points for the jack
- (7) Trailer hitch/ball mount receiver

## Front view

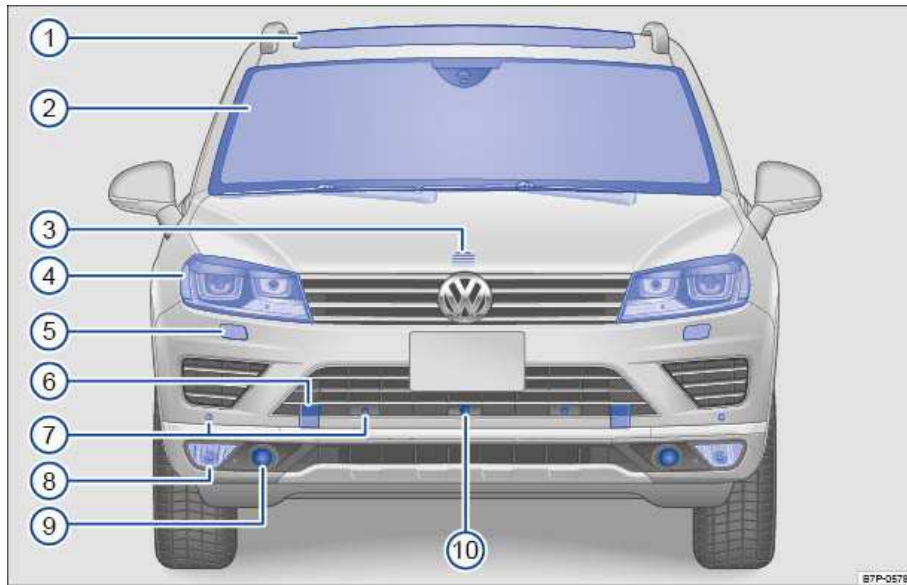
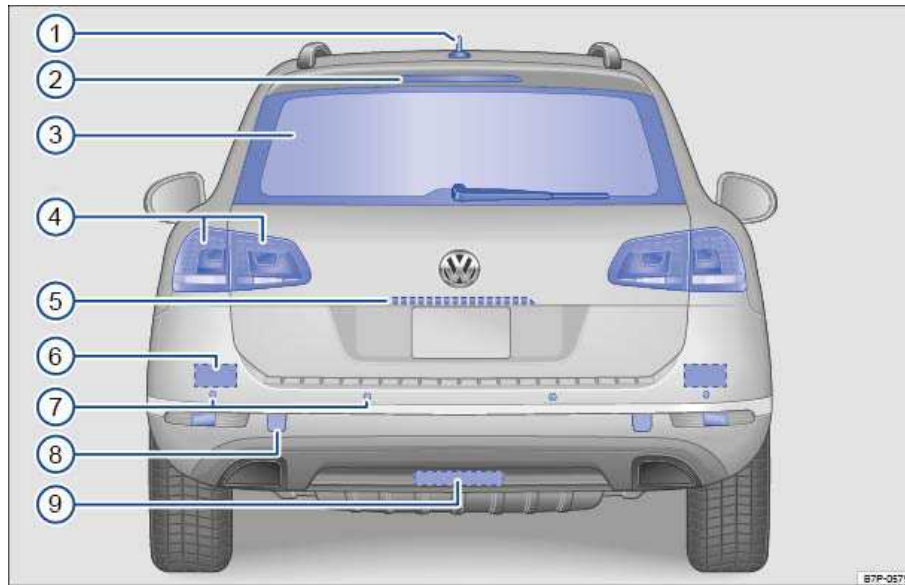

Fig. 2 Vehicle front overview.

Key to fig. 2:

- (1) Power sunroof
- (2) Windshield area with:
  - Rain sensor on mirror base
  - Low-light sensor on mirror base
  - Dynamic high beam control on mirror base
  - Windshield wipers
- (3) Engine hood release
- (4) Headlights (on both left and right) ,
- (5) Headlight washers (on left and right)
- (6) Threaded hole for the front towing eye (on both left and right) behind covers
- (7) Sensors for front Park Distance Control (on both left and right)
- (8) Fog lights/static cornering lights (on both left and right)
- (9) Radar sensors for the adaptive cruise control (ACC) (on both left and right)
- (10) Camera for Area View

## Rear view



**Fig. 3** Vehicle rear overview.

Key to **fig. 3**:

- (1) Roof antenna for:
  - Mobile phone
  - Navigation
- (2) High-mounted brake light
- (3) Rear window with:
  - Rear window defroster
  - Rear window wiper
- (4) Taillights (on both left and right)
- (5) Area of:
  - Button to open the rear hatch
  - Rear Assist camera and the Area View camera
  - License plate lighting
- (6) Radar sensors for Side Assist
- (7) Sensors for rear Park Distance Control
- (8) Threaded hole for the rear towing eye (on both left and right) behind covers
- (9) Trailer hitch/ball mount receiver

## Driver door overview

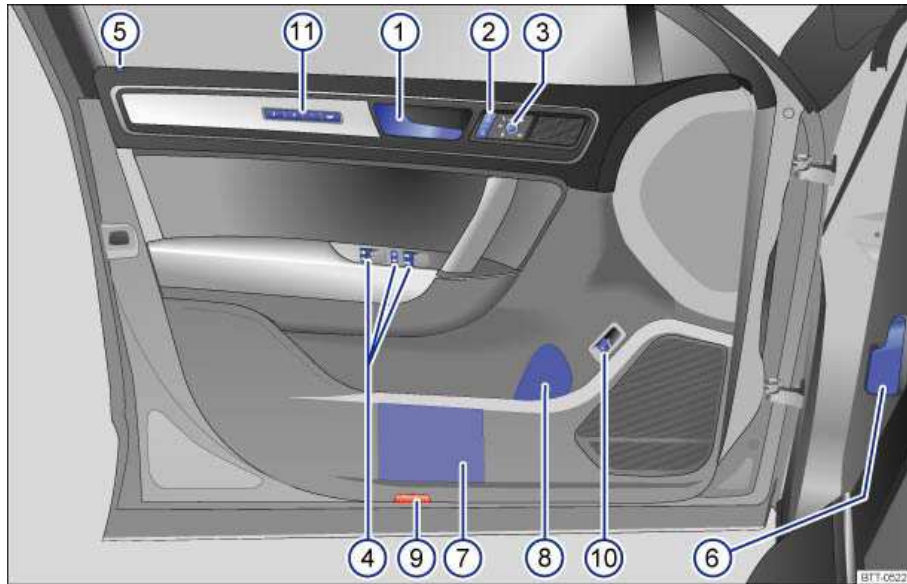







Fig. 4 Overview of controls in the driver door.

Key to fig. 4:

- (1) Door handle
- (2) Power locking switch for locking and unlocking the vehicle 
- (3) Switch for adjusting the outside mirror:
  - Adjusting outside mirrors L - 0 - R
  - Outside mirror heating 
  - Folding mirror 
- (4) Buttons for operating the power windows:
  - Power windows 
  - Safety switch for rear power windows and electric child safety lock 
- (5) Indicator for power locking system
- (6) Lever for releasing the engine hood
- (7) Storage compartment
- (8) Bottle holder
- (9) Door light
- (10) Switch to unlock the rear hatch 
- (11) Memory buttons for storing the driver seat and outside mirror settings **3 - 2 - 1 - SET**

## Driver side overview

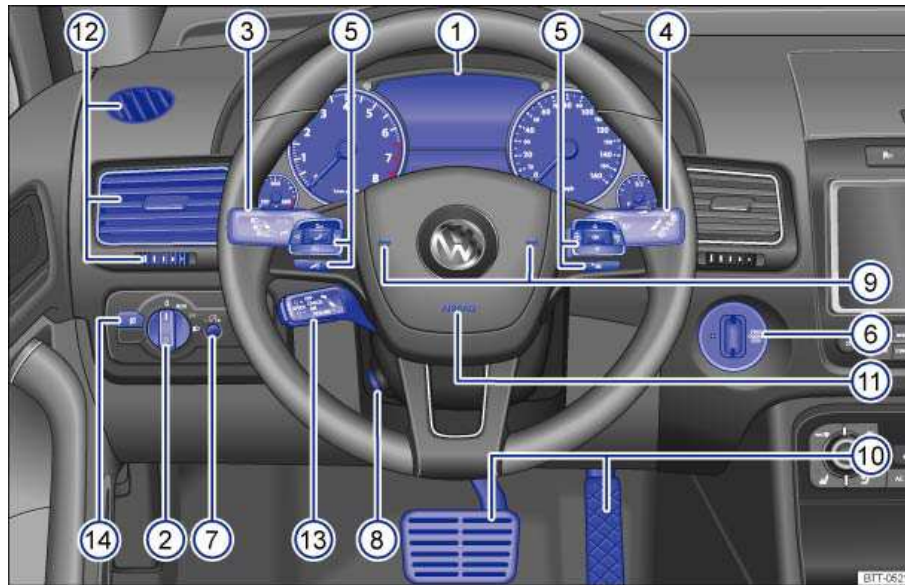



























Fig. 5 Driver side overview.

Key to fig. 5:

- (1) Instrument cluster:
  - Instruments
  - Display
  - Warning and indicator lights
- (2) Headlight switch 
  - Off position -0-
  - Automatic headlight activation -**AUTO**-
  - Parking lights and low beams  
- (3) Lever for:
  - High beams 
  - Headlight flasher 
  - Turn signals 
- (4) Lever for windshield wiper and washer:
  - Windshield wiper **HIGH – LOW**
  - Intermittent operation for windshield wipers 
  - “One-tap wiping” 
  - Windshield wiper 
  - Automatic wipe/wash for windshield 
  - Rear window wiper 
  - Automatic wipe/wash for rear window 
  - Lever with buttons for the Volkswagen Information System (Basic version) **TRIP-**, **OK/RESET**
- (5) Multi-function steering wheel controls:
  - Volume setting for radio, navigation system notifications, or telephone calls (if applicable) 

- Mute switching for radio or activation of voice control (if applicable) 
  - Display Phone main menu or accept telephone calls 
  - Audio, Navigation 
  - Control switches for the Volkswagen Information System (Premium version)       
 
- (6) Ignition switch
  - (7) Dimmer control for the Instrument cluster and switch illumination 
  - (8) Switch for adjusting the electric steering column
  - (9) Horn (only works when the ignition is switched on)
  - (10) Pedals
  - (11) Driver front airbag
  - (12) Air vents 
  - (13) Cruise Control System (CCS) lever **OFF – CANCEL – ON – RESUME – SPEED – SET**
  - (14) Fog light button 

## Upper center console

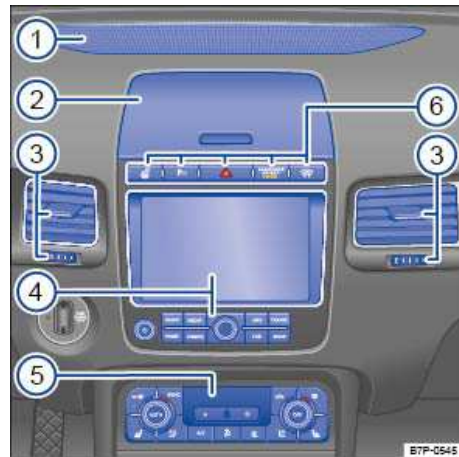









Fig. 7 Overview of upper center console.

Key to fig. 7:

- (1) Air vent for indirect ventilation
- (3) Air vents . . . .
- (2) Storage compartment
- (4) Radio or Radio & Navigation system (factory installed)
- (5) Controls for:
  - Climatronic
  - Seat heating switch button 
- (6) Located here:
  - Switch for emergency flashers 
  - PASSENGER AIR BAG OFF ; light (front airbag for front seat passenger)
  - Park Distance Control system button  or 
  - Rear View camera 
  - Heated steering wheel 

## Lower center console

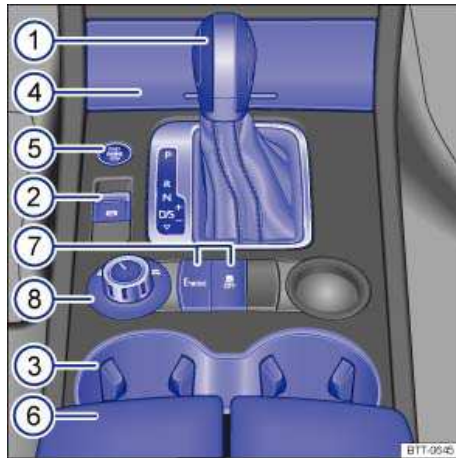



Fig. 8 Overview of lower center console (4MOTION).

Key to fig. 8:

- (1) Automatic transmission selector lever
- (2) Button for:
  - Electronic parking brake 
- (3) Cup holders
- (4) Storage compartment
  - with 12 Volt socket
- (5) Starter button for Keyless Access locking and starting system **START – STOP**
- (6) Storage compartment in the center armrest
- (7) Button for:
  - Driving with electric motor **E-MODE**
  - Anti-slip regulation (ASR) 
- (8) Rotary knob for setting drive mode (On-road / Off-road)



## Rear center console

---

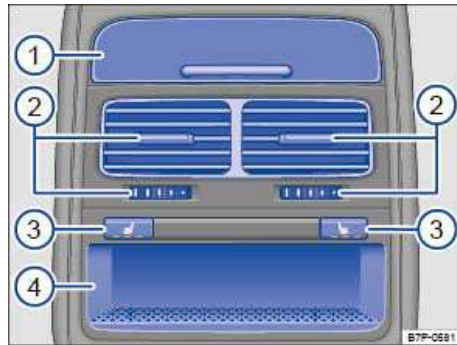

**Fig. 10** Overview of rear center console.

Key to **fig. 10**:

- (1) Cover for:
  - 12 Volt socket
  - 115 Volt outlet
- (2) Air vents . . .
- (3) Controls for:
  - Seat heating button 
- (4) Storage compartment in the rear center console

## Front passenger side overview

---

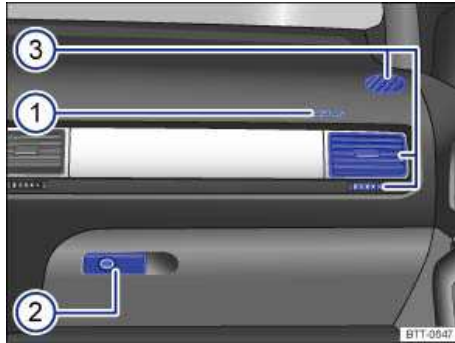

**Fig. 11** Overview of the passenger side.

Key to **fig. 11**:

- (1) Passenger front airbag location in the instrument panel (approximate)
- (2) Opening handle for the lockable glove compartment
- (3) Air vents . . .

## Roof console overview

---

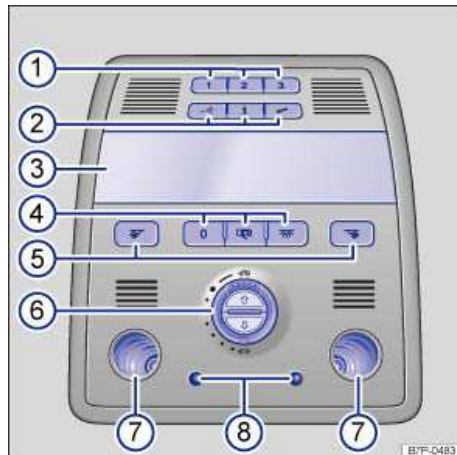









Fig. 12 Overview of the roof console.

Key to fig. 12:

- (1) Buttons for HomeLink® Universal Transmitter 1 2 3
- (2) 3 button module
  - Voice operation 
  - Information 
  - Assistance 
- (3) Interior and reading lights .
- (4) Buttons for interior lights
  - Button for Interior lights 
  - Switch for door contact 
  - Switch off interior lights 
- (5) Button for reading lights 
- (6) Switch for power sunroof
- (7) Reading lights
- (8) Background lighting

# Instrument Cluster

## Introduction

In this section you'll find information about:

Instrument overview

Instrument overview

Displays

Compass

Service reminder display

### More information:

- Service reminder information ⇒ Booklet *Warranty and Maintenance*.
- Warning and indicator lights
- Infotainment System
- Display of the selected gears (automatic transmission)

**⚠ WARNING**

**Driving on today's roads demands the full attention of the driver at all times. Driver distraction causes accidents, collisions and serious personal injury!**

- **Never use the buttons in the instrument cluster while driving.**

## Instrument overview

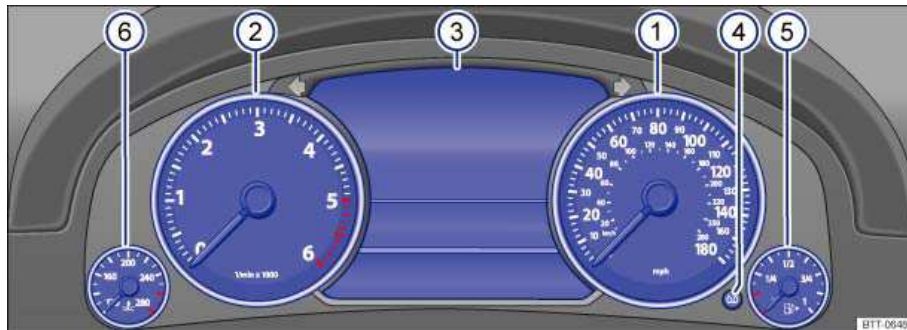



Fig. 13 Instrument cluster in the instrument panel.

**⚠ Please first read and note the introductory information and heed the WARNINGS**



Instrument explanations to fig. 13:

- (1) **Speedometer**
- (2) **Tachometer** (shows engine revolutions per minute in thousands, when the engine is running).

The red zone at the end of the scale indicates maximum permissible engine rpm (revolutions per minute) for all gears after the break-in period. Before reaching this region, select the next higher selector level position (D), or ease your foot off the accelerator ⇒ .

(3) **Displays**

(4) **Reset button** for the trip odometer display (**trip**) and **button** to display the engine code.

- Push and hold the  button about 1 second in order to reset to zero.
- Keep the  button pushed for about 3 seconds to display the previous value.
- Push and hold the  button for more than 10 seconds to display the vehicle's engine code. You must do this when the ignition is on, but the engine is not running.

(5) **Fuel gauge**

(6) **Engine coolant temperature display**

 **NOTICE**

- To help prevent engine damage, always avoid high engine speeds, full throttle acceleration and heavy engine loads when the engine is cold.
- To help prevent engine damage, the tachometer needle should only enter the red zone (warning zone) briefly.



Up-shifting early into the next higher gear saves fuel and reduces engine noise.

## Displays

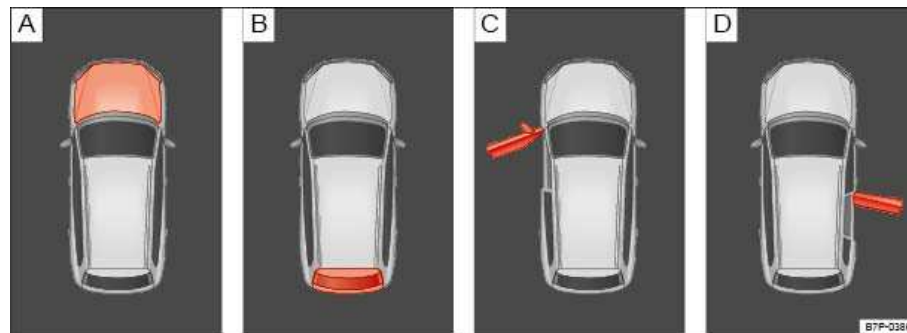

**Fig. 15** In the instrument cluster display: A: Open engine hood, B: Open rear hatch, C: Open front driver side door, D: Open rear passenger side door.

 **Please first read and note the introductory information and heed the WARNINGS **



Depending on the vehicle model, different information may be shown in the instrument cluster display ⇒ [fig. 13 \(4\)](#) ⇒ [fig. 14 \(4\)](#).

- Warning and information texts.
- Odometer displays.
- Time
- Navigation information
- Outside temperature.
- Compass display

- Open door, engine hood, or rear hatch ⇒ [fig. 15](#).
- Hybrid drive information
- AdBlue information
- Selector lever position
- Multi-Function Indicator (MFI) and menus for different settings
- Service reminder display
- Speed warning

#### Warning and information texts

The status of various vehicle functions and components is monitored when the ignition is switched on and while driving. Malfunctions are indicated by red and yellow warning symbols with text messages in the instrument cluster display (⇒ *Instrument cluster and instrument panel*). In some cases, they may also be signaled acoustically. The display can vary depending on the instrument cluster model.

Type of notification	Symbol color	Explanation
Priority 1 warning message	Red	<p>Symbol flashing or lit – sometimes with acoustic warnings.</p> <p> <b>Stop!</b> ⇒ </p> <p>Check malfunction and take corrective action. Contact an authorized Volkswagen dealer or an authorized Volkswagen Service Facility for assistance if necessary.</p> <p>Menus cannot be accessed when a priority 1 warning message is displayed. The warning message will turn off automatically after a few seconds. You can confirm and turn off some warning messages using the <b>OK</b> button.</p>
Priority 2 warning message	Yellow	<p>Symbol flashing or continuously lit – sometimes with acoustic warnings.</p> <p>Malfunctions or low operating fluid levels may cause vehicle damage and vehicle breakdown ⇒ .</p> <p>Check malfunction as soon as possible. Contact an authorized Volkswagen dealer or an authorized Volkswagen Service Facility for assistance if necessary.</p>
Information text	–	Information about various vehicle situations.

### Odometer displays

The *odometer* indicates the total distance driven by the vehicle.

The *trip odometer (trip)* shows the distance driven since the last time the trip odometer was reset. The last digit indicates 1/10 mile (100 meters).

### Outside temperature display

At outside temperatures below about +39 °F (+4 °C), a “snowflake symbol” (icy road warning) appears in the display. The symbol flashes at first, then stays on until the outside temperature rises above

+43 °F (+6 °C) ⇒ .

When the vehicle is not moving or when you are driving at very low speeds, the temperature displayed may be slightly higher than the actual outside temperature.

The measurement range is from -40 °F (-40 °C) to +122 °F (+50 °C).

### Compass display

When the ignition and navigation system are switched on, the current compass direction is indicated in the instrument cluster display ⇒ *Compass*.



### Selector lever positions

The selector lever position is shown both on the side of the selector lever and in the instrument cluster display. The respective gear may also be shown in the instrument cluster display in Drive (**D**) and Sport Drive (**S**), as well as in Tiptronic® mode.

### Speed warning

If you exceed the top speed that has been set, this will be signaled in the instrument cluster display. This feature is useful in various situations, for instance when using winter tires that are not designed for the vehicle's top speed.

The speed warning can be set and switched on and off in the Infotainment System.

- Switch on the ignition.
- Press the **CAR** Infotainment button.
- Tap the **Settings** function key on the screen.
- Select **Speed warning** from the list.
- Place your finger on the touchscreen slider  and, *keeping your finger on the screen*, move your finger to slide it to the desired speed setting.
- **OR:** Tap the  or  function key on the screen to move the slider in steps.
- Tap the **Active** function key on the screen to switch on the speed warning.

If the check box in the **Active** function key is checked , the feature is switched on.

### **WARNING**

**Failure to heed warning lights and instrument cluster text messages can cause the vehicle to break down in traffic and result in a collision and serious personal injury.**

- **Never ignore warning lights or text WARNINGS.**
- **Always stop the vehicle as soon as it is safe to do so.**
- **Park the vehicle at a safe distance from moving traffic and where no part of the hot catalytic converter and exhaust system can come into contact with flammable materials under the vehicle, such as dry grass, brush, spilled fuel, etc.**
- **A broken down vehicle presents a high accident risk for itself and others. Switch on emergency flashers and set up a warning triangle to warn oncoming traffic.**

## **⚠ WARNING**

Roads and bridges may be dangerously icy even if the outside air temperature is above freezing.

- If you use the outside temperature display to tell you about frost conditions, remember that roads can even ice over at temperatures above +39 °F (+4 °C). Always remember: even if the “snowflake symbol” (ice warning) is not displayed, there could still be black ice on the road.
- Never rely exclusively on the outside temperature display.

## **ⓘ NOTICE**

Failure to heed warning lights or text WARNINGS can result in vehicle damage.

**ⓘ** The instrument cluster displays and their arrangement may vary depending on the vehicle model and engine version. For displays without warning and information messages, malfunctions are only signaled with indicator lights.

**ⓘ** If there are multiple warning messages, the symbols are displayed for several seconds in order of importance. The symbols are displayed until the cause has been corrected.

## Compass

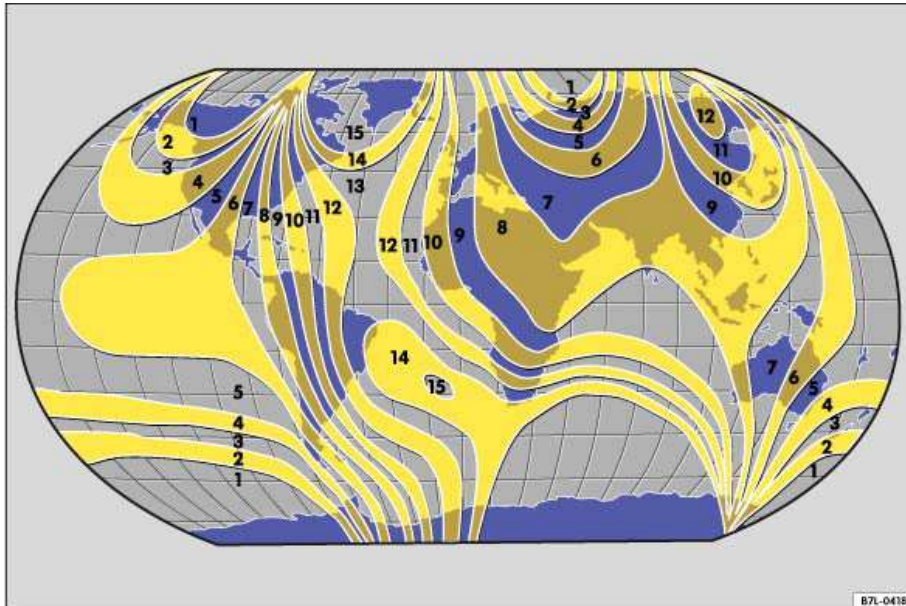

Fig. 16 Compass zones.



**ⓘ Please first read and note the introductory information and heed the WARNINGS ⚠**

The compass does not need to be calibrated in vehicles with a factory-installed navigation system. There is no **Compass** menu item in this case.

On vehicles without a factory-installed navigation system, the compass is calibrated automatically. If electrical or metallic accessories are added to the vehicle, the compass must be recalibrated.

#### **Adjusting the compass zone**

- Switch on the ignition.
- Select the **Settings** menu followed by the **Compass** and **Zone** menu items.
- Select the compass zone according to the current location ⇒ [fig. 16](#).
- Adjust and confirm compass zone (**1-15**) by using the arrow buttons.

#### **Calibrating the compass**

In order to calibrate the compass, you need a valid compass zone for the location and enough room to drive in a circle.

- Switch on the ignition.
- Select the **Settings** menu followed by the **Compass** and **Calibrate** menu items.
- Confirm the **Please drive a full circle to calibrate** message by pressing the **OK** button on the multi-function steering wheel, and then drive in a complete circle at about 6 mph (10 km/h).

During calibration, **CAL** is shown in the instrument cluster display. The calibration is complete when the compass direction is displayed.

## **Service reminder display**

---

**ⓘ Please first read and note the introductory information and heed the WARNINGS ⚠**

The service appointment reminder is shown in the instrument cluster display ⇒ [fig. 13 \(3\)](#) ⇒ [fig. 14 \(3\)](#). For more information, please See ⇒ Booklet *Warranty and Maintenance*.

Information on maintenance intervals ⇒ Booklet *Warranty and Maintenance*.

For vehicles with **time- or distance- driven dependent service**, fixed service intervals are displayed.

#### **Service reminder**

If service is due in the near future, a **service reminder** is displayed when the ignition is switched on an **Service in --- mi or --- days (Service in --- km or --- days)** is shown on the instrument cluster display.

#### **Service event**



When **service is due**, an audible signal sounds when the ignition is switched on, and a flashing wrench symbol  is displayed for several seconds. For *vehicles with text messages*, **Service now** is indicated on the instrument cluster display.

#### **Viewing service messages**

Service messages can be viewed in the Infotainment System.

- Switch on the ignition.
- Press the **CAR** Infotainment button.
- Tap the **Service** function key on the screen.

A **minus sign** in front of the number of miles (kilometers) or days means that **service is overdue**. **Service since --- mi or --- days (Service since --- km or --- days)** is shown on the display ⇒ [fig. 316](#).

 The service reminder disappears after a few seconds when the engine is running or the  button on the multi-function steering wheel has been pushed.

# Volkswagen Information System

## Introduction

---

In this section you'll find information about:

Menu structure – overview

Using the instrument cluster menus

Main menu

Vehicle menu

When the ignition is switched on, you can display different types of information in the instrument cluster. The menu options vary depending on whether you have a Basic or Premium version Volkswagen Information System. With the Premium instrument cluster display can also be used to control certain vehicle features.

Buttons on the windshield wiper lever operate the menus for Basic instrument cluster. The Premium version has control buttons on in the right side of the multi-function steering wheel.

The number of menus in the instrument cluster display depends on the electronics and equipment on the vehicle.

An authorized Volkswagen dealer or an authorized Volkswagen Service Facility may be able to add or modify functions depending on your vehicle's equipment

Some menu items can only be accessed when the vehicle is not moving.

As long as a priority 1 warning message is displayed, no menus can be accessed on vehicles with the Premium instrument cluster. In order to display menus, acknowledge the warning by pressing the  button on the multi-function steering wheel.

### More information:

- Outside mirrors
- Infotainment System



### WARNING

**Driving on today's roads demands the full attention of the driver at all times. Driver distraction causes accidents, collisions and serious personal injury!**

- **Never access menus when the vehicle is moving.**



Emergency starting and starting the engine with a very weak vehicle battery or after the vehicle battery has been replaced may change or delete system settings (including time, date, personal convenience settings and programming). Check the settings and correct as necessary once the vehicle battery has built up a sufficient charge.

## Menu structure – overview

---

 Please first read and note the introductory information and heed the **WARNINGS** 

### Vehicle

- Vehicle status

- Hybrid
- Tire pressure
- Display since start
- Display since refuel
- Display long-term
- Digital speed (digital speed display).

#### Navigation

#### Audio

- Source list
  - DAB
  - FM
  - AM
  - Radio memory
  - HDD
  - SD
  - DVD
  - USB
  - Bluetooth
  - TV tuner
  - TV station memory
  - External AV source

#### Telephone

- Directory
- Dialed numbers
- Missed calls
- Received calls

## Using the instrument cluster menus

---



Fig. 17 Right side of the multi-function steering wheel: Controls for the menus in the instrument cluster.





**⚠ Please first read and note the introductory information and heed the WARNINGS ⚠**

#### Displaying the main menu

- Switch on the ignition.
- If a message or the vehicle pictograph is displayed, press the **OK** button ⇒ fig. 17.
- To scroll through the individual main menu items, push keys **◀** or **▶** several times



- To access a menu item, press the  button.

#### Displaying a sub-menu

- Press the  button on the multi-function steering wheel to access a submenu.
- Press the  or  buttons until the menu item you want is highlighted. The highlighted menu item is between the two horizontal lines.
- Highlight or confirm the selection with the  button.

If you make no selection within about 10 seconds, the screen switches back to the previous menu.

#### Returning to the main menu

- Press the  or  buttons ⇒ [fig. 17](#).

## Main menu

 Please first read and note the introductory information and heed the **WARNINGS** 

Menu	Function	See
<b>Navigation</b>	<p>Information displays from active navigation system:</p> <p>Turn arrows and proximity bars are shown if route guidance is activated. The design is similar to the symbols used in the Infotainment System.</p> <p>If route guidance is inactive, the display shows the direction of travel (compass direction) and the name of the road or street you are now on.</p>	
<b>Audio</b>	<p>Display of radio station you are listening to.</p> <p>Display of CD being played.</p> <p>Display of various media sources.</p>	
<b>Telephone</b>	<p>Display of the directory and various calling information.</p> <p>Use of telephone features.</p>	

Menu	Function	See
Vehicle	Display of current warnings or text messages and other system components depending on the equipment level.	
	Information and settings for the multi-function indicator (MFI).	

## Vehicle menu

 Please first read and note the introductory information and heed the WARNINGS

Menu	Function
Vehicle status	Display and storage of current warning and information messages. This menu item appears only if there are current warnings or text messages. The number of available messages is shown in the display. Example: 1/1 or 2/2.
Hybrid	Shows the current energy flow for hybrid vehicles
Tire pressure	Display of current tire pressures in vehicles with direct Tire Pressure Monitoring System (TPMS) ⇒ page 203.
Display since start	Trip memory: Display and storage of the driving and fuel consumption data compiled from the time the ignition is switched on to the time it is switched off. If the journey is continued within two hours after the ignition is switched off, the information from the new leg of the journey is counted as well. The memory is automatically cleared if the vehicle is not driven for more than two hours.
Display since refuel	Trip memory: Display and storage of driving and fuel consumption data. The memory is automatically cleared when the vehicle is fueled again.

<b>Menu</b>	<b>Function</b>
<b>Display long-term</b>	Trip memory: Display and storage of the accumulated driving and fuel consumption data of any number of single trips up to a total driving time of either 19 hours and 59 minutes or 99 hours and 59 minutes, and up to a total distance of either 1,999.9 miles (1,999.9 km) or 9,999 miles (9,999 km), depending on the instrument cluster version. If one of the stored values is exceeded, then the memory is automatically cleared and starts again from 0.
<b>Digital speed</b>	Switch the digital speed on or off. Shows the current vehicle speed in digital form.
<b>Alt. speed display</b>	Switch the second speed on or off. Shows the current vehicle speed in digital form.
<b>Back</b>	The display switches back to the main menu.



#### **Possible displays**

When selecting 1 of the 3 trip memories **Display since start**, **Display since refuel**, or **Display long-term**, you can access the following submenus:

<b>Submenu</b>	<b>Function</b>
<b>Travel time</b>	Driving time in hours (h) and minutes (min) corresponding to the trip memories <b>Display since start</b> , <b>Display since refuel</b> , or <b>Display long-term</b> (toggle).
<b>Current consumption</b>	Current fuel consumption in miles per gallon (l/100 km) while driving. When units are set to miles, dashes appear instead of a number when the engine is running and the vehicle is standing still. When units are set to kilometers, the display shows liters consumed per hour when the engine is running and the vehicle is standing still.

<b>Submenu</b>	<b>Function</b>
<b>Average consumption</b>	Average fuel consumption in miles per gallon (l/100 km) on trips per trip memories is displayed once the vehicle has been driven about 330 feet (100 m). Until then, dashes appear instead of a number. The value displayed is updated every 5 seconds.
<b>Range</b>	Estimated distance in miles (km) that the vehicle can go with the fuel left in the tank the way you are currently driving. Takes account of the current fuel consumption, among other things.
<b>Distance</b>	Distance driven in miles (km) from the time the ignition was switched on.
<b>Average speed</b>	The average speed is displayed after the ignition is switched on and the vehicle has been driven about 300 feet (100 m). Up to this point, dashes appear instead of a number. The value displayed is updated every 5 seconds.
<b>AdBlue</b>	This display appears when the AdBlue fuel range falls to about 1500 miles (2400 km) and then provides current information as the range continues to diminish. You must refuel with AdBlue within this range

#### **Switching between the displays**

- Press the  or  button on the multi-function steering wheel.

#### **Clearing a memory manually**

- Select the memory that you want to clear
- Press and hold the  button on the multi-function steering wheel for about 2 seconds.



## Driving checklists and warnings

### Introduction

---

In this section you'll find information about:

- Getting ready and driving safely
- Driving in other countries
- Driving through water on roads

Depending on where the vehicle is used, it might be advisable to install drivetrain underbody protection. Drivetrain underbody protection can reduce the risk of damage to the vehicle underbody and engine oil pan when driving over curbs, on rough private roads, or on dirt roads, for example. Volkswagen recommends having the work done by an authorized Volkswagen dealer or an authorized Volkswagen Service Facility.

#### **More information:**

- Sitting properly and safely
- Transporting
- Starting, shifting, parking
- Saving fuel and helping the environment
- Consumer information



#### **WARNING**

**Driving under the influence of alcohol, illegal drugs, narcotics and some medications may cause collisions and other accidents, severe personal injuries and even death.**

- Alcohol, illegal drugs, narcotics and some medications may severely affect perception, reaction times and safe driving, which may result in the loss of vehicle control.

### Getting ready and driving safely

---

 Please first read and note the introductory information and heed the **WARNINGS** 

#### **Checklist**

---

Observe the following points before and during every drive for your own safety, the safety of all passengers and others ⇒ :

- ✓ Check proper function of lights and turn signals.
- ✓ Check tire pressure (*Tires*) and fuel level (*Refueling*).
- ✓ Make sure that all windows are clean.
- ✓ Make sure that the engine is not covered by blankets or other materials and that the engine air intake is free of obstacles.
- ✓ Store items and all luggage safely in the storage compartments, in the luggage compartment and, where applicable, on the roof ⇒ *Transporting*.
- ✓ Always make sure that nothing keeps the pedals from moving freely.

- ✓ Make sure that children are properly secured by a restraint system appropriate for their size and weight ⇒ *Child safety and child restraints*.
- ✓ Properly adjust front seats, all head restraints and mirrors to the correct height ⇒ *Adjusting the seating position*.
- ✓ Wear shoes that give your feet a good grip and that give you a feel for the pedals.
- ✓ Make sure that the floormat on the driver side is properly fastened and cannot interfere with the pedals.
- ✓ Assume a proper seating position before the vehicle starts to move and keep this position while driving. Make sure that all passengers do the same ⇒ *Adjusting the seating position*.
- ✓ Properly fasten your safety belt before driving the vehicle and wear your safety belt properly at all times while driving. Make sure that all passengers do the same ⇒ *Safety belts*.
- ✓ Only transport as many passengers as there are seats and safety belts available.
- ✓ Never drive if your driving ability has been impaired, for example, by medication, alcohol, or illegal drugs.
- ✓ Never let passengers or phone calls distract you while driving and never take your attention off the road while using vehicle software or adjusting vehicle equipment or accessories.
- ✓ Always adapt your speed and driving style to visibility, weather, road, and traffic conditions.
- ✓ Always obey traffic laws and speed limits.
- ✓ On long trips make frequent rest stops – at least once every 2 hours.
- ✓ Secure animals in the vehicle with a system that corresponds to their weight and size.

### **WARNING**

**Always observe traffic rules and posted speed limits and use common sense. Your good judgment can mean the difference between arriving safely at your destination and being seriously injured in a crash or other kind of accident.**

 Regular service and maintenance of your vehicle is important both for operational and driving safety and to help prolong your vehicle's service life. Always follow the scheduled maintenance intervals in the ⇒ Booklet *Warranty and Maintenance*, especially for changing the brake fluid. Hard use, frequent stop-and-go driving, driving in very dusty areas, trailer towing, and other factors may make it necessary to have the vehicle serviced more frequently. Ask an authorized Volkswagen dealer or an authorized Volkswagen Service Facility for more information.

## Driving in other countries

 Please first read and note the introductory information and heed the WARNINGS 

### Checklist

Some countries have special safety standards and emissions requirements that your vehicle may not meet. Before taking your vehicle to another country, Volkswagen therefore recommends that you ask your authorized Volkswagen dealer or authorized Volkswagen Service Facility about the following issues with regard to the country to which you would like to travel:

- ✓ Should the vehicle be technically prepared for the trip abroad, such as masking or adjusting headlights?

- ✓ Are maintenance, repair facilities, necessary tools and testing equipment as well as spare parts readily available for your vehicle?
  - ✓ Are there authorized Volkswagen dealers and authorized Volkswagen Service Facilities in the countries where you will be driving?
  - ✓ For gasoline engines: Is unleaded fuel with the right octane rating readily available?
  - ✓ For diesel engines: Is ultra low-sulfur diesel fuel and AdBlue readily available?
  - ✓ Are engine oil ⇒ *Engine oil* and other operating fluids that meet Volkswagen quality and performance requirements available where you will be driving? For more information, please See ⇒ Booklet *Warranty and Maintenance*.
  - ✓ Does the factory installed navigation system work in the countries where you will be driving, and is navigation data available?
  - ✓ Are special or heavy-duty tires necessary for the kind of driving expected?
- 

## NOTICE

**Volkswagen is not responsible for mechanical damage that may result from substandard fuel or service or the unavailability of Genuine Volkswagen parts.**

## Driving through water on roads

---

 Please first read and note the introductory information and heed the **WARNINGS** 

Note the following to help prevent vehicle damage when driving through water, for example on flooded roads:

- Check the depth of the water before driving through it. The water **must not be any higher than** the bottom of the vehicle body ⇒ .
- Do not drive faster than walking speed.
- Never stop the vehicle, and do not drive in reverse or switch the engine off when driving through water.
- Oncoming vehicles may create waves that raise the water level and make it too deep for your vehicle to drive through safely.

## WARNING

**After driving through water, mud, sludge, etc., the brakes react slower and need longer stopping distances.**

- **Always dry the brakes and clean off any ice coatings with a few careful applications of the brake. Make sure not to endanger other motorists or cyclists or disobey legal requirements.**
- **Avoid abrupt or sudden braking maneuvers immediately after driving through water.**

## NOTICE

- **Vehicle components such as the engine, transmission, suspension or electrical system may be severely damaged by driving through water. To help prevent damage to these components, have your vehicle inspected by an authorized Volkswagen dealer or an authorized Volkswagen Service Facility after driving through water.**

- **Never drive through salt water. Salt causes vehicle corrosion. Thoroughly rinse with fresh water all vehicle parts that were exposed to salt water.**

## Technical data

### Introduction

---

In this section you'll find information about:

Important vehicle labels  
Engine data  
Dimensions

Your vehicle's engine type is shown on the vehicle label or in the official vehicle documents.

The specifications in this Manual refer to the base model. The stated values may vary, depending upon different equipment or models, as well as with respect to special vehicles and vehicles exported to different countries.

#### **More information:**

- Transporting
- Tires and wheels
- Infotainment System
- Saving fuel and helping the environment
- Fuel
- Engine oil
- Engine coolant
- Consumer information



#### **WARNING**

**Disregarding or exceeding stated values for weights, loads, dimensions and maximum speed may result in accidents and serious personal injuries.**

## Important vehicle labels



Fig. 18 Vehicle identification label: Shown in the example with engine identification code CBFA 3.

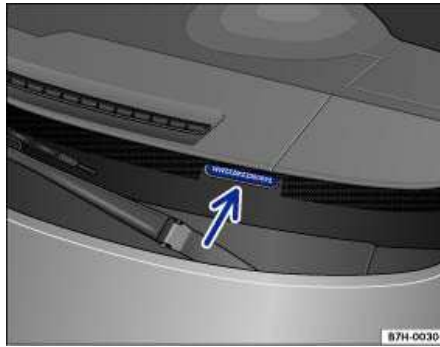

Fig. 19 Vehicle Identification Number (VIN).

### ⚠ Please first read and note the introductory information and heed the WARNINGS ⚠

Factory-installed safety certificates, stickers, and signs containing important information regarding vehicle operation can be found in the engine compartment and on certain vehicle components, such as inside the fuel filler flap, on the passenger sun visor, in the driver door jamb, or on the luggage compartment floor.

- Do not remove, alter, or render unusable or illegible any safety certificates, stickers, and labels.
- If vehicle components bearing safety certificates, stickers, or labels are replaced, make certain that the firm doing the work attaches new conforming certificates, stickers, or labels to the same part of the new components.

### Vehicle Identification Number (VIN)

The Vehicle Identification Number (VIN) is on a plate on top of the instrument panel on the driver side, and is visible from the outside through the windshield ⇒ fig. 19. The view window is on the side at the bottom of the windshield. The vehicle identification number is also stamped into the top of the right drip channel in the engine compartment. The drip channel is between the spring strut tower and the right fender. Open the engine hood to read the vehicle identification number ⚠ ⇒ *In the engine compartment.*

### Viewing the VIN in the Infotainment System

- Switch on the ignition.
- Press the **CAR** Infotainment button.
- Tap the **Settings** function key on the screen.
- Select **VIN/Number of keys** from the list.

The VIN and the number of programmed remote control vehicle keys are shown in the Infotainment System screen.

### Vehicle identification label

The vehicle identification label is on the left side of the rear panel in the luggage compartment, under the carpet on the luggage compartment floor, or at the rear of the spare wheel/tire compartment. The label contains the following information:

- (1) Vehicle Identification Number (VIN)
- (2) Vehicle type, engine output, transmission
- (3) Engine and transmission identification code, paint number, interior. In the example, the engine classification code is "CBFA"
- (4) Optional equipment, part numbers

### Safety Compliance Certification Label

A safety certificate affixed to the door jamb in the driver door confirms that at time of production all necessary safety standards and requirements of the traffic safety agency of the respective country were met. The month and year of production as well as the vehicle identification number may be listed as well.

### Radiator fan and high voltage warning sticker

A warning sticker about the radiator fan and the high voltage of the electrical system is located in the engine compartment next to the engine hood release. The vehicle ignition system complies with the Canadian standard ICES-002.

### Tire inflation pressure label

A tire inflation pressure label is on the driver door jamb ⇒ page 174, *Tires and wheels*.

### Additional high-voltage warning labels

Your vehicle also has additional warning labels that warn again touching high-voltage components ⇒ *Hybrid drive*.

## Engine data

---

Please first read and note the introductory information and heed the **WARNINGS** 

### Gasoline engine

Maximum power output	Injection technology	Engine code	Maximum torque	No. of cylinders Displacement

Maximum power output	Injection technology	Engine code	Maximum torque	No. of cylinders Displacement
280 hp at 6200 rpm 206 kW at 6200 rpm	FSI®	CGRA 3.6L	265 ft-lbs at 2900 - 4000 rpm 360 Nm at 2900 - 4000 rpm	6 cylinders 219.5 CID (3597 ccm)

#### Diesel engine

Maximum power output	Injection technology	Engine code	Maximum torque	No. of cylinders Displacement
240 hp at 3500-4000 rpm 176 kW at 3500-4000 rpm	TDI®	CNRA 3.0L	406 ft-lbs at 1750-2250 rpm 550 Nm at 1750-2250 rpm	6 cylinders 181.1 CID (2967 ccm)

#### Hybrid drive vehicle

Total power output	Injection technology	Engine code	Maximum torque (combined)	No. of cylinders Displacement
380 hp at 5500-6500 rpm 279 kW at 5500-6500 rpm	TSI®	CGFA 3.0L	428 ft-lbs at about 1000 rpm 560 Nm at about 1000 rpm	6 cylinders 182.7 CID (2995 ccm)

## Dimensions

☐ Please first read and note the introductory information and heed the WARNINGS ⚠



**All except Hybrid drive vehicles**

Length	188.8 inches (4795 mm)
Width	76.4 inches (1940 mm)
Height (unloaded)	68.2 inches (1732 mm)
Wheelbase	113.9 inches (2893 mm)
Minimum turning circle diameter	39 feet (11.9 m)
Track <sup>1</sup> , front	64.9 inches (1650 mm)
Track <sup>1</sup> , rear	65.7 inches (1670 mm)
Ground clearance	7.9 inches (200 mm) <sup>2</sup>
Approach angle – Off-road	25 degrees
Departure angle	26 degrees
Ramp angle	20 degrees
Max. gradient	31 degrees
Fording depth	Maximum 20 inches (500 mm)

**Hybrid drive vehicle**

Length	188.8 inches (4795 mm)
Width	76.4 inches (1940 mm)
Height (unloaded)	68.2 inches (1732 mm)

---

<sup>1</sup> Slight differences to these figures are possible, depending on wheel and tire size fitted and the level selected.

<sup>2</sup> Approx. figure for fully loaded standard vehicle; varies depending on your vehicle's equipment (engine, tires, wheels, tire inflation pressure, driving situation and other factors).

Wheelbase	113.9 inches (2893 mm)
Minimum turning circle diameter	39 feet (11.9 m)
Track <sup>1</sup> , front	64.5 inches (1638 mm)
Track <sup>1</sup> , rear	65.3 inches (1658 mm)
Ground clearance	7.9 inches (200 mm) <sup>2</sup>
Approach angle – Off-road	25 degrees
Departure angle	26 degrees
Ramp angle	20 degrees
Max. gradient	31 degrees
Fording depth	Maximum 20 inches (500 mm)



#### NOTICE

- Please be careful when parking your vehicle in areas with parking barriers or curbs. These vary in height and could damage your bumper and related parts if the front of your vehicle hits a barrier or curb that is too high while you are getting into or out of a parking spot.
- Always be careful when you enter a driveway or drive up or down steep ramps or over curbs or other obstacles. Parts of the vehicle close to the ground may be damaged (such as bumper covers, spoilers, and parts of the engine, suspension, and exhaust systems).

# Vehicle key set

## Introduction

---

In this section you'll find information about:

- Remote control vehicle keys
- Emergency key
- Indicator light in the remote control vehicle key
- Replacing the remote control vehicle key battery
- Synchronizing the remote control vehicle key

### More information:

- Volkswagen Information System
- Power locking and closing system
- Starting and stopping the engine
- Consumer information
- Emergency closing and opening

### DANGER

**20 mm button cells and other lithium batteries will cause serious personal injury and even death within a short time if swallowed.**

- Always keep remote control vehicle key fobs with batteries, spare batteries, as well as dead button cells and larger 20 mm batteries out of the reach of children.
- Get medical attention immediately if you suspect that a battery has been swallowed.

### WARNING

**Improper use of remote control vehicle keys can result in serious personal injury.**

- Always take the key with you when you leave the vehicle. It can be used to start the engine and operate vehicle systems such as the power windows, leading to serious personal injury. Children or other unauthorized persons could also lock the doors and the luggage compartment.
- Never leave children, disabled persons, or anyone who cannot help themselves in the vehicle. The doors can be locked with the remote control vehicle key. This could result in people being trapped in the vehicle in an emergency. For example, depending on the time of year, people trapped in the vehicle can be exposed to very high or very low temperatures.
- Heat build-up in the passenger and luggage compartment of a parked vehicle can result in temperatures in the vehicle that are much higher than the outside temperatures, particularly in summer. Temperatures can quickly reach levels that can cause unconsciousness and death, particularly to small children.
- Never remove the key from the ignition switch while the vehicle is moving or rolling to a stop. The steering wheel will lock and you will not be able to steer or control the vehicle.

## Remote control vehicle keys

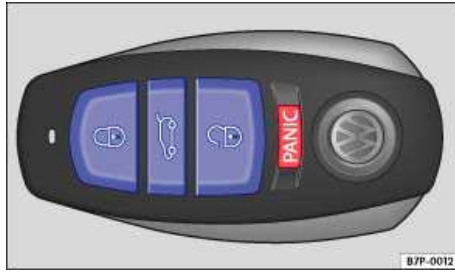

Fig. 20 Remote control vehicle key with panic button.

⚠ Please first read and note the introductory information and heed the WARNINGS ⚠

### Remote control vehicle key

The remote control vehicle key can unlock and lock the vehicle from a distance.

The remote transmitter and battery are inside the remote control vehicle key. The receiver is inside the passenger compartment. The operating range of the remote control vehicle key for a fresh battery is several yards (meters) around the vehicle.

If the remote control vehicle key will not lock or unlock your vehicle, you probably need to replace the battery in the remote control vehicle key ⇒ *Replacing the remote control vehicle key battery*. If this is not the problem, the key should be resynchronized by an authorized Volkswagen dealer, an authorized Volkswagen Service Facility, or another qualified workshop. See also ⇒ *Synchronizing the remote control vehicle key*.

### Panic button

Press button ⇒ [fig. 20](#) only in emergencies! After pressing the button, an alarm signal will sound and the turn signals will flash. Press the button again to switch off the panic feature.

### Replacement vehicle keys

The vehicle identification number is required to get a replacement key or an additional remote control vehicle key.

Up to 8 remote control vehicle keys, each of which must be properly cut, coded, programmed, and synchronized, can be used with your vehicle.

Each new vehicle key contains a microchip and must be coded with the data from the vehicle's electronic immobilizer. A vehicle key will not work if it does not contain a microchip or contains a chip that is not coded, even if the key bit was cut correctly.

You can obtain additional or duplicate remote control vehicle keys from authorized Volkswagen dealers, authorized Volkswagen Service Facilities and from certain independent repair facilities and locksmiths which are qualified to make remote control vehicle keys.

Each vehicle key must be programmed by an authorized Volkswagen dealer, an authorized Volkswagen Service Facility, or another qualified workshop in order for it to work with your vehicle.

To find the nearest qualified independent repair facility, locksmith, or Volkswagen dealer which can cut and code replacement vehicle keys, call the VW Customer Care Hotline at 1-800-822-8987 or visit <http://www.vw.com> and search for "replacement keys."

Canadian customers can contact an authorized Volkswagen dealer or Volkswagen Service Facility or call the Volkswagen Canada Customer CARE Center at (1-800-822-8987).

## NOTICE

The remote control vehicle keys contain electrical components. Protect them from damage, moisture and rough handling.

 Do not press the buttons on the remote control vehicle key unless you actually want to use the function in question. Since terrain and conditions vary, pressing a button on the remote control vehicle key when it is not necessary may unlock the vehicle or set off the panic alarm, even if you think you are out of range.

 Remote control vehicle key functions can be temporarily disrupted by interference from transmitters near the vehicle that use the same frequency range (such as radio equipment or mobile phones).

 Things between the remote control vehicle key and vehicle, bad weather, as well as a weak battery can reduce the operating range.

 If the remote control vehicle key buttons ⇒ [fig. 20](#) or the power locking buttons ⇒ [fig. 27](#) are pushed repeatedly in quick succession, the power locking system is switched off for a brief period to help keep it from being overloaded. The vehicle is then unlocked for about 30 seconds. Unless a door or the rear hatch is opened in this span of time, the vehicle is automatically locked afterwards.

## Emergency key

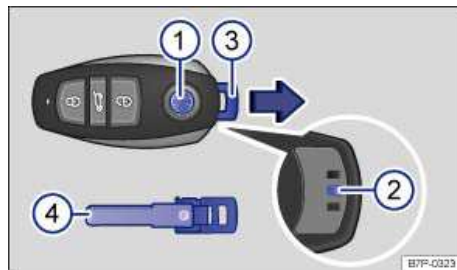

**Fig. 21** Releasing the emergency key and removing it from the remote control vehicle key.

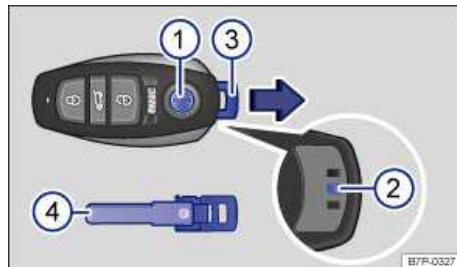

**Fig. 22** Releasing the emergency key and removing it from a remote control vehicle key with a panic button.

**⚠ Please first read and note the introductory information and heed the WARNINGS ⚠**

There is an emergency key inside the remote control vehicle key fob for manual unlocking and locking the vehicle.

- (1) Emergency key release button.
- (2) Locking catch in the remote control vehicle key.
- (3) Emergency key in the remote control vehicle key, with eyelet for fastening to a key chain.
- (4) Emergency key removed.

**Releasing and removing the emergency key**

- With one hand, press and hold button (1) ⇒ fig. 21 or ⇒ fig. 22.
- With the other hand, press the locking catch (2) under the emergency key (4) while pulling the key out in the direction of the arrow.

**Using the emergency key**

The emergency key can be used for the following:

- Locking and unlocking the glove compartment ⇒ *Storage areas*.
- Manually locking and unlocking the vehicle ⇒ *Emergency closing and opening*.

**Reinserting the emergency key**

- Insert the emergency key (4) or into the opening of the key fob.
- Slide the emergency key in the direction opposite to the arrow until it locks into place.

**Indicator light in the remote control vehicle key**

---

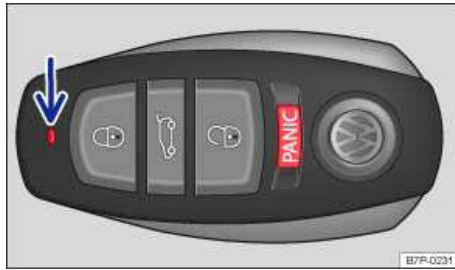

**Fig. 23** Indicator light in the remote control vehicle key.

**⚠ Please first read and note the introductory information and heed the WARNINGS ⚠**

If a button in the remote control vehicle key is pressed briefly, the indicator light (arrow) ⇒ fig. 23 will flash once briefly. If you press and hold a button, it flashes repeatedly.

If the indicator light in the remote control vehicle key does not come on when the button is pressed, the battery inside the key must be replaced ⇒ *Replacing the remote control vehicle key battery*.

A Declaration of Compliance with the United States FCC and Industry Canada regulations is found in the Consumer Information section of this Manual ⇒ *Declaration of Compliance, Telecommunications and Electronic Systems*.

## Replacing the remote control vehicle key battery

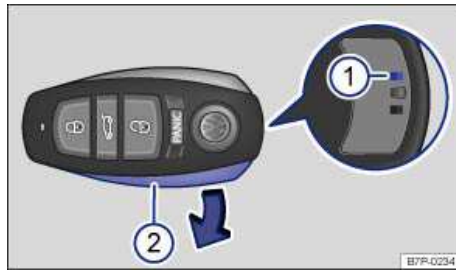

Fig. 24 Removing battery cover from the remote control vehicle key.

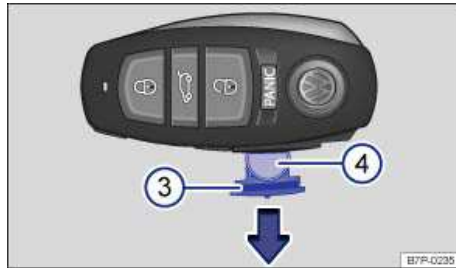

Fig. 25 Opening battery compartment of the remote control vehicle key.

### **⚠ Please first read and note the introductory information and heed the WARNINGS ⚠**

Volkswagen recommends having the battery in the remote control vehicle key changed by an authorized Volkswagen dealer or an authorized Volkswagen Service Facility.

The battery is in the remote control vehicle key under a cover ⇒ fig. 24. When changing the battery, pay attention to the correct polarity and use the same type of battery ⇒ ⚠.

### **Removing the cover**

- Take the emergency key out of the remote control vehicle key fob ⇒ page 37, *Emergency key*.
- Insert the end of a bent paper clip (or other suitable object) into the opening (1) on the back of the remote control vehicle key as far as it will go. Then press it down and towards the outer edge of the remote control vehicle key fob.
- Remove the paper clip and remove the cover (2) in the direction of the arrow.

### **Replacing the battery**

- Hold the key so that the VW emblem points up.
- Pull the battery compartment out ⇒ fig. 25 (3) in the direction of the arrow and remove the battery (4).
- Carefully place the new battery into the battery compartment slot with the flat side down.
- Push the cover as shown ⇒ fig. 25 and press it down (opposite to direction of the arrow) until you hear it click into place.
- Push the battery compartment in the direction opposite to the arrow ⇒ fig. 25 back into the remote control vehicle key fob.

## Replacing the cover

- Insert the thin left side of the cover ⇒ [fig. 24 \(2\)](#) in the remote control vehicle key and press the thick right side down until the cover locks into place.
- Reinsert the emergency key into the remote control vehicle key ⇒ *Emergency key*.

## NOTICE

- **Changing the battery improperly can damage the remote control vehicle key.**
- **Using the wrong battery can damage the remote control vehicle key. Replace a dead battery with a new one that has the same voltage, size, and specifications.**
- **Make sure the plus and minus poles of the battery are correctly positioned.**



Dispose of old batteries in an environmentally responsible manner and keep them out of the reach of children.



Batteries of the type used in your remote control vehicle key may contain **Perchlorate Material**. Special handling may apply – see <http://www.dtsc.ca.gov/hazardouswaste/perchlorate>. Obey all legal requirements regarding handling and disposal of these batteries. Authorized Volkswagen dealers and authorized Volkswagen Service Facilities are familiar with the requirements, and we recommend that you have them perform this service for you.

## Synchronizing the remote control vehicle key

 Please first read and note the introductory information and heed the **WARNINGS** 

If the button  is pressed often while outside the operating range, it is possible that the vehicle cannot be locked or unlocked anymore with the remote control vehicle key. Synchronize the vehicle key as follows:

### Synchronizing the remote control vehicle key when the vehicle is closed

- Take the emergency key out of the remote control vehicle key fob ⇒ *Emergency key*.
- Remove the cap from the door handle on the driver door ⇒ *Emergency closing and opening*.
- Manually unlock the vehicle with the emergency key within 1 minute.
- Switch the ignition on with the remote control vehicle key fob. The synchronization is complete.
- Put the emergency key in the remote control vehicle key fob and reinstall the cap.

### Synchronizing the remote control vehicle key when the vehicle is open

Turn the ignition on with the remote control vehicle key fob. The synchronization is complete.



# Power locking and closing system

## Introduction

---

In this section you'll find information about:

- Indicator light in the driver door
- Description of the power locking system
- Unlocking and locking the vehicle from the outside
- Unlocking and locking the vehicle from the inside
- Unlocking or locking vehicles with Keyless Access
- Anti-theft alarm system

The power locking system works properly only when all doors and the rear hatch are completely closed. When the driver door is open, the vehicle *cannot* be locked with the remote control vehicle key.

For vehicles equipped with the Keyless Access locking and starting system, the vehicle can be locked *only* if the ignition is switched off and the driver door is closed.

Leaving the vehicle unlocked for longer periods of non-use (for example, in your garage) can cause the vehicle battery to drain so that the engine can no longer be started.

### **More information:**

- Exterior views
- Volkswagen Information System
- Vehicle key set
- Doors
- Rear hatch
- Power windows
- Power sunroof
- Trailer towing
- Emergency closing and opening

## WARNING

Improper use of power locks can result in serious personal injury.

- The power locking button locks all doors. Locking the doors from the inside can help prevent unintended door opening during a collision and can also prevent unwanted entry from the outside. Locked doors can, however, delay assistance to vehicle occupants and rescue from the outside in an accident or other emergency.
- Never leave children or anyone who cannot help themselves behind in the vehicle. All doors can be locked from the inside with the power lock button. This could leave people trapped in the vehicle in an emergency. Depending on the time of year, people trapped in the vehicle can be exposed to very high or very low temperatures.
- A closed vehicle can become very hot or very cold, depending on the season. Particularly in the summer, heat buildup in the passenger and luggage compartment of a parked vehicle can result in temperatures in the vehicle that are much higher than the outside temperatures. Temperatures can quickly reach levels that can cause unconsciousness and death, particularly to small children.
- Never allow passengers to remain in a locked vehicle. In an emergency any person still inside the vehicle might not be able to get out.

## Indicator light in the driver door

 Please first read and note the introductory information and heed the WARNINGS 

The indicator light for the power locking system is in the driver door ⇒ *Passenger compartment*.

After the vehicle is locked	Meaning
The red LED light flashes for about 2 seconds in short intervals, then slower.	The vehicle is locked.
Red LED light flashes for about 2 seconds in short intervals, then lights up continuously for about 30 seconds.	Locking system malfunction. See an authorized Volkswagen dealer or an authorized Volkswagen Service Facility.

## NOTICE

Failure to heed warning lights or text WARNINGS can result in vehicle damage.

## Description of the power locking system

 Please first read and note the introductory information and heed the WARNINGS 

The power locking system lets you unlock and lock all doors and the rear hatch.

- From the outside with the vehicle key.

- From the outside with Keyless Access ⇒ *Unlocking or locking vehicles with Keyless Access.*
- From the inside with the power locking switch ⇒ *Unlocking and locking the vehicle from the inside.*

The doors and the rear hatch can be locked manually if the remote control vehicle key is not working.

### Automatic locking (Auto lock)

The vehicle will lock automatically when it reaches a speed of about 10 mph (15 km/h). When the vehicle is locked, the indicator light  comes on in the power locking button ⇒ [fig. 27](#).

### Automatic unlocking (Auto unlock)

All doors automatically unlock when you switch off the ignition and open a door from inside the vehicle. On vehicles with automatic transmission, the doors will also unlock when the selector lever is in Park (P) and the ignition is switched off. Auto unlock works only if the vehicle has been automatically locked with the Auto lock feature. The indicator light  goes out in the power locking button when the doors unlock ⇒ [fig. 27](#).

### Switching functions on and off in the Infotainment System

Certain power locking feature can be turned on and off in the Infotainment System.

- Switch on the ignition.
- Press the **CAR** Infotainment button.
- Tap the **Settings** function key on the screen.
- Select **Central locking** from the list.

If the check box in the function key is checked , the feature is switched on.

### Function key: supplementary information

---

**Lock automatically**: Automatically locks all doors and the rear hatch at a speed of about 9 mph (15 km/h). To unlock when the vehicle is not moving, press the power locking switch or take the key out of the ignition. Tap the function key to deactivate the feature.



---

**Confirmation tone**: The horn beeps once to confirm that the vehicle is locked. Tap the function key to deactivate the feature.

---

**Fold in mirrors**: Automatically folds in the outside mirrors when the vehicle is locked. Tap the function key to deactivate the feature.

---

**Unlock doors**: Controls options for unlocking doors with the  button in the remote control vehicle key. Tap the function key **Unlock doors** or  and select the desired option in the pop-up window.

**All**: All doors and (possibly) the rear hatch are unlocked when the vehicle is unlocked with the remote control vehicle key.

## Function key: supplementary information

**Driver only**: Only the driver's door is unlocked when the vehicle is unlocked with the remote control vehicle key. All doors and (possibly) the rear hatch open only if the  button is pushed a second time.

**Unlock trunk separately**: The rear hatch remains locked when the vehicle is unlocked. Pressing the  button unlocks the rear hatch. Tap the function key to deactivate the feature.

### Locking the vehicle after airbag inflation

If the airbags are activated during a collision, the entire vehicle is unlocked. Depending on the severity of the damage, the vehicle can be locked after a collision when the airbags have deployed as follows:

Function	Action
Locking the vehicle <b>with the power locking switch</b> :	<ul style="list-style-type: none"><li>– Switch the ignition off.</li><li>– Open a door once.</li><li>– Press power locking switch .</li></ul>
Locking the vehicle <b>with the remote control vehicle key</b> :	<ul style="list-style-type: none"><li>– Switch the ignition off and on again.</li></ul> <p><b>OR:</b> Remove the remote control vehicle key from the ignition.</p> <ul style="list-style-type: none"><li>– Open a door once.</li><li>– Lock the vehicle with the remote control vehicle key.</li></ul>

 If the remote control vehicle key buttons ⇒ *Remote control vehicle keys* or one of the power locking buttons ⇒ *Unlocking and locking the vehicle from the inside* are pushed repeatedly in quick succession, the power locking system is switched off for a brief period to help keep it from being overloaded. The vehicle is then unlocked for about 30 seconds. Unless a door or the rear hatch is opened during this time, the vehicle is automatically locked afterwards.

## Unlocking and locking the vehicle from the outside

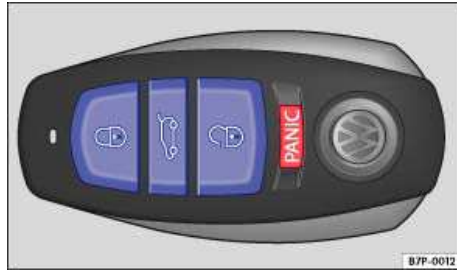





Fig. 26 Buttons in the remote control vehicle key.

⚠ Please first read and note the introductory information and heed the WARNINGS ⚠

Function	Using the buttons on the remote control vehicle key ⇒ fig. 26	Using the emergency key
Unlock the vehicle.	Press the  button twice to open all doors and the rear hatch.	Insert the emergency key into the driver door lock and turn counterclockwise.
Lock the vehicle.	Press the  button.	Insert the emergency key into the driver door lock and turn clockwise.
Unlock the rear hatch.	Press the  button.	

**Note:** Depending on the settings for the power locking system in the **Central locking** sub-menu, it may be necessary to press the  button twice to unlock all doors and the rear hatch ⇒ *Switching functions on and off in the Infotainment System*.

The remote control vehicle key unlocks and locks the vehicle only when the battery in the remote control vehicle key have enough power, and the remote control vehicle key is within a few yards/meters of the vehicle.

- All turn signals flash once and the horn beeps once to confirm that the vehicle has been locked. The horn beep can be disabled by deactivating the “Confirmation tone” feature in the **Central locking** sub-menu ⇒ *Switching functions on and off in the Infotainment System*.
- All turn signals flash *twice* to confirm that the vehicle has been unlocked.

If the turn signals *do not* flash to confirm locking, one or more doors, the rear hatch or the engine hood is not locked.

If the driver door is open, the vehicle cannot be locked with the remote control vehicle key.

If the vehicle was unlocked with the remote control vehicle key and the door or the rear hatch has not been opened in about 30 seconds, the vehicle is automatically locked again. This feature helps prevent the vehicle from staying unlocked unintentionally.

## Unlocking and locking the vehicle from the inside

---





Fig. 27 On all 4 doors: Power locking switch.

ⓘ Please first read and note the introductory information and heed the WARNINGS ⚠

**Press button ⇒ fig. 27:**

---

 Unlock the vehicle.

 Lock the vehicle.

---

The power locking switch works whether the ignition is switched on or off, but only when all doors are closed.

If the vehicle is locked with the remote control vehicle key, the power locking switch is deactivated.

If the vehicle is locked with the power locking switch:

The indicator light  in the power locking switch comes on ⇒ fig. 27 to indicate that all doors and the rear hatch are locked.

- The anti-theft alarm system is **not** turned on.
- Opening doors or the rear hatch from the *outside* is not possible, at a traffic light, for example.
- Doors can be unlocked and opened separately from inside the vehicle by pulling the door handle to open the door. The indicator light  goes out. The unopened doors and rear hatch remain locked and cannot be opened from the outside.
- An open driver door will not be locked. This helps keep the driver from being locked out of the vehicle.

The vehicle is unlocked if you push the  button while the vehicle is standing still. Depending on the settings in the **Central locking** sub-menu ⇒ *Switching functions on and off in the Infotainment System*, it may also be unlocked when you take the vehicle key out of the ignition or, on vehicles with Keyless Access, when you open the driver door (**Auto. open**).

## Unlocking or locking vehicles with Keyless Access

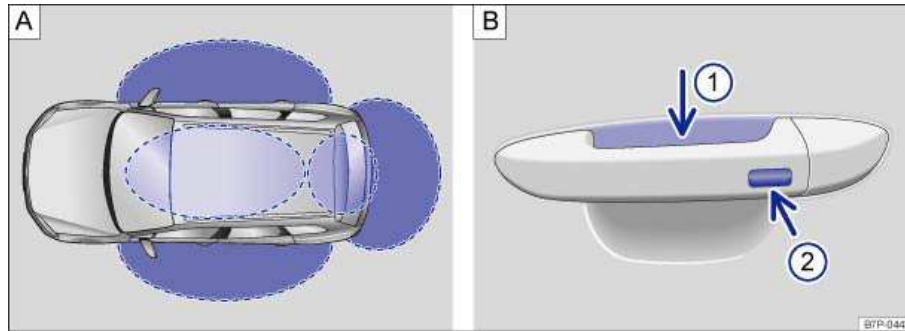

**Fig. 28 A:** Ranges of the Keyless Access locking and starting system. Outside the vehicle: Unlocking range. Inside the vehicle: starting range. **B:** Keyless Access locking and starting system: Sensor 1 for unlocking on the inside of the front door handles. Sensor for locking on the outside of the door handles 2.

### **ⓘ Please first read and note the introductory information and heed the WARNINGS ⚠**

Keyless Access is a keyless starting and locking system that unlocks and locks the vehicle without active use of a remote control vehicle key. All you have to do is have a valid vehicle key within range ⇒ [fig. 28 A](#) and touch a sensor surface on one of the front door handles ⇒ [fig. 28 B](#) or push the button on the rear hatch ⇒ *Rear hatch* when a valid vehicle key is within range ⇒ .

### **General information**

When a valid vehicle key comes within range ⇒ [fig. 28](#), the Keyless Access locking and starting system recognizes a valid vehicle entry request as soon as a door handle sensor is touched on the driver or front passenger door or the button on the rear hatch is pressed. The following functions are then enabled without active use of the vehicle key:

- Keyless Entry: Unlocking the vehicle with the sensor surfaces on the door handles of the driver or front passenger door (1) is pressed or by using the button on the rear hatch.
- Keyless Go: Start engine and drive. For this, you just have to press the starter button and have a valid remote control vehicle key inside the vehicle.
- Keyless Exit: Locking the vehicle via the door handle of the driver or front passenger door.
- Easy Open: Opening the rear hatch by moving your foot below the rear bumper ⇒ *Sensor-controlled rear hatch opener (Easy Open)*

The power locking and closing system works like the *standard* unlocking and locking system. Only the way that the systems are operated is different.

All turn signals flash twice to confirm that the vehicle has been unlocked and once to confirm that it has been locked.

If the vehicle was unlocked and within the next few seconds no door or the rear hatch has been opened, the vehicle is automatically locked again.

### **Unlocking and opening doors (Keyless Entry)**

- Grasp the door handle of the driver or front passenger door so that you touch the unlocking sensor surface (1) **B**. When doing so, **do not** contact the sensor on the door handle (2) **B**.
- Open the door.

### Closing and locking doors (Keyless Exit)

- Switch off the ignition.
- Close the driver door.
- Touch the sensor surface in the door handle on the driver or front passenger door ⇒ [fig. 28 \(2\) B](#) *once*. The vehicle is locked. The door being locked must be closed.

### Unlocking and locking the rear hatch (Keyless Entry for the rear hatch)

If the vehicle is locked and a valid vehicle key is within range ⇒ [fig. 28 A](#) of the rear hatch, it unlocks automatically when opened.

- Open and close the rear hatch as you would a standard rear hatch ⇒ *Rear hatch*.

The rear hatch locks automatically when it is closed except in the following situations:

- The vehicle is completely unlocked.
- When an authorized vehicle key is inside the vehicle.

### Locking with a second vehicle key

If a remote control vehicle key is inside the passenger compartment, the vehicle can be locked from the outside only if a second valid key is within range.

When the vehicle is locked from the outside, the keyless go (starting) function of any keys left in the passenger compartment will be deactivated. All other functions (remote central locking and unlocking as well as emergency starting) remain active and unchanged.

A key that was inside the vehicle when it was locked from the outside is reactivated:

- By pressing a button on the deactivated key.
- By pressing a door handle sensor when the deactivated key is outside of the vehicle, but within range.
- By starting the engine with the starter button on the front center console.

### Automatic deactivation of sensors

If the vehicle has not been unlocked or locked for a longer period of time, the proximity sensors in the passenger door are automatically deactivated.

If a sensor on the door handle of a locked vehicle is activated too often, for instance by a bush or hedge that rubs against the vehicle, the sensors in the door handle on that side of the vehicle are switched off for 30 minutes.

The sensors become active again when the vehicle is locked with the vehicle key and the ignition is switched on one time.

The sensors become active again if one of the following events occurs:

- 30 minutes have passed.
- **OR:** The vehicle is unlocked using the  button in the remote control vehicle key.
- **OR:** The rear hatch is opened.
- **OR:** The vehicle is mechanically unlocked using the emergency vehicle key.

### Convenience features

To use the convenience closing feature to close all power windows, hold your finger on the lock sensor surface [\(2\)](#) on the outside of the door handle for a few seconds until the windows close.

Remove your finger from the lock sensor surface [\(2\)](#) to stop the function. If you touch the unlock sensor surface 1 on the inside of the door handle immediately after releasing the lock sensor surface 1 (arrow), all of the windows will open (safety function). Pinch protection is active during convenience closing of the windows.

The settings in the **Settings – Convenience** menu ⇒ *Volkswagen Information System* determine which doors open when the door handle sensor surface is touched.





## NOTICE

The door handle sensor surfaces can be activated by a strong stream of water or steam if a valid vehicle key is within range of the vehicle. All windows may open if you turn the spray of water or steam away from and then back onto the door handle sensor surface in quick succession.



The door may not open if the outside and inside door handles are used at the same time.



If the automatic transmission is **not** in Park (**P**) position, the electronic steering column lock will not lock and the vehicle will not lock via sensors in the front door handles or the remote control vehicle key.



If the vehicle battery or the battery in the remote control vehicle key is weak or dead, it might not be possible to unlock and lock the vehicle using Keyless Access. The vehicle can still be manually locked or unlocked with the emergency key ⇒ *Opening and closing*.



The driver message **Key not in range** appears in the instrument cluster display if there is no remote control vehicle key inside the vehicle or if the system does not recognize the remote control vehicle key. The key may not be recognized, for example, if it is covered by something that interferes with the signal (such as a briefcase), or if the remote control vehicle key battery is weak. Electronic devices such as mobile phones can also interfere with the signal.



Dirt on the door handles that contains a lot of salt (especially in winter) can affect the way the door handle sensors work. Cleaning the door handles can help with this problem ⇒ *Exterior care and cleaning*.

## Anti-theft alarm system

---

 **Please first read and note the introductory information and heed the WARNINGS**

Your vehicle is either equipped with an anti-theft alarm system or pre-equipped for anti-theft alarm system installation. If the vehicle is pre-equipped for installation of the anti-theft alarm system, the alarm system can be retrofitted by an authorized Volkswagen dealer or an authorized Volkswagen Service Facility.

The anti-theft alarm system makes it more difficult for someone to break into or steal the vehicle.

The anti-theft alarm system is automatically activated when the vehicle is locked by pressing the lock button on the remote control vehicle key.

### When is the alarm triggered?

The anti-theft alarm system sounds for about 30 seconds and flashes the turn signals for up to 5 minutes, if the following occurs with respect to the locked vehicle:

- Opening a door that has been mechanically unlocked.
- Forcibly opening a door.
- Forcibly opening the engine hood.
- Forcibly opening the rear hatch.
- Switching on the ignition with an invalid key.
- Disconnecting the vehicle battery.



- Disconnecting an anti-theft system integrated trailer ⇒ *Trailer towing*.

### Deactivating the alarm

Unlock the vehicle with the unlock button on the remote control vehicle key and switch on the ignition with a valid remote control vehicle key.

For vehicles with Keyless Access, the alarm can be deactivated by grasping one of the door handles when a valid vehicle key is in range or by holding the remote control vehicle key to the right of the steering column trim and pressing the starter button ⇒ *Unlocking or locking vehicles with Keyless Access*.

 After the alarm has stopped and the vehicle is opened again in the same or a different area that is protected by the alarm, the alarm is triggered again. For example, the alarm will sound again if the rear hatch is opened after one of the doors has been opened.

 The anti-theft alarm system is **not** activated when the vehicle is locked with the power lock switch  on the inside of the driver or front passenger doors.

 If the driver door is mechanically unlocked with the emergency key, only the driver door is unlocked, but not the entire vehicle. Switching on the ignition deactivates the anti-theft alarm system and activates the central locking button. To unlock the doors, use the central locking button or remote control vehicle key.

 If the vehicle battery is dead or weak, the anti-theft alarm system will not work properly.

## Doors

### Introduction

---

In this section you'll find information about:

Warning light

Electric child safety locks

#### More information:

- Exterior views
- Vehicle key set
- Power locking and closing system
- Power windows
- Emergency closing and opening

#### WARNING

A door that is not closed properly may open suddenly when the vehicle is moving and cause severe injuries.

- Stop immediately and close the door.
- Make sure that the door is safely and completely latched when closed. The closed door must be flush with the surrounding auto body parts.
- Open or close doors only if no one is in the way.

#### WARNING



A door kept open with the door stop may close in strong winds or on inclines and cause injuries.

- Always hold doors by the door handle while opening and closing.

### Warning light

---

 Please first read and note the introductory information and heed the WARNINGS 

Lights up	Possible cause	Proper response
	At least one vehicle door is open or improperly closed.	 <b>Stop!</b> Open and close the door again.

When the ignition is switched on, several warning and indicator lights come on briefly for a function check. They go out after a few seconds.

If a door is not closed properly, the  warning light in the instrument cluster comes on showing an open door.

Depending on vehicle options, a symbol may be displayed in the instrument cluster instead of the warning light. The symbol will still be displayed even after the ignition is switched off. The instrument cluster display goes out about 15 seconds after the vehicle has been locked.

## Electric child safety locks

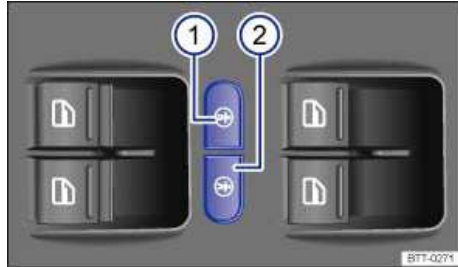

**Fig. 29** In the driver door: Buttons for the electric child safety locks.

**⚠ Please first read and note the introductory information and heed the WARNINGS **

The electric child safety locks keep the rear doors from being opened from the inside, so that children cannot open them accidentally. The rear power window switch for the selected side is also disabled. The controls for the power windows and door locks can be operated separately (left or right) to prevent restrictions being placed on an adult passenger seated in the back with a child. The left button ⇒ [fig. 29 \(1\)](#) and the right button [\(2\)](#) switch the child safety lock on for either the left or right side, respectively.

A yellow indicator light in the button comes on to indicate activation.

### Activating or deactivating electric child safety locks

Function	Response
Activate:	Press the left button or the right button, light comes on ⇒ <a href="#">fig. 29</a> .
Deactivate:	Press the respective button again, light goes out.



## **WARNING**

When the electric child safety lock is engaged, that rear door cannot be opened from the inside.

- Never leave children, disabled persons, or anyone who cannot help themselves, in the vehicle when locking the doors. This could result in people being locked in the vehicle. This could result in people being trapped in the vehicle in an emergency. Depending on the time of year, people trapped in the vehicle can be exposed to very high or very low temperatures.
- A closed vehicle can become very hot or very cold, depending on the season. Particularly in the summer, heat build-up in the passenger and luggage compartment of a parked vehicle can result in temperatures in the vehicle that are much higher than the outside temperatures. Temperatures can quickly reach levels that can cause unconsciousness and death, particularly to small children.

## Rear hatch

### Introduction

---

In this section you'll find information about:

Warning light

Opening the rear hatch

Power operation of the rear hatch

Sensor-controlled rear hatch opener (Easy Open)

#### More information:

- Exterior views
- Power locking system
- Sensor-controlled rear hatch opener (Easy Open)
- Transporting
- Emergency closing and opening

#### WARNING

Accidents and severe personal injuries can result if you unlock, open, or close the rear hatch when someone is in the way.

- Only open or close the rear hatch if no one is in the way.
- After closing the rear hatch, always make sure that it is properly closed and locked so that it cannot open suddenly when the vehicle is moving. The closed rear hatch must be flush with the surrounding auto body parts.
- Always keep the rear hatch closed while driving to help keep poisonous exhaust gas from being drawn into the vehicle.
- Never open the rear hatch when a luggage rack is installed and loaded. If, for example, there are bicycles on a carrier on the rear hatch, it is possible that the lid will not be able to open automatically. An open rear hatch may fall on its own because of the additional weight. The open rear hatch must be supported or the weight must be removed from the luggage rack first.
- Close and lock the rear hatch and all doors when the vehicle is not in use. First, make sure that no one is left inside the vehicle.
- Never leave your vehicle unattended or let children play around your vehicle, especially when the rear hatch is open. A child could crawl into the vehicle and pull the rear hatch shut, becoming trapped and unable to get out. A closed vehicle can become very hot or very cold, depending on the season. Particularly in the summer, heat build-up in the passenger and luggage compartment of a parked vehicle can result in temperatures in the vehicle that are much higher than the outside temperatures. Temperatures can quickly reach levels that can cause unconsciousness and death, particularly to small children.
- Never leave children or anyone who cannot help themselves behind in the vehicle. They may lock the vehicle with the vehicle key or the power locking switch and lock themselves in.

 **NOTICE**



Before opening or closing the rear hatch, make sure there is enough room to do so, as for example when the vehicle has a trailer or is in a garage.

 **NOTICE**

Never use the gas strut or the power rear hatch to hold or clamp a load in place. This can damage the rear hatch and make it impossible to close.

## Warning light

 Please first read and note the introductory information and heed the **WARNINGS** 

Lights up	Possible cause	Proper response
 <b>OR</b> icon appears in the display	Rear hatch open or improperly closed.	 <b>Stop!</b> Open the rear hatch and then close it again.

When the ignition is switched on, several warning and indicator lights come on briefly for a function check. They go out after a few seconds.

If the rear hatch is not closed properly, the red  warning light comes on in the instrument cluster display or the vehicle icon appears in the instrument cluster showing an open rear hatch.

Depending on vehicle options, a symbol may be displayed in the instrument cluster instead of the warning light. The symbol will still be displayed even after the ignition is switched off. The Premium instrument cluster display goes out about 15 seconds after the vehicle has been locked.

 **WARNING**

**If the rear hatch is not closed properly, it may open suddenly when the vehicle is moving and cause severe injuries.**

- Stop immediately and close the rear hatch.
- Always make sure the rear hatch is securely latched after you close it.

## Opening the rear hatch



Fig. 30 In the driver door: Power button to unlock the rear hatch.



Fig. 31 Opening rear hatch from the outside.

ⓘ Please first read and note the introductory information and heed the WARNINGS ⚠

If there are bicycles on a mounted luggage rack, it may not be possible to open the rear hatch ⇒ ⚠. Remove items from the luggage rack and support the open rear hatch.

### Unlocking and opening with the remote control vehicle key

Press and hold the  button on the remote control vehicle key to automatically open the rear hatch.

### Unlocking and opening with the unlock switch on the driver door

Pull up the  switch on the driver door until the rear hatch opens automatically ⇒ fig. 30.

The switch in the driver door also works when the ignition is switched off.

### Opening with the button on the rear hatch

- Unlock the vehicle or the rear hatch, or open a door.
- Lift the rear hatch slightly while standing near the button ⇒ fig. 31 (arrow). The rear hatch opens automatically.

## ⚠ WARNING

Improper and unsupervised unlocking or opening of the rear hatch can cause severe injuries. Never open the rear hatch when someone is in the way.

- If a bicycle or luggage rack is installed on the rear hatch, it may be hard to see that the rear hatch is unlatched. An unlatched rear hatch may open suddenly when the vehicle is moving.



## NOTICE

Before opening or closing the rear hatch, make sure there is enough room to do so, as for example when the vehicle has a trailer or is in a garage.

 At temperatures below +32 °F (0 °C), the rear hatch may not open automatically after you unlock it. It will be necessary to lift it by hand.

## Power operation of the rear hatch

---

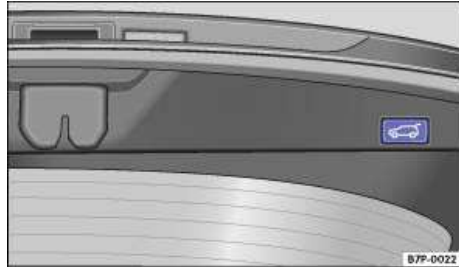



Fig. 32 Button in the open rear hatch.

 Please first read and note the introductory information and heed the WARNINGS 

### More information:

- Sensor-controlled rear hatch opener (Easy Open) ⇒ *Sensor-controlled rear hatch opener (Easy Open)*.

### Opening rear hatch (Comfort opening)



- Press the  button on the remote control vehicle key for about a second until the rear hatch automatically opens.
- **OR:** Pull the  switch in the driver door up ⇒ [fig. 30](#).
- **OR:** Operate the switch ⇒ [fig. 31](#) (arrow) on the outside of the rear hatch.

If, while opening automatically, the rear hatch encounters resistance or becomes blocked by an obstacle, it will immediately stop opening.

The rear hatch cannot be opened automatically via its power feature if the factory-installed trailer hitch is electrically connected with the trailer.

The rear hatch can be opened by hand with some force.

### Closing the rear hatch (Comfort closing)

- Press the  button in the remote control vehicle key for about a second.
- **OR:** Pull the  switch in the driver door up ⇒ [fig. 30](#).
- **OR:** Operate the switch ⇒ [fig. 31](#) (arrow) on the outside of the rear hatch.
- **OR:** Press the button in the open rear hatch ⇒ [fig. 32](#) ⇒ .
- **OR:** Move by hand the rear hatch toward the closed position.



The rear hatch will then move into closing position by itself and will be closed by the soft-close feature ⇒ .

If, while closing automatically, the rear hatch meets resistance or becomes blocked by an obstacle, it will reopen slightly.

Check to see why the rear hatch could not close.

Try again to close the rear hatch.

#### Canceling the opening or closing feature

You can stop the opening or closing of the rear hatch by pressing one of the  buttons a second time. Pressing one of the  buttons again makes the hatch move back to its original position.

You can then open the hatch further by hand. This requires some strength.

#### Saving the opening angle

The rear hatch must be at least half way open to be able to save the opening angle.

- Stop the opening process at the desired opening angle
- Press the ⇒ [fig. 32](#) button in the open rear hatch ⇒  for at least 3 seconds. This saves the opening angle.

The warning flashers will blink and a chime will sound to confirm that the angle has been saved.

To completely open the rear hatch again you must first save a new opening angle.

- Unlock the rear hatch and open it to the saved position.
- Manually push open the rear hatch as far as it will go. This requires some strength.
- Press the ⇒ [fig. 32](#) button in the open rear hatch for at least 3 seconds.
- The opening angle has been reset to the factory setting.

#### WARNING

**Improper or unsupervised closing of the rear hatch can cause severe injuries.**

- **Never leave your vehicle unattended or let children play around your vehicle, especially with the rear hatch left open. A child could crawl into the vehicle and pull the rear hatch shut, becoming trapped and unable to get out. A closed vehicle can become very hot or very cold depending on the season. Temperatures can quickly levels that can cause unconsciousness or death, particularly to small children.**

#### WARNING

**A closed rear hatch cannot open completely and an open rear hatch cannot close automatically if a luggage rack is installed on it or if it is covered by a heavy layer of snow. In this case, you will have to hold the rear hatch or prop it up to keep it open.**

#### NOTICE

**Before opening or closing the rear hatch, make sure there is enough room to do so, as for example when the vehicle has a trailer or is in a garage.**

#### NOTICE

- **Remove any luggage or bicycle rack mounted on the rear hatch before opening the hatch.**

## ! NOTICE

If the system is operated too often in succession, it will shut itself off to help prevent overheating.

- The feature can be used again as soon as the system has cooled down. In the meantime, the rear hatch can be opened or closed by hand, though this requires some strength.
- If the vehicle battery or the fuse is blown when the rear hatch is open, the rear hatch system must be reset. To reset the rear hatch, it must be closed once.



Make sure that the remote control vehicle key is not in the luggage compartment before closing the rear hatch.

## Sensor-controlled rear hatch opener (Easy Open)

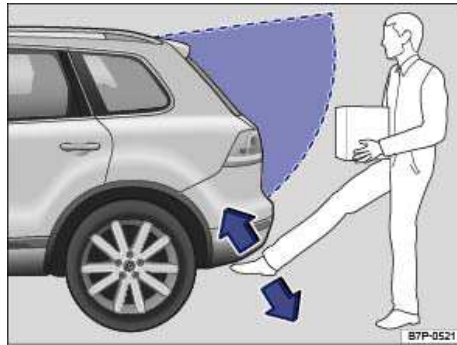

Fig. 33 Keyless Access locking and starting system: Opening the sensor-controlled rear hatch (Easy Open).

### ⓘ Please first read and note the introductory information and heed the WARNINGS ⚠

If your vehicle has Keyless Access, it may also be equipped with the Easy Open feature.

When a valid vehicle key is within range of the rear hatch ⇒ fig. 28 (A), the rear hatch can be unlocked and opened by moving your foot within the sensor's range ⇒ fig. 33 below the rear bumper.

- Switch off the ignition and remove any vehicle key from the ignition.
- Stand about 2 ft. (60 cm) behind the middle of the rear bumper.
- Quickly move your foot under the middle of the rear bumper in a “kicking” motion.
- Move your foot back so that you are standing firmly on both feet again. It is not necessary to contact the vehicle when you make this “kicking” motion.
- The high-mounted brake light and the turn signals flash once to show that the Easy Open feature is opening the rear hatch.
- The rear hatch opens in about 2 seconds.

If the rear hatch does not open, wait a few seconds and try again.

The rear hatch locks automatically after closing if the vehicle was locked before and a valid vehicle key is not inside the vehicle.

Easy Open may not work properly or at all in the following situations (examples):

- If the rear bumper is very dirty.
- If the rear bumper has salty water on it after driving on salted roads.
- If a trailer hitch/ball mount has been installed on the vehicle.

Easy Open may be automatically deactivated in heavy rain to help prevent unintentional deployment caused by water running down the vehicle, for example.

 **WARNING**

**Careless use of the Easy Open feature can cause falls and serious personal injury**

- Always make sure you have firm footing when using the Easy Open feature, and that the surface you are standing on is not uneven or slippery.
- Always remember that it will be necessary for you to move backwards to let the rear hatch open. Be careful not to lose your balance, particularly when holding things in your hands.
- Never use Easy Open feature unless you can use it safely.

 **CAUTION**

If a valid vehicle key is within range of the rear hatch, the Easy Open feature can deploy unintentionally in some cases and open the rear hatch: for example, when sweeping the ground or floor below the rear bumper, if there is a strong stream of water or steam or when carrying out maintenance or repairs around the rear bumper. If the rear hatch opens unintentionally, it can injure anyone or damage anything in its way.

- Never leave a valid vehicle key within range of the rear hatch unattended.

## Power windows

### Introduction

---

In this section you'll find information about:

Opening and closing power windows

Power windows – features

Power window pinch protection

#### More information:

- Volkswagen Information System
- Power locking and closing system

### WARNING

Improper use of power windows can result in serious personal injury.

- Never let anyone get in the way of a power window when closing it.
- When locking the vehicle from the outside, make sure that no one, especially children, remains in the vehicle. The windows will not open in case of an emergency.
- Always take the key with you when you leave the vehicle. You can still use the power windows for several minutes after the ignition is switched off as long as the driver or front passenger door has not been opened.
- Always use the safety switch when children are in the back seat to disable the rear power windows and keep them from being opened and closed.

### NOTICE

If you leave the windows open, rain or other precipitation may enter the vehicle from outside and can damage the vehicle interior.

### Opening and closing power windows

---

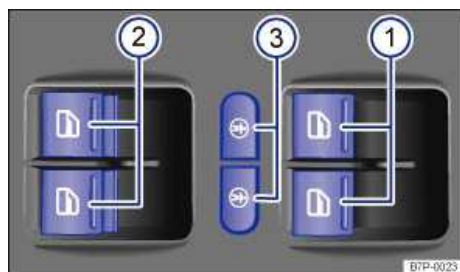

Fig. 34 In driver door: Safety control switches for front and rear power windows.



 Please first read and note the introductory information and heed the WARNINGS 

### Switches in the driver door

Key to fig. 34:

- (1) For the windows in the front doors.
- (2) For the windows in the rear doors.
- (3) Safety switches.

### Opening or closing windows

Function	Action
Opening:	Press the  switch.
Closing:	Pull the  switch.
Stopping automatic movement:	Press/pull the switch again.
	The safety switch (left/right) (3) deactivate the left hand and right hand power windows in the rear doors. The yellow indicator light in the switch lights up when activated. The electric child safety locks also prevent the rear doors from being opened from the inside.

The power windows operate only when the ignition is switched on.

You can still use the power windows for several minutes after the ignition is switched off as long as the driver or front passenger door has not been opened. When the vehicle key has been removed from the ignition and the driver door has been opened, the power windows cannot be opened or closed.

 A separate button for controlling the window is located in the front passenger door.

## Power windows – features

 Please first read and note the introductory information and heed the WARNINGS 

### One-touch opening and closing

The one-touch feature automatically opens/closes a power window all the way. The window switch does not have to be held down/up.

**For one-touch opening:** Press the switch for the window down briefly as far as it goes.

**For one-touch closing:** Pull the switch for the window up briefly as far as it goes.

**Stopping automatic movement:** Pull/press the switch again.

### Reactivating the one-touch feature

If the vehicle battery is disconnected or dead and the windows are not completely closed, the one-touch feature will not work and must be reactivated:

- Close all windows and doors.
- Pull up the switch for the respective window and hold it for at least 2 seconds in this position.
- Release the switch, pull up and hold again. The one-touch feature is now reactivated.

The one-touch feature can be reactivated for one or more windows at the same time.

### Convenience closing

From outside the vehicle (vehicles with Keyless Access), hold your finger on the lock sensor surface on the outside of the door handle for a few seconds until the windows close ⇒ page 47.

Convenience closing closes the windows first and then the power sunroof.

 <b>WARNING</b>	
<b>Improper use of power windows can result in serious personal injury.</b>	
<ul style="list-style-type: none"><li>• <b>Never let anyone get in the way of a power window when closing it.</b></li><li>• <b>When locking the vehicle from the outside, make sure that no one, especially children, remains in the vehicle. The windows will not open in case of an emergency.</b></li><li>• <b>Always take the key with you when you leave the vehicle. You can still use the power windows for several minutes after the ignition is switched off as long as the driver or front passenger door has not been opened.</b></li><li>• <b>Always use the safety switch when children are in the back seat to disable the rear power windows and keep them from being opened and closed.</b></li></ul>	

 If the power windows malfunction, the one-touch feature, as well as pinch protection will not work properly. See an authorized Volkswagen dealer or an authorized Volkswagen Service Facility right away.

## Power window pinch protection

 **Please first read and note the introductory information and heed the WARNINGS **

Pinch protection can help reduce the risk of pinching injuries when closing a power window ⇒ . If one-touch window closing meets resistance or there is something in the way, the window will stop and go down again.

- Check why the window did not close.
- Try one-touch window closing again.
- If the window meets resistance a second time, so that it stops and goes back down, one-touch closing is deactivated for about 10 seconds.
- If you pull the power window button up all the way and hold it during this 10 second interval, the window will close **without pinch protection** ⇒ .

### Closing the window without pinch protection

- Try to close the window again within 10 seconds by holding the switch. **Pinch protection is turned off for a short distance in the window track!**

- If closing takes longer than about 10 seconds, pinch protection is turned on again. The window stops again if there is resistance.
- If the window still will not close, please see an authorized Volkswagen dealer or an authorized Volkswagen Service Facility.

 **WARNING**

**Without pinch protection, power windows will close with enough force to cause serious personal injury.**

- **Always be careful when closing power windows.**
- **Always make sure that no one is in the way when overriding pinch protection to close power windows!**
- **Pinch protection cannot prevent fingers or other parts of the body from being pressed against the window frame; injuries may result.**

 Pinch protection is also active during convenience closing of the windows and the power sunroof  
⇒ *Power windows – features.*



# Power sunroof

## Introduction

---

In this section you'll find information about:

Opening or closing the power sunroof

Opening or closing the power sunshade

Power sunroof – convenience closing feature

Pinch protection for the power sunroof and the sunshade

Initializing the power sunroof

### More information:

- Volkswagen Information System
- Power locking and closing system
- Roof rack
- Emergency closing and opening

### WARNING

**Improper use of the power sunroof can result in serious personal injury.**

- **Always make sure that no one is in the way of the power sunroof when it is closing.**
- **Always take the key with you when you leave the vehicle.**
- **Never leave children or disabled persons in the vehicle – particularly if they have access to the vehicle key. Unsupervised use of the remote control vehicle key makes it possible to lock the vehicle, start the engine, turn on the ignition and operate the sunroof.**
- **You can still open or close the power sunroof for several minutes after you switch off the ignition, as long as the driver or front passenger door has not been opened.**

### NOTICE

- **To help prevent damage, remove ice and snow from the sunroof before opening it in winter weather.**
- **Always close the sunroof before leaving the vehicle or if it begins raining. If the sunroof is open, rain could enter the vehicle interior and cause extensive damage to the electrical system. This could result in further vehicle damage.**

 Remove leaves and other objects from the sunroof guide rails regularly either by hand or using a vacuum cleaner.

 If the power sunroof malfunctions, pinch protection does not function properly. See an authorized Volkswagen dealer or an authorized Volkswagen Service Facility.

## Opening or closing the power sunroof

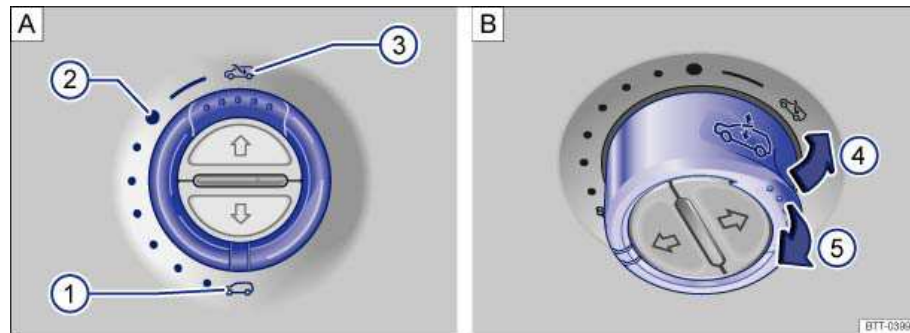

**Fig. 35** In the headliner: Rotary switch for the power sunroof. A: Turn the rotary switch to slide the sunroof open or closed. B: Press or pull the switch to tilt open or to close.

**⚠ Please first read and note the introductory information and heed the WARNINGS ⚠**

The rotary switch must be turned to its home position (1) in order to tilt the power sunroof.

Function	Switch position	Action
	⇒ fig. 35 A	
To open sliding sunroof fully:	(3)	Turn the switch past position (2) and hold it there until the glass roof moves to the desired position.
To move the sliding sunroof to Comfort position:	(2)	Turn the switch to the desired position.
To set an intermediate position:	(2) to (1)	
To close the sliding sunroof fully:	(1)	
	⇒ fig. 35 B	
To tilt open the tilting roof fully:	(4)	Push the rear part of the switch briefly.

Function	Switch position	Action
To stop the one-touch feature:	(4) or (5)	Push or pull switch again briefly.
To set an intermediate position:	(4) to (5)	Pull or push the rear part of the switch briefly until the desired position is reached.
To close fully:	(5)	Pull the rear part of the switch briefly.

The power sunroof only works when the ignition is on. You can still open or close the power sunroof for several minutes after you switch off the ignition, as long as the driver or front passenger door has not been opened.

All procedures are interrupted as soon as the rotary switch is operated.

The sunshade opens automatically when the power sunroof opens if the shade was previously completely closed or in front of the glass roof. The sunshade remains in the previous position and does not close automatically with the sunroof. The sunshade cannot be closed completely until the power sunroof is closed.

If your power sunroof will not close properly, do not try to close it yourself, doing so can cause serious and expensive damage that will not be covered by any Volkswagen Limited Warranty. Special knowledge and tools are required to close the power sunroof if it will not close on its own. To help prevent damage to the sunroof, have an authorized Volkswagen dealer or an authorized Volkswagen Service Facility help you close and repair the power sunroof.



The comfort position (2) provides sufficient ventilation without loud wind noise.

## Opening or closing the power sunshade

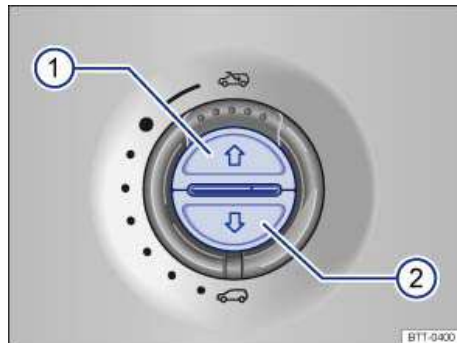

Fig. 36 In the headliner: Buttons for sunshade.

**ⓘ** Please first read and note the introductory information and heed the WARNINGS 

Function	Response
To open fully (one-touch feature):	Briefly press the ⇒ fig. 36 (1) button.
To stop the one-touch feature:	Briefly press the ⇒ fig. 36 (1) button or the (2) button.
To set an intermediate position:	Keep the ⇒ fig. 36 (1) button or (2) button pressed until the position has been reached.
To close fully (one-touch feature):	Briefly press the ⇒ fig. 36 (2) button.

You can still use the sunshade for several minutes after the ignition is switched off as long as the driver or passenger door has not been opened.

When the power sunroof is completely open the sunshade is automatically moved to a ventilation position.

When the power sunroof is in the tilt position the sunshade will also open a small gap.



When the power sunroof is open, the electrical sunshade can only be closed up to the front edge of the glass roof.

## Power sunroof – convenience closing feature

ⓘ Please first read and note the introductory information and heed the WARNINGS ⚠

### Convenience closing

On vehicles with Keyless Access the convenience closing feature lets you close the power sunroof as follows:

- Hold your finger on the lock sensor surface on the outside of the door handle for a few seconds until the windows and power sunroof close ⇒ *Unlocking or locking vehicles with Keyless Access*.

Convenience closing first closes the windows and then the power sunroof.



Convenience closing of the power sunroof from the outside leaves the rotary switch in the last selected position. The switch must be newly positioned when starting to drive again.

## Pinch protection for the power sunroof and the sunshade

ⓘ Please first read and note the introductory information and heed the WARNINGS ⚠

Pinch protection can help reduce the risk of pinching injuries when closing the power sunroof and the sunshade ⇒ . If the power sunroof or the sunshade closing meets resistance or there is something in the way, the sunroof and sunshade open again immediately.

- Check why the power sunroof or the sunshade did not close.
- Try to close the power sunroof or the sunshade again.
- If the power sunroof or the sunshade still cannot close, the sunroof or sunshade will stop where the resistance is located. The power sunroof or the sunshade will close the next time without pinch protection.

#### Opening and closing the power sunroof without pinch protection

- The switch ⇒ [fig. 35](#) must be rotated to the “Closed” position (1) **A**.
- *Power sunroof*: Within 5 seconds after the pinch protection was triggered, pull the rear part of the switch ⇒ [fig. 35 \(5\) B](#) until the sunroof is fully closed.
- *Sunshade*: Within 5 seconds after the pinch protection was triggered, press the ⇒ [fig. 36 \(2\)](#) switch until the sunshade is fully closed.
- **The power sunroof or sunshade will now close without pinch protection!**
- If the power sunroof still will not close, please see an authorized Volkswagen dealer or an authorized Volkswagen Service Facility.

If you let go of the switch while the roof is closing, the power sunroof opens automatically.

 **WARNING**

**Without pinch protection, the power sunroof and sunshade will close with enough force to cause serious personal injury.**

- **Always be careful when closing the power sunroof.**
- **Always make sure that no one is in the way when overriding the pinch protection to close the power sunroof or the sunshade!**
- **Pinch protection cannot prevent fingers or other parts of the body from being pressed against the edge of the roof; injuries may result.**

 Pinch protection is also active during convenience closing of the windows and the power sunroof ⇒ *Convenience closing*.

 If the power sunroof malfunctions, pinch protection may not function properly. See an authorized Volkswagen dealer or an authorized Volkswagen Service Facility for assistance.

## Initializing the power sunroof

---

 Please first read and note the introductory information and heed the **WARNINGS** 

#### Initializing the sunroof

If the vehicle battery has been disconnected or is dead, the sunroof must be initialized.

- The switch ⇒ [fig. 35](#) must be rotated to the “Closed” position (1) **A**.
- Pull the switch at the rear until the sunroof is fully closed.
- **The power sunroof or sunshade will now close without pinch protection!**
- Release the switch.

- Pull and hold the switch at the rear. The sunroof will open and close on its own.
- When the sunroof is closed once again, release the switch.
- If the sunroof still will not close, contact an authorized Volkswagen dealer or an authorized Volkswagen Service Facility.

 **WARNING**

Careless or unsupervised use of the sunroof can cause serious injuries.

- Always make sure that no one is in the way of the power sunroof when it is closing.
- Always take all vehicle keys with you when leaving the vehicle.
- Never leave children or persons requiring assistance unattended in the vehicle, especially if they have access to the vehicle key. Unsupervised use of the remote control vehicle key can lock the vehicle, start the engine, switch on the ignition and operate the sunroof.
- The sunroof can still be opened or closed for a short period after the ignition has been switched off, as long as the driver or passenger door is not opened.

 **WARNING**

Closing the sunroof without pinch protection can cause severe injuries.

- Always be careful when closing the sunroof.
- Always make sure that no one is in the way when overriding pinch protection to close the sunroof.
- Pinch protection does not prevent fingers or other body parts from being pressed against the roof frame, thereby causing injury.

 If the sunroof malfunctions or pinch protection does not operate properly. See an authorized Volkswagen dealer or an authorized Volkswagen Service Facility for assistance.

 If the power sunroof malfunctions, pinch protection may not function properly. See an authorized Volkswagen dealer or an authorized Volkswagen Service Facility for assistance.

# HomeLink® Universal Transmitter

## Introduction

---

In this section you'll find information about:

Programming the HomeLink® Universal Transmitter

Operating the HomeLink® Universal Transmitter

The HomeLink Universal Transmitter in your vehicle can be used to open/close an automatic garage door or gate, activate a house alarm, or control a lighting system or other devices. Such devices usually come with a hand-held remote control that sends a signal to a controller to operate the device.

These instructions will help you program the HomeLink® Universal Transmitter in your vehicle so that you will not have to use the hand-held remote control that was supplied with the garage door opener or other device, inside your vehicle.

### **Fixed code or rolling code**

The garage door opener or other device may work with either a fixed or rolling code. For garage door openers or other devices with rolling codes, the HomeLink® Universal Transmitter must be synchronized *after* programming the device

### **Compatibility**

Volkswagen recommends that you consult an authorized Volkswagen dealer or authorized Volkswagen Service Facility about compatible devices **before you buy** a garage door opener or other device that you want to control with the HomeLink Universal Transmitter.

The HomeLink Universal Transmitter can be programmed to the radio frequency codes of most current hand-held remote controls.

Safety switches are mandatory for garage door openers.

A Declaration of Compliance with the United States FCC and Industry Canada regulations is found in the Consumer Information section of this Manual ⇒ *Declaration of Compliance, Telecommunications and Electronic Systems*.

### **DANGER**

**20 mm button cells and other lithium batteries will cause serious personal injury and even death within a short time if swallowed.**

- **Always keep hand-held remote control devices with batteries, spare batteries, as well as dead button cell and larger 20 mm batteries out of the reach of children.**
- **Get medical attention immediately if you suspect that a battery has been swallowed.**

## **⚠ WARNING**

Improper use of the HomeLink Universal Transmitter can cause serious or even fatal personal injury.

- Garage doors operate with enough force to cause serious personal injury.
- Never let anyone get in the way of a garage door when it is opening or closing.
- When programming the HomeLink Universal Transmitter, you may be operating a garage door or estate gate. Always make sure that people and objects are out of the way to help prevent serious personal injury or property damage.
- When operating the “training” button on a garage door opener with a rolling code, you will need to stand on a ladder or step stool. Always take extra precautions to prevent falls and serious injury.
- Never use the HomeLink Universal Transmitter with any garage door opener that does not have the safety stop-and-reverse feature, as required by federal safety standards. This includes any garage door opener model manufactured before April 1, 1982.
- A garage door opener that cannot detect an object, signaling the door to stop and reverse, does not meet current federal safety standards. Using a garage door opener without these features increases the risk of serious injury or death.
- Follow the installation manual and the included safety information from the manufacturer when using the remote controlled garage door opener or electrical drive.

## Programming the HomeLink® Universal Transmitter

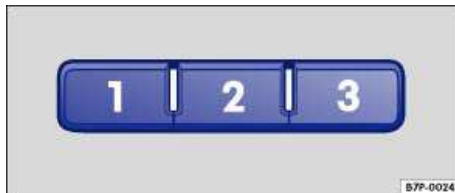

Fig. 37 Roof keypad: Buttons for the HomeLink Universal Transmitter.



Fig. 38 Infotainment System: HomeLink Universal Transmitter menu.

ⓘ Please first read and note the introductory information and heed the WARNINGS ⚠



The buttons **1**, **2**, and **3** on the roof keypad ⇒ [fig. 37](#) between the sun visors can operate up to 3 separate remote control devices (for example, a gate and garage door, a house alarm, or a lighting system).

### Getting ready to program

- Please read the product manufacturer's instructions **before** programming the garage door opener or other device.
- Safely park the vehicle within range of the device to be programmed.
- Switch the ignition on, but do not start the engine.

### Menu Garage door opener in the Infotainment System

Call up the Garage door opener menu in the Infotainment System ⇒ [fig. 38](#).

- Press the **CAR** Infotainment button.
- Tap the **Settings** function key on the screen.
- Select **Garage door opener** from the list.

### Function key: Effect

---

**Program buttons**: Buttons **1**, **2** or **3** can be programmed after you tap the function key. Follow the instructions on the Infotainment System screen.

---

**Delete button assignment**: Deletes the programming of buttons **1**, **2**, and **3** ⇒ [fig. 37](#).

---

**Version information**: Most recent programming information for your authorized Volkswagen dealer or authorized Volkswagen Service Facility.

### Programming information

You must complete the programming process within 5 minutes. If you exceed this time limit, the programming is cancelled.

If programming is cancelled, a red LED lights up in the keypad and the turn signals flash once.

### Programming unassigned buttons

- Complete the programming preparation steps described above ⇒ page 73.
- Press unassigned button in the roof keypad ⇒ [fig. 37](#).
- Follow the instructions on the Infotainment System screen.

The orange LED in the keypad also blinks to indicate that programming is in progress.

If programming is successful, a green LED in the keypad will light up and the turn signals will flash 3 times.

Repeat these steps with another unassigned garage door opener button to use that button to control another device.

### Programming previously assigned buttons

- Complete the programming preparation steps described above ⇒ page 73, *Getting ready to program*.
- Press the **CAR** Infotainment button.
- Tap the **Settings** function key on the screen.
- Select **Garage door opener** from the list.
- Tap the **Program button** function key and follow the instructions on the Infotainment System screen.

The orange LED in the keypad also blinks to indicate that programming is in progress.

If programming is successful, a green LED in the keypad will light up and the turn signals will flash 3 times.

Repeat these steps with another previously assigned garage door opener button to use that button to control another device.

### Deleting programming for all buttons

Be sure to delete the programming on all buttons on the sun visor keypad before selling the vehicle or turning it over to people you do not know.

- Switch on the ignition.
- Press the **CAR** Infotainment button.
- Tap the **Settings** function key on the screen.
- Select **Garage door opener** from the list.
- Tap the **delete button assignment** function key and confirm.

The green LED in the keypad will light up to confirm that the programming has been successfully deleted.

### After programming

Test the garage door opener

## Operating the HomeLink® Universal Transmitter

**⚠ Please first read and note the introductory information and heed the WARNINGS ⚠**

- The vehicle must be in operating range of the garage or outer gate drives.
- With ignition turned on or engine running, press the appropriate button on the sun visor ⇒ ⚠.

The range of the HomeLink® Universal Transmitter roughly corresponds to the range of the original remote control of the device or the electrical drive. If the garage door or the electrical drive does not work, this could be for one of the following reasons:

Malfunction	Possible cause	Possible remedy
Garage door or electrical drive does not work.	Distance or transmission angle too great.	Try different distances and angles to the receiver.

Malfunction	Possible cause	Possible remedy
	Garage door or electrical drive not compatible.	May not comply with legal requirements and may have to be replaced.
	Incorrect programming.	Reprogram the garage door opener.

 **DANGER**

20 mm button cells and other lithium batteries will cause serious personal injury and even death within a short time if swallowed.

- Always keep hand-held remote control devices with batteries, spare batteries, as well as dead button cell and larger 20 mm batteries out of the reach of children.
- Get medical attention immediately if you suspect that a battery has been swallowed.

 **WARNING**

Improper use of the HomeLink® Universal Transmitter can cause serious or even fatal personal injury.

- Garage doors operate with enough force to cause serious personal injury.
- Never let anyone get in the way of a garage door when it is opening or closing.
- When programming the HomeLink® Universal Transmitter, you may be operating a garage door or estate gate. Always make sure that people and objects are out of the way to help prevent serious personal injury or property damage.
- When operating the “training” button on a garage door opener with a rolling code, you will need to stand on a ladder or step-stool. Always take extra precautions to prevent falls and serious injury.
- Never use the HomeLink® Universal Transmitter with any garage door opener that does not have the safety stop-and-reverse feature, as required by federal safety standards. This includes any garage door opener model manufactured before April 1, 1982.
- A garage door opener that cannot detect an object, signaling the door to stop and reverse, does not meet current federal safety standards. Using a garage door opener without these features increases the risk of serious injury or death.
- Follow the installation manual and the included safety information from the manufacturer when using the remote-controlled garage door opener or electrical drive.

 **NOTICE**

The wrong batteries can damage the hand-held remote control. Replace a dead battery with one that has the same voltage, size, and specifications.



Please dispose of old batteries properly and in an environmentally responsible manner. Always keep them out of the reach of children.



Certain batteries used in hand-held remote controls are classified as **Perchlorate Material**. Special handling may apply – see <http://www.dtsc.ca.gov/hazardouswaste/perchlorate>. Obey all legal requirements regarding proper disposal. Authorized Volkswagen dealers and authorized Volkswagen Service Facilities are familiar with the requirements, and we recommend that you have them perform this service for you.

# Adjusting the seating position

## Introduction

---

In this section you'll find information about:

Examples of improper seating positions

Proper seating position

Electrical controls on the driver and passenger seats

Adjusting the front seats in the Volkswagen Information System

Adjusting the rear seat

Adjusting front and rear head restraints

Removing and reinstalling head restraints

Adjusting the steering wheel position

Center armrest

### Number of seats

The vehicle has a total of **5** seating positions: 2 in front and 3 in the rear. Each seating position has a safety belt.

### More information:

- Seat functions
- Safety belts
- Airbag system
- Child safety and child restraints
- Infotainment System



### WARNING

**Improper seating positions increase the risk of severe or fatal injuries in a crash or other accidents, especially when the airbag deploys.**

- **All occupants must sit properly and properly restrained at all times.**
- **Never let more people ride in the vehicle than there are seating positions with safety belts available.**
- **Always secure children in the vehicle with an approved and suitable restraint system appropriate for their age, weight, and height *Child safety and child restraints, Airbag system.***
- **Always keep your feet on the floor in front of the seat. Never rest them on the seat, instrument panel, out of the window, etc. The airbag system and safety belt will not be able to protect you properly and can even increase the risk of injury in a crash.**

 **WARNING**

Always adjust seat, safety belts and head restraints properly before driving and make sure that all passengers are properly restrained.

- Push the passenger seat as far back as possible. Always be sure that there are at least 10 inches (25 cm) between the front passenger's breastbone and the instrument panel.
- Always adjust the driver's seat and the steering wheel so that there are a distance of 10 inches (25 cm) between your breastbone and the center of the steering wheel.
- Adjust the driver's seat so that you can easily push the pedals all the way to the floor while keeping your knee(s) slightly bent. The distance to the instrument panel in the knee area must be at least 4 inches (10 cm).
- If these requirements cannot be met for physical reasons, contact an authorized Volkswagen dealer or an authorized Volkswagen Service Facility to see whether adaptive equipment is available.
- Always hold the steering wheel on the outside of the steering wheel rim with your hands at the 9 o'clock and 3 o'clock positions to help reduce the risk of personal injury if the driver's airbag inflates.
- Never hold the steering wheel at the 12 o'clock position or with your hands at other places inside the steering wheel rim or on the steering wheel hub. Holding the steering wheel the wrong way can cause serious injuries to the hands, arms, and head if the driver's airbag inflates.
- Pointing the steering wheel toward your face decreases the ability of the driver's airbag to help protect you in a collision.
- Never drive with backrests reclined or tilted back farther than necessary to drive comfortably. The farther back the backrests are tilted the greater the risk of injury caused by incorrect positioning of the safety belts and improper seating position.  
from the steering wheel and the instrument panel.
- Always sit upright with your back against the backrest with the front seats properly adjusted. Never lean against or place any part of your body too close to the area where the airbags are located.
- Rear seat passengers who are not properly seated and restrained are more likely to be seriously injured in a crash.

 **WARNING**

Improper adjustment of the seats can cause accidents and severe injuries.

- Never adjust the seats while the vehicle is moving. Your seat may move unexpectedly and you could lose control of the vehicle. In addition, you will not be in the correct seating position while adjusting the seat.
- Adjust the front seat height, angle and longitudinal direction only if the seat adjustment area is clear.
- The adjustment of the front seats must not be restricted by things in the footwell in front of or behind the seats.



## WARNING

Some kinds of cigarette lighters can be lit unintentionally, or crushed causing a fire that can result in serious burns and vehicle damage.

- Always make sure that there are no lighters in the seat tracks or near other moving parts before adjusting the seats.
- Before closing a storage compartment, always make sure that no cigarette lighter can be activated, crushed, or otherwise damaged.
- Never leave a cigarette lighter in a storage compartment, on the instrument panel or in other places in the vehicle. Heat buildup in the passenger and luggage compartment of a parked vehicle can result in temperatures in the vehicle that are much higher than the outside temperatures, particularly in summer. High temperatures could cause the cigarette lighter to catch fire.

## Examples of improper seating positions

---

 Please first read and note the introductory information and heed the WARNINGS 

Not wearing or improperly fastening safety belts increases the risk of severe or fatal injuries. Safety belts can work only when they are properly positioned on the body. An improper seating position significantly impairs the protection provided by safety belts. This can cause severe or even fatal injuries. Improper seating positions also increase the risk of serious injury or death when an airbag deploys and strikes an occupant who is not in the proper seating position. The driver is responsible for all passengers and especially children riding in the vehicle.

The following are only some examples of seating positions that will increase the risk of serious injury or death.

**Therefore, whenever the vehicle is moving:**

- Never stand up in the vehicle.
- Never stand on the seats.
- Never kneel on the seats.
- Never ride with the seat backrest reclined.
- Never lean up against the instrument panel.
- Never lie down on the rear seat.
- Never sit on the edge of the seat.
- Never sit sideways.
- Never lean out the window.
- Never put your feet out the window.
- Never put feet on the instrument panel.
- Never rest your feet on the seat cushion or back of the seat.
- Never ride in the footwell.
- Never sit or stand on an armrest.
- Never ride without your safety belt properly fastened.
- Never ride in the luggage compartment.

## **⚠ WARNING**

Contact with parts of the vehicle interior can cause serious personal injury in a crash.

- Always make sure that all vehicle occupants stay in a proper seating position and are properly restrained whenever the vehicle is moving.
- Improper seating positions increase the risk of serious and fatal injury, especially when an airbag deploys and strikes a passenger in an improper seating position.

## **Proper seating position**

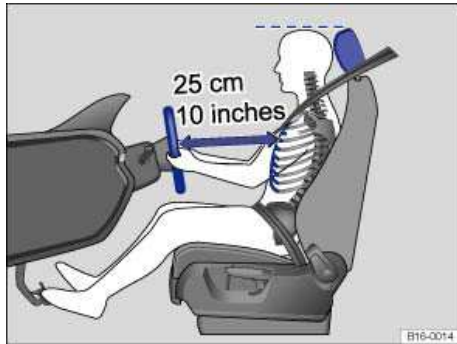

**Fig. 39** The driver should never sit closer than 10 inches (25 cm) of the steering wheel.

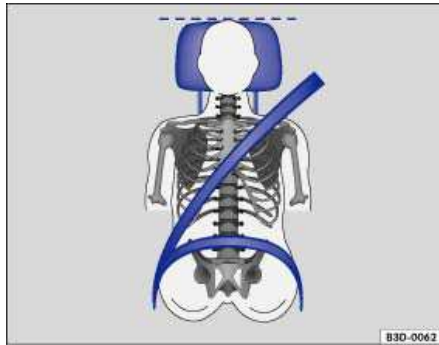

**Fig. 40** Proper safety belt positioning and head restraint adjustment.

**⚠ Please first read and note the introductory information and heed the WARNINGS ⚠**

The following describes the proper seating positions for the driver and passengers.

If you have a physical impairment or condition that prevents you from sitting properly on the driver seat with the safety belt properly fastened and reaching the pedals, special modifications to your vehicle may be necessary. Only the proper seating position ensures optimum protection by the safety belt and airbag.

Contact your authorized Volkswagen dealer or authorized Volkswagen Service Facility or call the Volkswagen Customer CARE Center at 1-800-822-8987 for information about possible modifications to your vehicle.



For your own safety and to reduce injuries in the event of sudden braking maneuvers or accidents, Volkswagen recommends the following seating positions:

**Applies to all vehicle occupants:**

- Adjust head restraints so that the upper edge of the head restraint is at least at eye level or higher. Position the back of your head as close as possible to the head restraint ⇒ [fig. 39](#) and ⇒ [fig. 40](#).
- Push the head restraint completely down for short people, even if the top of the head is then below the upper edge of the head restraint.
- Tall people should pull the head restraint all the way up.
- Adjust the seat backrest angle to an upright position so that your back is in full contact with it when the vehicle is moving.
- Always keep both feet on the floor and in the footwell whenever the vehicle is moving.
- Always adjust and fasten safety belts properly ⇒ *Safety belts*.

**Driver - seat and steering wheel adjustment:**

- Adjust the steering wheel so that there are at least 10 inches (25 cm) between the steering wheel and your breast bone ⇒ [fig. 39](#). When adjusting the proper distance to the steering wheel, grasp the top of the steering wheel with your elbows slightly bent.
- Always hold the steering wheel on the outside of the steering wheel rim with your hands at the 9 o'clock and 3 o'clock positions to help reduce the risk of personal injury if the driver's airbag inflates.
- Never hold the steering wheel at the 12 o'clock position or with your hands at other places inside the steering wheel rim or on the steering wheel hub. Holding the steering wheel the wrong way can cause serious injuries to the hands, arms, and head if the driver's airbag inflates.
- Adjust the steering wheel so that the steering wheel cover points at your chest and not at your face. Pointing the steering wheel toward your face decreases the ability of the driver's airbag to help protect you in a collision.
- Adjust the driver's seat so that you can easily push the pedals all the way to the floor while keeping your knee(s) slightly bent.
- Adjust the seat height so that the top point of the steering wheel can be reached.
- Always keep both feet in the footwell so that you are in control of the vehicle at all times.

**Passenger - front seat adjustment:**

- Push the passenger seat as far back as possible in order to ensure optimum protection if the airbag is deployed.

## Electrical controls on the driver and passenger seats

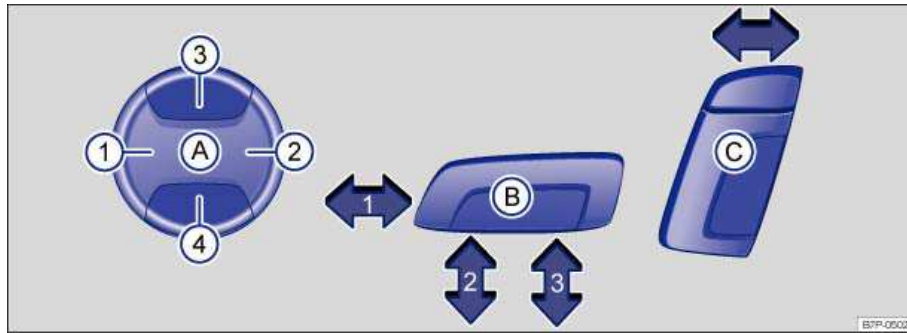

Fig. 41 Driver seat: controls to adjust lumbar support A, seat cushion B, and seat back rest angle C.

**⚠ Please first read and note the introductory information and heed the WARNINGS**

The controls on the front passenger seat mirror those on the driver seat.

There may be manual and electrical controls on the same seat.

**Key to ⇒ fig. 41 Press or move the control in the direction of the arrow or in the area shown.**

(A)	(1) or (2)	Adjust lumbar support. (1) inflates, (2) deflates.
	(3) or (4)	Adjust lumbar support height. (3) moves the lumbar support up, (4) moves the lumbar support down.
(B)	(1)	Slide the seat backward or forward.
	(2) and (3)	Raise or lower the seat cushion.
	(2) or (3)	Adjust seat cushion angle.
(C)	<i>Forward or backwards.</i>	Adjust backrest angle.

## WARNING

Improper use of electrical seat controls can cause serious personal injuries.

- The front seats in your vehicle can be electrically adjusted even when the vehicle key has been removed from the ignition or, on a vehicle with Keyless Access, even if there is no key in the vehicle.
- Never leave children and persons who need help in the vehicle alone because the unsupervised use of the electric seat adjustments can result in serious personal injury.
- Always make sure that no one is in the way while the front seats are being adjusted, or while calling up the stored memory settings for the front seats. In an emergency, stop automatic seat adjustment by pressing a seat adjustment switch.

## NOTICE

To help prevent damage to electrical parts in the seats, do not kneel on the front seats or apply concentrated pressure to a small area of the seat or backrest.

 If the vehicle battery is too weak, the electrical seat adjustment controls may not work.

 When entering and exiting the vehicle, be careful not to come into contact with any switches that could change the seat adjustment.

 Starting the engine stops seat adjustment.

## Adjusting the front seats in the Volkswagen Information System

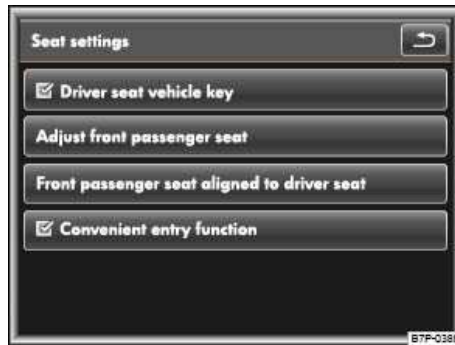

Fig. 42 Infotainment system: Menu seat settings for the driver and passenger seat with memory feature.

 Please first read and note the introductory information and heed the WARNINGS 

### Seat settings menu in the Infotainment System

- Press the **CAR** Infotainment button.
- Tap the **Settings** function key on the screen.
- Select **Seat settings** from the selection list.

### Function key: supplementary information

---

**Driver seat remote control key:** When the check box on the display screen is activated , the remote control vehicle key that is in use is activated for the memory feature.

---

**Adjust front passenger seat:** After tapping the function key, the front passenger seat can be adjusted using the driver seat controls.

---

**Front passenger seat aligned to driver seat:** After tapping the function key, driver seat adjustment can be applied to the front passenger seat. To do this, press and hold the **Adjust front passenger seat** function key.

### WARNING

Improper use of electrical seat controls can cause serious personal injuries.

- The front seats in your vehicle can be electrically adjusted even when the vehicle key has been removed from the ignition or, on a vehicle with Keyless Access, even if there is no key in the vehicle.
- Never leave children and persons who need help in the vehicle alone because the unsupervised use of the electric seat adjustments can result in serious personal injury.
- Always make sure that no one is in the way while the front seats are being adjusted, or while calling up the stored memory settings for the front seats. In an emergency, stop automatic seat adjustment by pressing a seat adjustment switch.

### NOTICE

To help prevent damage to electrical and pneumatic parts in the seats, do not kneel on the front seats or apply concentrated pressure to a small area of the seat or backrest.

 If the vehicle battery is too weak, the electrical seat adjustment controls may not work.

 Starting the engine stops seat adjustment.

 When entering and exiting the vehicle, be careful not to come into contact with any switches that could change the seat adjustment.

## Adjusting the rear seat

---

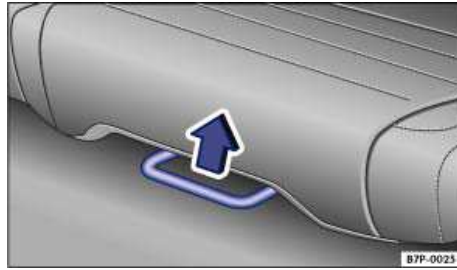

Fig. 43 Moving the left rear seat forwards and backwards.



Fig. 44 Adjusting angle of left rear seat backrest.

**⚠ Please first read and note the introductory information and heed the WARNINGS ⚠**

The rear seat is divided asymmetrically into 2 sections. Each section can be adjusted separately. You can slide the rear seat backwards and forwards and adjust the angle of the rear seat backrest.

### Moving the rear seat backwards and forwards

- Pull the adjuster lever up in the direction of the arrow ⇒ fig. 43.
- Slide the rear seat backwards or forwards ⇒ ⚠.
- Release the adjuster lever and move the rear seat slightly backwards or forwards until it locks into place.

### Adjusting rear seat backrest angle

- Pull the adjuster lever up in the direction of the arrow ⇒ fig. 44.
- Fold the rear seat back into the loading position and then backwards into the desired position (2 positions to choose from).
- Release the adjuster lever and move the rear seat forwards or backwards slightly until it locks into place.

## **⚠ WARNING**

Improper adjustment of the rear seats can cause severe personal injury.

- Adjust the rear seat only when the vehicle is stopped, since the seat could otherwise move unexpectedly when the vehicle is moving.
- Adjust the rear seat only if no one is in the way.
- Always guide the backrest down by hand and never let it fall into place on its own.

## **ⓘ NOTICE**

- Items in the luggage compartment could be damaged or cause damage when the rear seat is adjusted in the fore and aft direction.
- If the rear seat is in a forward position, items can get into the area between the seat and the luggage compartment floor. When you slide the rear seat back again, make sure that the area behind the seat is clear of objects.

## Adjusting front and rear head restraints

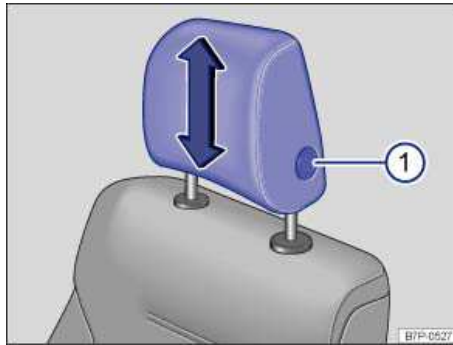

Fig. 45 Adjusting the front head restraints.

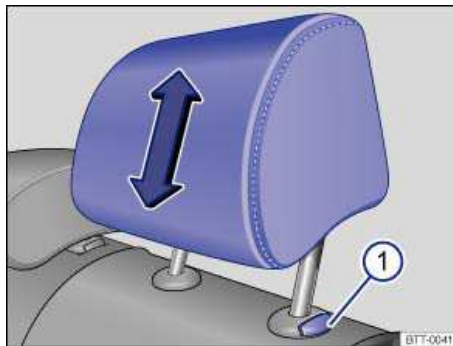

Fig. 46 Adjusting the rear head restraints.

**ⓘ Please first read and note the introductory information and heed the WARNINGS ⚠**

All seats are equipped with head restraints. The rear center head restraint is designed only for the center seat on the rear bench. Therefore, only install the center head restraint in the center position.

There are notches in the head restraint guide rods so that the head restraint can lock into place. Only properly installed head restraints can lock into place at the adjustment range notches. In order to prevent inadvertent removal of the head restraints after installation, there are stops at the top and bottom of the adjustment range.

**Adjusting the height**

- Push the head restraint up in the direction of the arrow or down when the button → [fig. 45 \(1\)](#) or → [fig. 46 \(1\)](#) is pressed ⇒ ⚠.
- The head restraint must lock securely in the position selected.

**Proper head restraint adjustment**

Adjust head restraints so that the upper edge of the head restraint is at least at eye level or higher. Position the back of the head as close as possible to the head restraint.

**Adjusting the head restraint for short people**

Push the head restraint down as far as it will go, even if this means the person's head is still below the top edge of the head restraint. A small gap may remain between the head restraint and the backrest when the head restraint is all the way down.

**Adjusting the head restraint for tall people**

Pull the head restraint up as far as it will go.



**WARNING**

**Driving without head restraints or with improperly adjusted head restraints increases the risk of serious injuries in a collision.**

- **Always drive with the head restraints in place and properly adjusted to help minimize the risk of neck injury in a crash.**
- **Every person in the vehicle must have a properly adjusted head restraint to minimize the risk of neck injury in a crash. Each head restraint must be adjusted according to the occupants' size so that the upper edge is even with the top of the person's head, but no lower than eye level. Always sit so that the back of your head is as close as possible to the head restraint.**
- **Never adjust head restraint while driving.**

## Removing and reinstalling head restraints

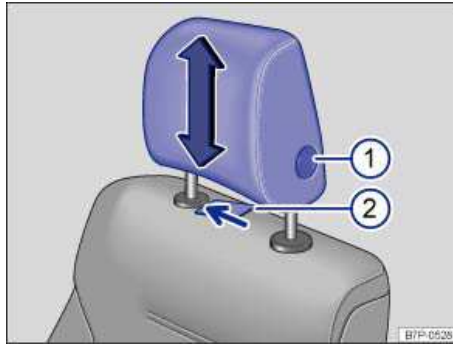

Fig. 47 Removing the front head restraints.

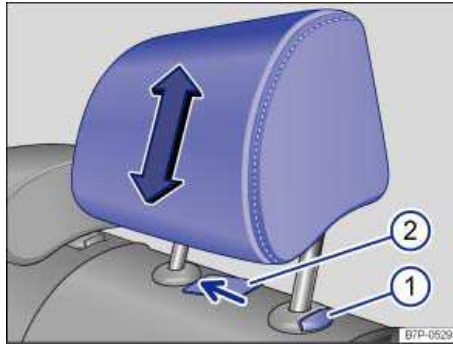

Fig. 48 Removing the rear head restraints.

**⚠ Please first read and note the introductory information and heed the WARNINGS ⚠**

All seats are equipped with head restraints. The rear center head restraint is designed only for the center seat on the rear bench. Therefore, only install the center head restraint in the center position.

### Removing the front head restraints

- Sit in the back seat behind the head restraint you want to remove. Pull the head restraint all the way up ⇒ ⚠ in *Adjusting front and rear head restraints* on page 86. Recline the backrest with the head restraint so that there is enough overhead clearance to remove it.
- Slide a flat object, such as a plastic credit card, underneath the right side of the cap on the right-hand seat guide rod ⇒ [fig. 47 \(2\)](#) to unlock the head restraint.
- Push the flat object (plastic card) in against the guide rod to depress a release button located under the cap (not visible).
- Use one hand to hold the release button in with the flat object. With your other hand, lift the same guide rod slightly to expose a notch in the rod at the bottom (can be seen and felt with fingers). The right-hand guide rod is now released.
- To release the left-hand guide rod, press button (1) in (towards guide rod) and hold.
- Pull the head restraint out completely while holding button (1).



### Installing the front head restraints

- Position head restraint properly over the head restraint guides of the respective seat backrest and insert the head restraint into the guides until it clicks.
- Guide the rods of the head restraint into the corresponding guides on the backrest.
- Push the head restraint down while pressing button (1).
- Adjust the head restraint according to the occupant's size ⇒ *Adjusting front and rear head restraints*.

### Removing the rear head restraints

- Unlock the rear bench and fold forward ⇒ *Luggage compartment*.
- Pull the head restraint all the way up ⇒  in *Adjusting front and rear head restraints* on page 86.
- Slide a flat object, such as a plastic credit card, underneath the right side of the cap on the right-hand seat guide rod ⇒ [fig. 48 \(2\)](#) to unlock the head restraint.
- At the same time press button (1) while a second person pulls out the head restraint completely.
- Fold the backrest of the rear seat bench back so that it locks securely.

### Installing the rear head restraints

- Unlock the backrest of the rear seat bench and fold it forward ⇒ *Luggage compartment*.
- Position head restraint properly over the head restraint guides of the respective seat backrest and insert the head restraint into the guides.
- Push the head restraint down while pressing the button (1).
- Fold the backrest of the rear bench back so that it locks securely.
- Adjust the head restraint according to the occupant's size ⇒ *Adjusting front and rear head restraints*.



#### WARNING

Driving without head restraints or with improperly adjusted head restraints increases the risk of serious injuries in a collision.

- Always drive with the head restraints in place and properly adjusted to help minimize the risk of neck injury in crash.
- Always reinstall head restraints as soon as possible so that vehicle occupants are properly protected.



#### NOTICE

When removing or reinstalling the head restraint, take care that the head restraint does not strike the headliner or the back of the front seat. The headliner or other parts of the vehicle could otherwise be damaged.

## Adjusting the steering wheel position

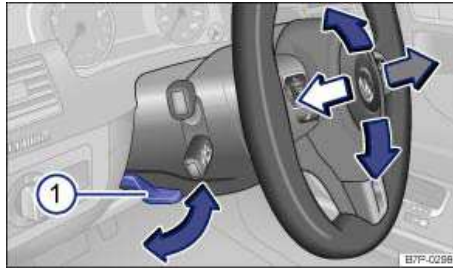

Fig. 49 Manual adjustment for the steering wheel position.

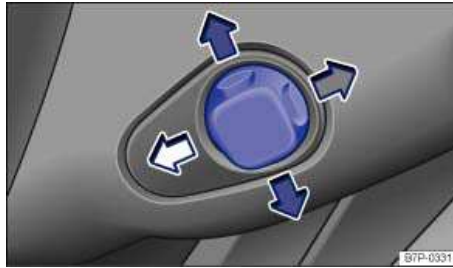

Fig. 50 Behind the steering wheel on the steering column: electrical adjustment for steering wheel.

**⚠ Please first read and note the introductory information and heed the WARNINGS ⚠**

Adjust the steering wheel only when the vehicle is not moving.

Adjust the steering wheel so that it can be held with hands at the 9 o'clock and 3 o'clock positions on the outside of the steering wheel rim and with the arms slightly bent at the elbow.

### Manual adjustment

- Push down on the lever ⇒ fig. 49 (1).
- Position the steering wheel as desired.
- Pull the lever up firmly until it is flush with the steering column ⇒ ⚠.

### Electrical adjustment

The switch ⇒ fig. 50 for electrical adjustment is on the left side of the steering column.

- Push the switch in the direction you want the steering wheel to move until it is in the desired position.

### Convenience entry function

The steering column automatically moves to the top front position when the key is removed from the ignition.

When the ignition is switched off using the Keyless Access when the driver door is opened, the steering column automatically moves to the top front position.

When the ignition is switched on and the driver door is closed, the steering column automatically moves back into the last stored position assigned to the key in use ⇒ ⚠.

**⚠ WARNING**

Improper use of the steering column adjustment feature can result in serious personal injury and even death.

- Always pull the lever ⇒ [fig. 49 \(1\)](#) firmly upward after adjusting the steering column so that the steering wheel does not change position suddenly while the vehicle is moving.
- Never adjust the steering column while the vehicle is moving. If you find that you need to adjust the steering wheel while driving, stop the vehicle in a safe place and make the proper adjustment.
- Never adjust the steering wheel so that it points toward your face. Always make sure that the steering wheel points toward your chest. Otherwise, the airbag system cannot protect you properly in the event of a crash.
- Always hold the steering wheel on the outside of the steering wheel rim with your hands at the 9 o'clock and 3 o'clock positions to help reduce the risk of serious personal injury if the driver's airbag inflates.
- Never hold the steering wheel at the 12 o'clock position or with your hands anywhere inside the steering wheel or on the steering wheel hub. Holding the steering wheel the wrong way increases the risk of severe injury to the arms, hands, and head if the driver front airbag deploys.

### Center armrest

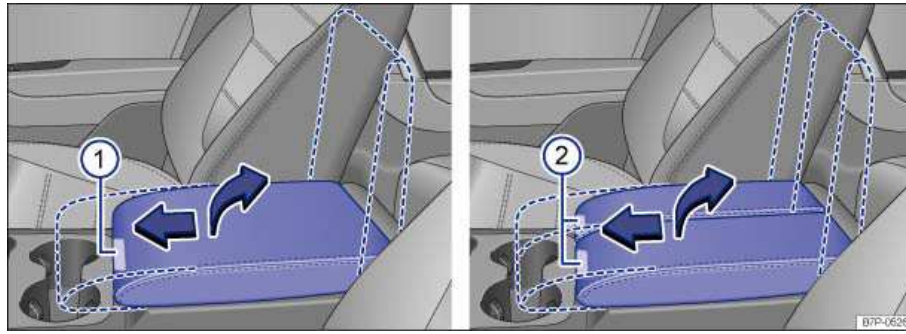

Fig. 51 Between the front seats: 1 part and 2 part front center armrest.

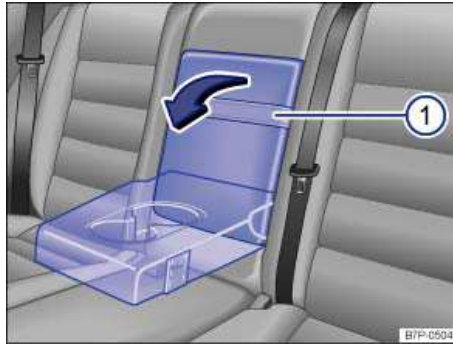

Fig. 52 Rear center armrest.

⚠ Please first read and note the introductory information and heed the WARNINGS ⚠

#### Front center armrest

There is a storage compartment under the front center armrest ⇒ *Storage compartment in the front center armrest.*

To *slide* (if applicable), press ⇒ fig. 51 (1) or (2) move the center armrest in the direction of the arrow ⇒ fig. 51.

To *open*, press button (1) or (2) and lift the center armrest section up completely in the direction of the arrow ⇒ fig. 51.

To *close*, push the center armrest down until it latches in place.

#### Rear center armrest

There may be a fold-down armrest with a small storage compartment in the backrest of the center rear seat ⇒ fig. 52.

To *fold down*, pull the loop in the direction of the arrow (1).

To *fold up*, push the center armrest up as far as it will go.

### ⚠ WARNING

The center armrest can restrict the driver's arm movement and cause crashes and serious personal injury.

- Always keep storage compartments in the center armrest closed while driving.
- Never let a passenger, especially a child, ride on the center armrest. Improper seating position can increase the risk of serious personal injury in a crash.
- Never put hot drinks or other liquids in the cup holder. Hot liquids can spill when the vehicle is moving as well as during braking or other sudden maneuvers.

## Seat functions

### Introduction

---

In this section you'll find information about:

Seat heating

Memory seats

Assigning memory seat settings to the remote control vehicle keys

#### More information:

- Adjusting the seating position
- Safety belts
- Airbag system
- Child safety and child restraints
- Outside mirrors
- Infotainment System

#### WARNING

Improper use of seat adjustment controls can cause severe personal injuries.

- Always sit properly at all times before starting to drive and while the vehicle is moving. Make sure all passengers, especially children, are properly seated whenever the vehicle is moving.
- Keep hands, fingers, feet and other body parts away from moving parts and adjustment areas of the seats.

### Seat heating

---

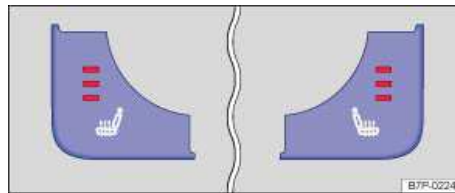

Fig. 53 In the upper front center console: Seat heating control for the front seats.

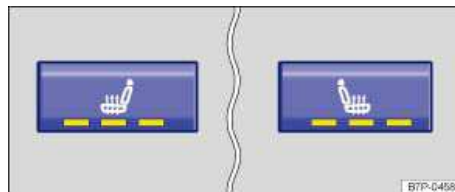







Fig. 54 In the rear center console: Seat heating control for the rear seats.

**ⓘ Please first read and note the introductory information and heed the WARNINGS ⚠**

When the ignition is switched on, the seat can be electrically heated by heating elements that warm the seat backrest and cushion.

Do not use the seat heating if any of the following conditions apply:

- If the seat is not being used.
- If there is a child restraint installed on the front passenger seat.
- If there is a blanket or seat cover on the front passenger seat.
- If the seat is damp or wet.
- If the outside temperature or the temperature inside the passenger compartment is +77 °F (+25 °C) or more.

Function	Action ⇒ <a href="#">fig. 53</a> or ⇒ <a href="#">fig. 54</a>
Switch on:	Press the  or  button. Seat heating is switched on to maximum. All indicator lights light up.
Adjusting heating level:	Press the  or  button repeatedly until the desired heating level is set.
Switch off:	Press the  or  button repeatedly until all indicator lights are off ⇒ <a href="#">fig. 54</a> .

**Special seat heating features**

On the driver side the seat heating will resume at the setting that was set when the ignition was switched off. However, this feature only works if the ignition is switched back on within 10 minutes.

People suffering from a low level of perceived pain or a lowered awareness of pain as from medication, paralysis, or chronic illness (e.g. diabetes) should NEVER use the seat heating feature ⇒ ⚠.!

The use of seat heating by persons with these conditions could result in burns to the back, buttocks, and legs that may take a long time to heal and may never heal completely. If you have any of these conditions, you should take regular breaks and get out of the vehicle, particularly on long trips. Consult your doctor for advice regarding your specific condition.

## WARNING

Certain medical conditions, such as paralysis and diabetes, and certain medications can increase the risk of serious burns when the seat heating feature is switched on.

- Vehicle occupants who have a low level of perceived pain or a lowered awareness of pain can receive serious burns to the back, buttocks, and legs that take a long time to heal or may never heal completely.
- Never use the seat heating feature if you or your passengers are at risk of being burned because of a medical condition. Take regular breaks and get out of the vehicle, particularly on long trips. Consult your doctor for advice regarding your specific condition.
- Never let exposed skin remain in contact with the seat upholstery when the seat heating is being used.

## WARNING

- A wet seat can cause the seat heating to malfunction and increase the risk of serious burns.
- Always make sure the seats are dry before using the seat heating.
- Never sit on the seat with wet clothes.
- Never put damp or wet things including clothes on the seat.
- Never spill liquids on the seats.

## NOTICE

- To help prevent damage to electrical and other parts in the seat, do not kneel on the front seats or apply concentrated pressure to a small area of the seat or backrest.
- Liquids, sharp objects and things that do not let the heat in the seat escape into the air, including, for example, a child restraint, a blanket or seat covers on the seat can damage seat heating.
- If you smell an odor, immediately shut off seat heating and have it checked by an authorized Volkswagen dealer or authorized Volkswagen Service Facility.
- Never install leather upholstery on a vehicle with seat heating that originally had cloth upholstery. The seat heating elements for seats with cloth seats will overheat if the cloth upholstery is replaced with leather upholstery.



Switch off seat heating when it is not needed to help reduce unnecessary fuel consumption.

## Memory seats

---



Fig. 55 Memory buttons in the upper part of the driver and front passenger doors.

**ⓘ Please first read and note the introductory information and heed the WARNINGS ⚠**

Depending on vehicle equipment, the vehicle may be equipped with seat memory functions for the driver seat or for the driver and front passenger seats.

### Memory buttons

Personal settings for the front seats, steering wheel position (if electrically adjustable), and the outside mirrors can be assigned to the memory buttons in the front vehicle doors and to every remote control vehicle key.

Personal settings for the front passenger seat can be assigned to the memory buttons in the front passenger door.

Depending on the vehicle equipment level a vehicle can be equipped with driver seat or driver and front passenger seat with memory functions.

### Storing driver seat settings and forward driving settings for outside mirrors

Switch on the ignition.

- Shift the transmission to Park (**P**).
- Adjust the driver seat and outside mirrors.
- Adjust the steering wheel position.
- Press the **SET** button until the LED lights up ⇒ fig. 55 (arrow).
- Within about 10 seconds press the desired memory button **1**, **2** or **3** ⇒ fig. 55. The LED will extinguish and a chime signal will confirm the memory storage.

### Storing front passenger seat settings to the front passenger door memory buttons

- Switch on the ignition.
- Sit on the front passenger seat and adjust it to the desired position.
- Press the **SET** button until the LED lights up (arrow).
- Within about 10 seconds press the desired memory button **1**, **2** or **3** ⇒ fig. 55. The LED will go out and a chime sounds to confirm that settings have been stored.

### Storing the passenger side outside mirror setting for backing up

- Apply the electronic parking brake.
- Switch on the ignition.
- Shift the transmission into Neutral (**N**).
- *Briefly* press the desired memory button **1**, **2** or **3** on the driver door.
- Shift the transmission into Reverse (**R**).
- Adjust the passenger outside mirror, to provide good visibility of the curb for example.
- The mirror position you have set is automatically stored and assigned to the selected memory button.

The passenger-side outside mirror automatically adjusts back from the position stored for backing up when the vehicle moves forward at about 10 mph (15 km/h) or more or when the rotary knob is rotated from (**R**) into a different position.

### Recalling stored memory settings

- With the vehicle door open and the *ignition off*, the stored setting positions can be recalled and set automatically. For this, tap the corresponding memory button **1**, **2** or **3** in the respective vehicle door *briefly*. After about 10 minutes, the stored positions can *not* be set automatically.
- **OR:** With the vehicle door *closed* press and hold the corresponding memory button on the vehicle door until the stored positions are reached.





### Assigning driver seat and outside mirror settings to a vehicle key

The memory function of all vehicle keys is disabled when the vehicle is first delivered from the factory.

To enable vehicle key memory function:

- Unlock the driver door.
- Press and hold a memory button ⇒ [fig. 55](#) until memory position is reached.
- Press and hold the unlock button  on the vehicle key and then press the desired memory button at the same time within about 3 seconds. A chime sounds to confirm activation.

To disable vehicle key memory function:

- Press and hold the  button.
- Press and hold the unlock button  on the vehicle key and the desired memory button at the same time within about 10 seconds. A chime sounds to confirm deactivation.

### Assigning settings to an additional vehicle key

- Follow the instructions ⇒ *Assigning memory seat settings to the remote control vehicle keys* to assign the driver seat and outside mirror settings to the vehicle key.
- Unlock the vehicle with the same vehicle key.
- Adjust driver seat and outside mirrors.
- Lock the vehicle with locking button  in the vehicle key to store the settings.

Once the settings are stored, the driver seat and the outside mirrors move to the stored positions whenever the vehicle is unlocked with the  button on the vehicle key (or unlocked with the door handle sensor on vehicles with Keyless Access) and the driver door is opened. If 2 people use the vehicle, each of them should always use the key in which his or her personal settings have been stored.

### Initializing the memory seats



The memory system must be initialized by an authorized Volkswagen dealer, an authorized Volkswagen Service Facility, or another qualified workshop in certain situations, for instance, if a new driver seat is installed.

Initializing clears all memories and assignments of the memory seats. After that, memory buttons can be reprogrammed and assigned to a vehicle key.

- Open the driver door but do not enter the vehicle.
- Adjust the seats from the outside.
- Move the angle of the backrest forward as far as it will go.
- Release the backrest adjustment switch and press it again until you hear a chime sound.

### Cancellation conditions when storing settings for the memory buttons

When one of the following conditions is met, the storing process will be cancelled:

- Charging condition of the vehicle battery is weak.
- Repeated pressing of the  button within about 10 seconds.
- Readjustment of the seat position within about 10 seconds after pressing the  button.

## Assigning memory seat settings to the remote control vehicle keys



Fig. 56 Infotainment system: Menu seat settings for the driver seat with memory feature.

### Please first read and note the introductory information and heed the WARNINGS

When enabled, every time you exit and lock the vehicle, your remote control vehicle key will remember the current seat position, steering wheel position (when electrically adjustable), and the outside mirrors settings. These settings will be stored and assigned to the *active* remote control vehicle key. The new stored settings will be automatically set after the vehicle is unlocked and the driver door is opened. When 2 or more people use the vehicle, it is recommended that every person use their “own” remote control vehicle key.

The condition for the automatic storage on the personal remote control vehicle key is that the same remote control vehicle key that triggered the unlocking of the vehicle is also used for locking.

### Activating the Key Fob Recall feature over the Infotainment system:

- Switch on the ignition.
- Press the **CAR** Infotainment button.
- Tap the **Settings** function key on the screen.
- Select **Seat settings** from the selection list.
- Check the check box by the **Driver seat remote control key** function key ⇒ fig. 56.
- The settings are stored when the vehicle is locked with the remote control vehicle key.

If automatic storage has already been activated on the driver door memory buttons, a check will be automatically set in the check box .

This feature works differently than your memory seat buttons.

Your memory seat positions can always be recalled using the buttons on the door.

If you prefer to not have it do this, just enter your “seat settings” again, and unmark the “Driver seat remote – control key” box.

 If the stored position settings have not been completed, there will not be *any* changed positions stored on the remote control vehicle key.

 If your seat moved to an odd position, DON'T WORRY! You must have simply grabbed the other remote control vehicle key than you normally do. Remember, if two drivers have this activated, then both keys might remember different positions.

# Safety belts

## Introduction

---

In this section you'll find information about:

Warning light  
Frontal collisions and laws of physics  
What happens to passengers not wearing a safety belt  
Safety belts protect  
Using safety belts  
Fastening and unfastening safety belts  
Safety belt position  
Safety belt height adjusters  
Safety belt extender  
Safety belt retractor, pretensioner, load limiter  
Service and disposal of belt pretensioners

Properly worn safety belts are the single most effective means of reducing the risk of serious injury and death in a collision or other accident.

Damage to safety belts reduces their overall effectiveness and increases the risk of serious personal injury and death whenever the vehicle is being used.

Check the condition of all safety belts regularly.

If a safety belt shows damage to webbing, bindings, retractors or buckles, have the safety belt replaced by an authorized Volkswagen dealer or an authorized Volkswagen Service Facility ⇒ .

### **More information:**

- Adjusting the seating position
- Airbag system
- Child safety and child restraints
- Parts, accessories, repairs and modifications

 **WARNING**

Not wearing a safety belt or wearing an improperly positioned safety belt increases the risk of severe personal injury or death. Safety belts offer optimum protection only when they are used properly.

- Properly worn safety belts are the single most effective means of reducing the risk of serious injury and death in a collision or other accident. For this reason, always wear your safety belt properly and make sure all passengers wear their safety belts properly as well whenever the vehicle is moving.
- The driver must always make sure that every person in the vehicle is properly seated on a seat of his or her own, properly fastens the safety belts belonging to that seat before the vehicle starts to move, and keeps the belts properly fastened while riding in the vehicle. This applies even when just driving around town. Therefore, always wear your safety belts and make sure that everybody in your vehicle is properly restrained.
- Always secure children in the vehicle with a restraint system appropriate for their age, weight and height
- Always fasten safety belts correctly before driving off and make sure that all passengers are properly restrained.
- Never attach the safety belt to the buckle of another seat. Attaching the safety belt to the wrong buckle will reduce safety belt effectiveness and can cause serious personal injury.
- Never let any objects or liquids get into the safety belt latch and prevent it from working properly.
- Never remove a safety belt while the vehicle is moving. Doing so will increase your risk of being injured or killed.
- Never strap more than one person, including small children, into any single safety belt.
- Never let children or babies ride sitting on your lap, and never place a safety belt over a child sitting on your lap.
- Never wear belts over rigid or breakable objects in or on your clothing, such as eye glasses, pens, keys, etc., as these may cause injury.
- Several layers of heavy clothing (such as a coat worn over top of a sports jacket) may interfere with proper positioning of the belt and reduce the overall effectiveness of the system.
- Never use comfort clips or devices that create slack in the shoulder belt. However, special clips may be required for the correct use of some child restraint systems.
- Safety belts offer optimum protection only when the seat backrest is upright and belts are correctly positioned on the body.

**⚠ WARNING**

Damage to safety belts reduces their overall effectiveness and increases the risk of serious personal injury and death whenever the vehicle is being used.

- Never let safety belts become damaged by being caught in the door or seat hardware.
- Torn or frayed safety belts can tear, and damaged safety belt hardware can break in an accident.
- Inspect belts regularly for damage. If webbing, bindings, buckles, or retractors are damaged, have the belts replaced immediately with the correct replacement belts approved by Volkswagen for your vehicle, model, and model year.
- Safety belts that were subject to stress in an accident and stretched must be replaced with a correct, new safety belt, preferably by an authorized Volkswagen dealer or an authorized Volkswagen Service Facility.
- Replacement after a crash may be necessary even if a safety belt shows no visible damage. Anchorages that have been loaded must also be inspected.
- Damaged safety belts must be replaced; they cannot be repaired.
- Never try to repair a damaged safety belt yourself. Never remove or modify the safety belts in any way.
- Have safety belts, bindings, retractors and buckles replaced by an authorized Volkswagen dealer or authorized Volkswagen Service Facility.
- Always keep the belts clean. Dirty belts may not work correctly and can impair the function of the inertia reel.

**Warning light**



Fig. 57 Warning light in the instrument cluster.

ⓘ Please first read and note the introductory information and heed the WARNINGS ⚠

Lights up or flashes	Possible cause	Proper response
	Driver and/or passenger safety belts not buckled.	Fasten safety belts.

Lights up or flashes	Possible cause	Proper response
	Heavy items on the front passenger seat.	Remove items from front passenger seat and stow them safely.

When the ignition is switched on, several warning and indicator lights come on briefly for a function check. They go out after a few seconds.

A warning chime also sounds.

The safety belt warning light  comes on for 6 seconds when the ignition is switched on. A warning chime also sounds for up to six seconds if the driver's safety belt is not buckled. The chime stops sooner if the driver buckles his or her safety belt. The warning light and the chime also go out when both driver and front passenger have buckled their safety belts.

If the driver and front seat passenger do not both fasten their safety belts within about 24 seconds after the chime stops and the vehicle is moving at a speed of more than about 15 mph (25 km/h), the chime will again sound for about 6 seconds, then go off for about 24 seconds, then sound again for about another 6 seconds. The same thing happens if one of the safety belts is first fastened and then unfastened while the vehicle is moving. The safety belt warning light also flashes . The warning chime continues to sound at 24 second intervals for up to 2 minutes. No chime sounds at speeds of less than about 5 mph (8 km/h).

If the ignition is switched on, the safety belt warning light  stays on until the driver and front passenger have both buckled their safety belts.

### WARNING

**Not wearing a safety belt or wearing an improperly positioned safety belt increases the risk of severe personal injury or death. Safety belts offer optimum protection only when used correctly.**

## Frontal collisions and laws of physics



Fig. 58 A vehicle with passengers not wearing safety belts approaches a wall.

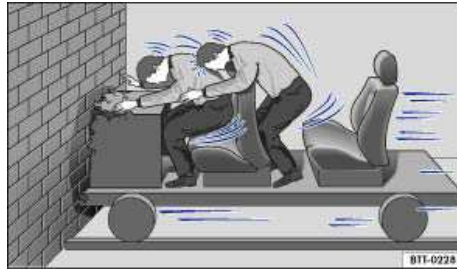

Fig. 59 A vehicle with passengers not wearing safety belts hits a wall.

**⚠ Please first read and note the introductory information and heed the WARNINGS ⚠**

The physical principles of a frontal collision are simple. Both the moving vehicle and the passenger possess energy ⇒ fig. 58, which varies with vehicle speed and body weight. Engineers call this energy “kinetic energy.”

The higher the speed of the vehicle and the greater the vehicle's weight, the more energy has to be “absorbed” in a crash.

Vehicle speed is the most significant factor. If your speed doubles (for example, from 15 mph to 30 mph - 25 km/h to 50 km/h), the energy increases 4 times!

Because the occupants of the vehicle in the above example are not using safety belts, they are not “attached” to the vehicle. In a frontal collision, they will keep moving at the same speed the vehicle was moving just before the crash, until something stops them - here, the inside of the passenger compartment. Because the occupants of the vehicle in the example are not wearing safety belts, their entire kinetic energy will be absorbed by impact with the wall ⇒ fig. 59.

The same principles apply to people in a vehicle that is in a frontal collision on the highway. Even at city speeds of 20–30 mph (30–50 km/h), the forces acting on the body can reach one ton (2,000 lbs or 1,000 kg) or more. At greater speeds, these forces are even higher.

Of course, the laws of physics don't apply just to frontal collisions; they determine what happens in all kinds of accidents and collisions.

## What happens to passengers not wearing a safety belt

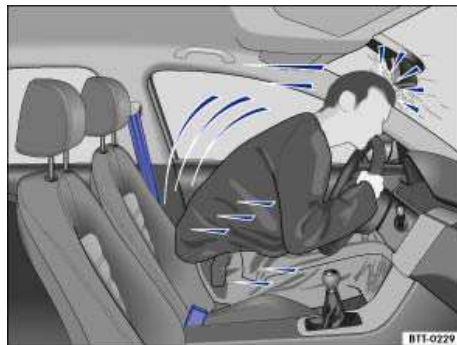

Fig. 60 The unbelted driver is thrown forward.



Fig. 61 Unbelted passengers in the rear seats are thrown forward on top of the belted driver.

⚠ Please first read and note the introductory information and heed the WARNINGS ⚠

Many people believe that it is possible to resist the forces of an impact by holding tight or bracing themselves. That is simply not true!

Even at low collision speeds, the forces acting on the body are too much for the body to be held in the seat with the arms and hands. In a frontal collision, unrestrained occupants will slam violently into the steering wheel, instrument panel, windshield or anything else in the way ⇒ fig. 60.

Never rely on airbags alone for protection. Even when they deploy, airbags provide only additional protection. Airbags are not supposed to deploy in all kinds of accidents. Even if your vehicle is equipped with airbags, all vehicle occupants, including the driver, must wear safety belts correctly in order to minimize the risk of severe injury or death in a crash, regardless of whether a seating position has an airbag or not.

An airbag will deploy only once. Safety belts are always there to offer protection in those accidents in which airbags are not supposed to deploy or when they have already deployed. Unbelted occupants can also be thrown out of the vehicle, causing even more severe injuries or death.

It is also important for occupants in the rear seats to wear their safety belts properly since they can be thrown violently forward through the vehicle in the event of an accident. Unbelted passengers in the rear seats endanger not only themselves but also the driver and other passengers in the vehicle

⇒ fig. 61.

## Safety belts protect

---



Fig. 62 Belted driver secured by the correctly worn safety belt in the event of a sudden braking maneuver.



**ⓘ Please first read and note the introductory information and heed the WARNINGS ⚠**

Used properly, safety belts can make a big difference. Safety belts help to keep passengers in their seats, gradually reduce energy levels applied to the body in a collision, and help prevent the uncontrolled movement that can cause serious injuries. In addition, safety belts reduce the danger of being thrown out of the vehicle ⇒ fig. 62.

Safety belts attach passengers to the car and give them the benefit of being slowed down more gently or “softly” through the “give” in the safety belts, crumple zones, and other safety features (such as airbags) engineered into today’s vehicles. The front crumple zones and other passive safety features (such as the airbag system) are also designed to absorb kinetic energy. By “absorbing” the kinetic energy over a longer period of time, the forces on the body become more “tolerable” and less likely to cause injury.

Although these examples are based on a frontal collision, safety belts can also substantially reduce the risk of injury in other kinds of crashes. So, whether you’re on a long trip or “just going to the corner store,” always buckle up and make sure that others do, too.

Accident statistics show that vehicle occupants properly wearing safety belts have a lower risk of being injured and a much better chance of surviving a collision. Properly using safety belts also greatly increases the ability of the supplemental airbags to do their job in a collision. For this reason, wearing a safety belt is required by law in most countries including the United States and Canada.

Although your Volkswagen is equipped with airbags, you still have to wear the safety belts provided. Front airbags, for example, are activated only in some frontal collisions. The front airbags are not activated in all frontal collisions, in side and rear collisions, in rollovers, or in cases when the conditions for deployment stored in the electronic control unit are not met. The same goes for the other airbag systems on your Volkswagen.

So always wear your safety belt and make sure that everybody in your vehicle is properly restrained!

---

## Using safety belts

---

**ⓘ Please first read and note the introductory information and heed the WARNINGS ⚠**

### Checklist

---

Using safety belts ⇒ ⚠

- ✓ Damage to safety belts reduces their overall effectiveness and increases the risk of serious personal injury and death whenever the vehicle is being used.
  - ✓ Check the condition of all safety belts regularly.
  - ✓ Keep safety belts clean.
  - ✓ Keep objects and liquids away from safety belt webbing, the safety belt buckle tongue, and the safety belt buckle latch and opening.
  - ✓ Do not pinch or damage the safety belt or buckle tongue (for instance, when closing a door).
  - ✓ Never modify, disassemble or try to repair safety belts and safety belt anchorages.
  - ✓ Always fasten your safety belt properly before driving and keep it fastened whenever the vehicle is moving.
- 

### Twisted safety belt

If it is difficult to pull the safety belt out of the belt guide, the belt may be twisted inside the side trim because the belt retracted too quickly when it was taken off.

- Hold the safety belt tongue, slowly and carefully pull safety belt all the way out.
- Untwist the safety belt and slowly return the belt by hand.

If you cannot untwist the safety belt, wear it anyway. Make sure that the safety belt is twisted in a spot where it does not come in direct contact with your body. Have the safety belt untwisted immediately by an authorized Volkswagen dealer or authorized Volkswagen Service Facility.

### Lockable safety belt

The retractors for the rear seat safety belts and the front passenger safety belt have a switchable locking feature for child restraints in addition to the emergency locking feature. Whenever a child restraint is installed with a safety belt, the safety belt must be locked so that the safety belt webbing cannot unreel. The switchable locking feature lets you lock the belt so that a child restraint can be properly installed and, for example, so that it can't tip to the side when the vehicle goes around a corner ⇒ page **Error! Bookmark not defined.**, *Child safety and child restraints*.

To see whether a safety belt is lockable, pull the safety belt *all the way* out of the safety belt retractor. You should then hear a "clicking" sound as the belt winds back into the retractor reel. Test the switchable locking feature by pulling on the belt. When the switchable locking feature is active, you should no longer be able to pull the belt out of the retractor.

The locking feature must be deactivated when a vehicle occupant uses the safety belt.

 <b>WARNING</b>	
<b>Improper use and care of safety belts increases the risk of severe personal injury or death.</b>	
<ul style="list-style-type: none"><li>• Regularly check safety belts and related parts for damage.</li><li>• Damaged safety belts must be replaced; they cannot be repaired.</li><li>• Always keep safety belts clean.</li><li>• Never catch, damage or chafe safety belt webbing on sharp edges.</li><li>• Always keep objects and liquids away from the belt buckle and buckle opening.</li></ul>	

## Fastening and unfastening safety belts

---

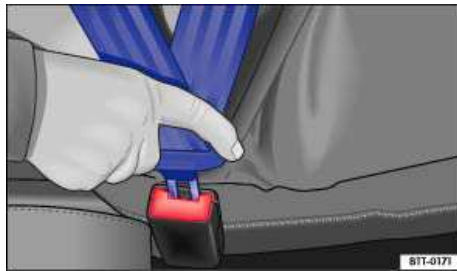

Fig. 63 Inserting the buckle tongue into the belt buckle.



**Fig. 64** Releasing the buckle tongue from the belt buckle.

**⚠ Please first read and note the introductory information and heed the WARNINGS ⚠**

Properly worn safety belts help to hold occupants in their seats and provide optimum protection during braking or in a collision or other accident ⇒ ⚠.

The switchable locking feature makes a “clicking” sound when the safety belt is winding back onto the safety belt retractor wheel after being pulled *all the way* out. Whenever a child restraint is installed with a safety belt, the safety belt must be locked so that the safety belt webbing cannot unreel ⇒ *Child safety and child restraints*. If active, deactivate the locking feature before using the safety belt to restrain a person without a child restraint system.

### Fastening safety belts

Always buckle your safety belt before driving.

- Adjust the front seat and head restraint correctly ⇒ *Adjusting the seating position*.
- Make sure the seat backrest of the rear seat bench is in an upright position and securely latched in place before using the safety belt ⇒ ⚠.
- Hold the safety belt by the tongue and pull it slowly and evenly across the chest and pelvis. Do **not** twist the safety belt webbing ⇒ ⚠.
- Insert the tongue into the correct buckle for your seat until you hear it latch securely ⇒ [fig. 63](#).
- Pull on the safety belt to make sure that it is securely latched in the buckle.

### Unfastening safety belts

Unfasten safety belts only when the vehicle is not moving ⇒ ⚠.

- Press the red button on the buckle ⇒ [fig. 64](#). The buckle tongue is ejected.
- Let the belt wind up on the retractor as you guide the belt tongue to its stowed position to help prevent the safety belt from twisting and to help avoid damage to the interior trim.

## **⚠ WARNING**

**Improperly positioned safety belts can cause serious personal injury or death in an accident.**

- **Safety belts offer optimum protection only when the seat backrest is upright and belts are correctly positioned on the body.**
- **A person who is not properly restrained can be seriously injured by the safety belt itself if it slips from the stronger parts of the body into sensitive areas like the abdomen.**
- **Unfastening safety belts while the vehicle is in motion can cause severe personal injury or death in the event of an accident or braking maneuver!**

## Safety belt position

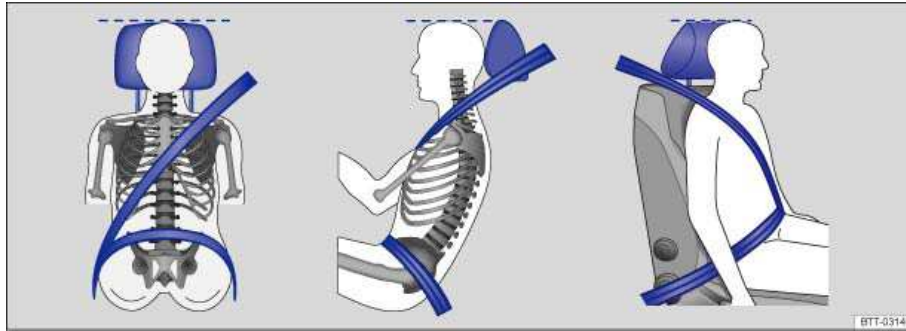

Fig. 65 Proper safety belt positioning and head restraint adjustment.



Fig. 66 Proper safety belt positioning for expectant mothers.

### **⚠ Please first read and note the introductory information and heed the WARNINGS ⚠**

Wearing safety belts improperly can cause serious injury or death. Safety belts can only work when they are correctly positioned on the body. A properly worn safety belt also helps to position the occupant so that an airbag can provide maximum protection when deployed. Therefore, always fasten your safety belt and make sure that it is properly positioned over your body.

Improper seating positions reduce the effectiveness of safety belts and even increase the risk of injury or death by moving the safety belt to critical areas of the body. Improper seating positions also increase the risk of severe injury or death when an airbag deploys and strikes an occupant who is not seated properly ⇒ *Adjusting the seating position.*

### **Proper safety belt position**

- The shoulder portion of the safety belt must always run over the center of the shoulder and never over the throat, over the arm, under the arm or behind the back ⇒ [fig. 65](#).
- The lap portion of the safety belt must always run as low as possible over the pelvis and never over the abdomen.
- Always wear the safety belt flat and snug against the body. Pull on the safety belt to tighten if necessary.

**Expectant mothers** must always wear the lap portion of the safety belt as low as possible across the pelvis and below the rounding of the abdomen – throughout the pregnancy. The safety belt must lie flat against the body to avoid pressure against the abdomen → [fig. 66](#).

#### **Adjusting safety belt height**

The safety belt position can be adjusted using the following features:

- Safety belt height adjusters for the front seats.
- Front seats with height adjustment.

 <b>WARNING</b>	
<b>Improperly positioned safety belts can cause serious personal injury in an accident or a sudden braking maneuver.</b>	
<ul style="list-style-type: none"><li>• <b>Always make sure that all vehicle occupants are correctly restrained and stay in a correct seating position whenever the vehicle is being used.</b></li><li>• <b>Safety belts offer optimum protection only when the seat backrest is upright and belts are correctly positioned on the body.</b></li><li>• <b>A loose fitting safety belt can cause serious injuries by shifting its position on your body from the strong bones to more vulnerable soft tissue and cause serious injury.</b></li><li>• <b>The shoulder belt portion of the safety belt must be positioned over the middle of the occupant's shoulder and never across the neck or throat.</b></li><li>• <b>The safety belt must lie flat and snug on the occupant's upper body.</b></li><li>• <b>Never wear the shoulder part of the safety belt under your arm or otherwise out of position.</b></li><li>• <b>The lap portion of the safety belt must be positioned as low as possible across the pelvis and never over the abdomen. Make sure the belt lies flat and snug against the pelvis. Pull on the safety belt to tighten if necessary.</b></li><li>• <b>Expectant mothers must always wear the lap portion of the safety belt as low as possible across the pelvis and below the rounding of the abdomen.</b></li><li>• <b>Do not twist the belt when attaching it. If you cannot untwist a twisted safety belt, wear it anyway, but make sure the twisted part is not in contact with your body. Have the problem corrected right away by an authorized Volkswagen dealer or authorized Volkswagen Service Facility.</b></li><li>• <b>Never hold the safety belt away from your body with your hand.</b></li><li>• <b>Never wear belts over rigid or breakable objects, such as eye glasses, pens or keys.</b></li><li>• <b>Never modify the position of the belt using comfort clips, loops or similar devices.</b></li></ul>	

 If you have a physical impairment or condition that prevents you from sitting properly on the seat with the safety belt properly fastened, special modifications to your vehicle may be necessary.

- Contact your authorized Volkswagen dealer or authorized Volkswagen Service Facility or call the Volkswagen Customer CARE Center at 1-800-822-8987 for information about possible modifications to your vehicle.

## Safety belt height adjusters

---

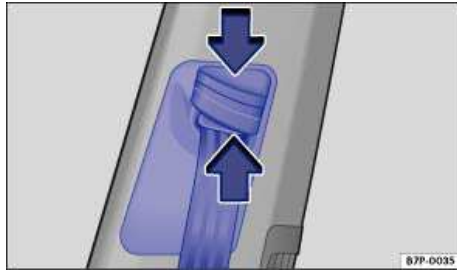

Fig. 67 Next to the front seats: Manual safety belt height adjuster.

**⚠ Please first read and note the introductory information and heed the WARNINGS ⚠**

Safety belt height adjusters for the front seats can be used to adjust the height of the shoulder portion of the safety belt so that it is positioned correctly:

- Press and hold the safety belt attachment ⇒ [fig. 67](#).
- Pinch the safety belt attachment together as indicated by the arrows and slide the seat belt attachment to the desired position ⇒ [fig. 67](#).
- Slide the belt and upper attachment up or down until the safety belt is positioned over the center of the shoulder
- Release the safety belt attachment.
- Pull on the safety belt to make sure that the upper attachment is securely locked in place.

### **⚠ WARNING**

**Never adjust the height of the safety belt while driving.**

## Safety belt extender

---

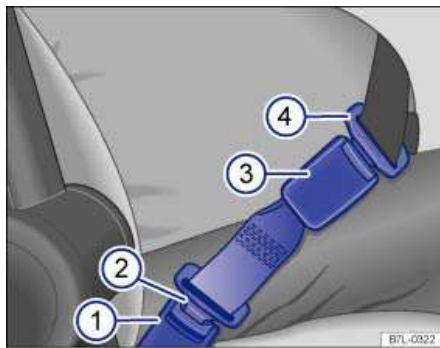
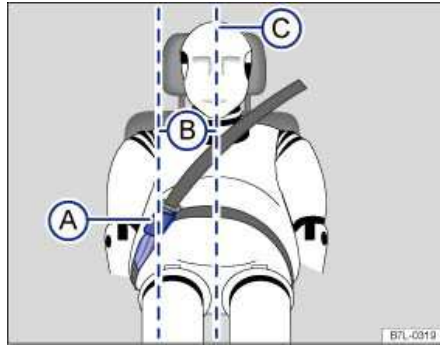

Fig. 68 A safety belt extender properly attached to the factory-installed safety belt.



**Fig. 69** Positioning of the safety belt extender.

**⚠ Please first read and note the introductory information and heed the WARNINGS ⚠**

If a safety belt is too short to correctly fit you or one of your passengers, even when the safety belt is pulled out all the way, you can use a safety belt extender.

Never use the safety belt extender for any other purpose – including the attachment of a child restraint.

The extender adds about 8 inches (20 cm) to the safety belt. Always remove the safety belt extender when it is not needed and stow it safely. Contact an authorized Volkswagen dealer or authorized Volkswagen Service Facility if you believe you may need an extender.

**Key to fig. 68:**

- (1) Vehicle safety belt buckle.
- (2) Buckle tongue on the safety belt extender.
- (3) Safety belt buckle on the safety belt extender.
- (4) Safety belt buckle tongue on the factory-installed safety belt.

**Key to fig. 69:**

- (A) Safety belt buckle on the safety belt extender.
- (B) Distance between the safety belt buckle on the safety belt extender and the centerline of the person using the safety belt extender. **The distance must be more than 6 inches (15 cm)!**
- (C) Centerline of the person using the safety belt extender.

**Using a safety belt extender**

- Adjust both the seat and the head restraint properly ⇒ page 77, *Adjusting the seating position*.
- Insert the buckle tongue on the safety belt extender ⇒ fig. 68 (2) into the vehicle belt buckle for the seat where the safety belt extender is being used (1).
- Fastening or unfastening the vehicle safety belt ⇒ *Fastening and unfastening safety belts*.
- Pull the belt to make sure that the tongues are securely locked in the buckles.
- Make sure that the safety belt is positioned properly ⇒ *Safety belt position*.

**Properly using safety belt extenders:**

- Use a safety belt extender only when the factory installed safety belt is too short when worn properly by a person in proper seating position.
- Only use 1 safety belt extender per seat and vehicle safety belt.
- Always remove the safety belt extender when it is not needed.
- Never leave a safety belt extender attached to the vehicle safety belt buckle when the extender is not needed and being used with the safety belt. Otherwise, the airbag control module will receive an incorrect signal from the safety belt buckle and this will prevent the airbag from working properly for a

person who is not using the safety belt. Leaving the extender attached to the safety belt buckle when the front seat is occupied and the safety belt is not being used will signal the airbag control unit during a collision that the front passenger seat is occupied and that the safety belt is being used. The electronic control unit for the airbag system will then receive incorrect information that will cause the safety belt pretensioner to deploy unnecessarily and the front passenger airbag to deploy later in collisions that would normally trigger the front airbag earlier in the collision to help protect an unrestrained front seat occupant. The airbag will not be able to provide enough protection for an occupant not wearing a safety belt.

- Only use the safety belt extender approved by Volkswagen for your vehicle.

## **WARNING**

**Improper use or positioning of a safety belt extender increases the risk of serious personal injury and death.**

- A driver or passenger who is not properly restrained can be seriously injured by striking the interior of the passenger compartment or by the safety belt itself, which can be displaced from stronger parts of the body into sensitive areas like the abdomen.
- Safety belt extenders offer optimum protection only when they are properly used.
- Only use the extender when the belt is not long enough to be worn low and snug and the person is in the correct seating position. Remove and stow extender safely when not needed.
- Always make sure the safety belt tongue of the safety belt extender is securely inserted into the buckle for the seating position that belongs to the seat where the safety belt extender is being used. Attaching the safety belt to the wrong buckle will reduce safety belt effectiveness and can cause serious personal injury.
- Never use the safety belt extender if you can properly attach the safety belt without it. Using a safety belt extender when not needed can increase the risk of injury, especially in a collision.
- Never use a safety belt extender if the distance (B) between the front edge of the safety belt extender buckle (A) and the centerline of the person using the safety belt extender ⇒ [fig. 69 \(C\)](#) is less than 6 inches (15 cm).
- Never leave a safety belt extender attached to the vehicle safety belt buckle when the extender is not needed and being used with the safety belt. Otherwise, the airbag control module will receive an incorrect signal from the safety belt buckle and this will prevent the airbag from working properly for a person who is not using the safety belt.
- Never use more than 1 extender with a safety belt. Using more than 1 extender can change the way the safety belt passes over the body and can cause serious injury.
- Never use the safety belt extender to secure a child restraint.
- Never use a safety belt extender on your Volkswagen that you got from another automobile manufacturer or from an automotive parts store.
- Never use the safety belt extender you got for your vehicle for any other vehicle, regardless of make, model, or model year.

## **NOTICE**

- Leaving the extender attached to the safety belt buckle when the front seat is occupied and the safety belt is not being used will signal to the airbag control unit that the front passenger seat is occupied and that the safety belt is being used. The electronic control unit for the airbag system will then receive incorrect information that will
  - cause the safety belt pretensioner to deploy unnecessarily in collisions.
  - cause the front passenger airbag to deploy later in collisions in which the front airbag would otherwise be triggered earlier to help protect an unrestrained front seat passenger.



- A pretensioner that has deployed cannot be repaired. The entire safety belt must be replaced.

## NOTICE

If the safety belt extender is left attached to the safety belt buckle, the safety belt warning system will sense that the safety belt for that seat is being used. The warning light will not come on and the warning chime will not sound even though the seat is occupied and the safety belt is not being used.

## Safety belt retractor, pretensioner, load limiter

---

 Please first read and note the introductory information and heed the WARNINGS 

The safety belts in the vehicle are part of the vehicle's safety concept ⇒ *Safety equipment* and consist of the following important features:

### Automatic safety belt retractors

Every safety belt is equipped with an automatic belt retractor on the shoulder belt. As long as the safety belt is pulled out slowly, the shoulder belt will extend to let you move freely under normal driving conditions. The automatic safety belt retractor locks the belt when the belt is pulled out fast, during hard braking and in a collision. The belt may also lock when you drive up or down a steep hill or through a sharp curve.

### Safety belt pretensioner

The safety belts on the front seats and the rear outboard seats have a pretensioner that helps take the slack out of the safety belt and tighten it when the pretensioner is activated.

The pretensioners are activated by the electronic control unit for the airbag system in front, side, and rear collisions. By tightening the safety belt, the pretensioner helps to reduce the occupant's forward movement. The belt pretensioner works together with the airbag system; its function is monitored by the airbag system indicator light. The belt pretensioner will not deploy in a rollover if the side airbags are not activated.

A fine dust may be released upon activation. This is normal and is not caused by a fire in the vehicle.

### Safety belt load limiter

All safety belts for outboard seating positions also have load limiters to help reduce the forces applied to the human body in a crash.

 Heed all safety regulations if the vehicle or individual components of the system have to be scrapped. Your authorized Volkswagen dealer and authorized Volkswagen Service Facility are familiar with these regulations ⇒ *Service and disposal of belt pretensioners*.

## Service and disposal of belt pretensioners

---

 Please first read and note the introductory information and heed the WARNINGS 

The pretensioners are part of the safety belts installed at the front seats in your vehicle. Installing, removing, servicing, or repairing of safety belt pretensioners can damage the safety belt system and prevent it from working correctly in a collision. The pretensioners themselves may then also not work in the event of an accident, or not work properly.

There are some important things you have to know to make sure that the effectiveness of the system will not be impaired and that discarded components do not cause injury or pollute the environment. Undeployed safety belt pretensioners and airbag modules contain explosive materials that can cause serious injuries to the general public and to people who work at dealerships and workshops, scrap yards, and recycling facilities. For this reason, the systems must be properly handled when they or the vehicles they are installed in are scrapped.

Undeployed safety belt pretensioners and airbag modules can also pollute the environment. Never abandon vehicles or vehicle parts. If your vehicle must be scrapped, please make sure that it is done safely, responsibly, and in compliance with all applicable environmental regulations. Take it to a licensed facility that has the knowledge and experience to properly dispose of the vehicle and its safety belt system. Your authorized Volkswagen dealer and authorized Volkswagen Service Facility are familiar with these regulations.

 **WARNING**

**Improper handling, care, servicing, and repair procedures can increase the risk of personal injury and death by preventing a belt pretensioner from activating when needed or by causing it to activate unexpectedly.**

- The pretensioner can be activated only once. If a pretensioner has been activated, the safety belt must be replaced.
- Safety belt systems including the pretensioners cannot be repaired. Special procedures are required to remove, install, and dispose of this system.
- Never repair, adjust, or change pretensioners or any other part of the safety belt system yourself. We strongly recommend that you have any work on the safety belt system performed by an authorized Volkswagen dealer or authorized Volkswagen Service Facility. They have the necessary technical information, training, and special equipment ⇒ *Parts, accessories, repairs and modifications.*

 **WARNING**

**Undeployed safety belt pretensioners and airbag modules contain explosive materials that can cause serious personal injuries if they are not properly handled when they or the vehicles they are installed in are scrapped.**

- Never abandon vehicles or vehicle parts.
- Always scrap vehicles and vehicle parts, especially those containing undeployed airbag modules and undeployed safety belt pretensioners, at a licensed facility that has the knowledge and experience to properly dispose of the vehicle and its safety belt and airbag systems.



Undeployed airbag modules and safety belt pretensioners are classified as **Perchlorate Material**. Special handling may apply – See <http://www.dtsc.ca.gov/hazardouswaste/perchlorate>. Obey all applicable legal requirements regarding handling and disposal of the vehicle or parts of its restraint system, including airbag modules and safety belts with pretensioners. Authorized Volkswagen dealers and authorized Volkswagen Service Facilities are familiar with the requirements, and we recommend that you have them perform this service for you.

# Lights

## Introduction

---

In this section you'll find information about:

Indicator lights

Turn signal lever and high beam switch

Switching lights on and off

Lights and vision features

Lights and vision features

“Coming home” and “Leaving home” feature (orientation lighting)

Instrument panel lighting and headlight range adjustment

Interior and reading lights

Always obey local vehicle lighting laws.

The driver is always responsible for the correct headlight settings and driving light.

### More information:

- Exterior views
- Volkswagen Information System
- Infotainment System
- Replacing light bulbs

 **WARNING**

**Headlights that are aimed too high and improper use of the headlight flasher or high beams can blind and distract other drivers. This can lead to a crash and serious personal injuries.**









- Always make sure that headlights are properly adjusted.
- Never use the headlight flasher or high beams when they can blind or distract other drivers.

## Indicator lights

---

 Please first read and note the introductory information and heed the WARNINGS 

Lights up	Possible cause	Proper response
	One or more driving lights not working or cornering light malfunction.	Replace burned out bulb or if all light bulbs are OK, visit an authorized Volkswagen dealer or authorized Volkswagen Service Facility.

	One or more brake lights burned out.	See an authorized Volkswagen dealer or an authorized Volkswagen Service Facility.
	Adaptive Front Lighting System (AFS) malfunction.	See an authorized Volkswagen dealer or an authorized Volkswagen Service Facility
	Headlight range adjustment malfunction.	See an authorized Volkswagen dealer or an authorized Volkswagen Service Facility
	Parking lights switched on.	
	One or more license plate lights burned out.	See an authorized Volkswagen dealer or an authorized Volkswagen Service Facility.
	Fog lights switched on.	
	Turn signals, left or right.	If necessary check the vehicle and trailer lighting.
	The indicator light blinks twice as fast if a turn signal is not working on the vehicle or the trailer.	
	Daytime running lights on.	
<b>DRL</b>		
	High beams switched on or headlight flashers in use.	

Flashes	Possible cause	Proper response
	Driving light system malfunction.	See an authorized Volkswagen dealer or an authorized Volkswagen Service Facility.

When the ignition is switched on, several warning and indicator lights come on briefly for a function check. They go out after a few seconds.

### **WARNING**

Failure to heed warning lights and instrument cluster text messages can cause the vehicle to break down in traffic and result in a collision and serious personal injury.

- Never ignore warning lights or text WARNINGS.
- Always stop the vehicle as soon as it is safe to do so.
- Whenever stalled or stopped for repair, move the vehicle a safe distance off the road, stop the engine, turn on the emergency flashers, and use other warning devices to warn approaching traffic.
- Never park the vehicle in areas where the hot catalytic converter and exhaust system can come into contact with dry grass, brush, spilled fuel, oil, or other material that can catch fire.
- A broken down vehicle presents a high accident risk for itself and others. Switch on emergency flashers and set up a warning triangle to warn oncoming traffic.

### **NOTICE**

Failure to heed warning lights or text WARNINGS can result in vehicle damage.

 High Intensity Discharge (HID) headlights provide bright, uniform lighting to help you see and be seen. The light comes from an electric arc between two electrodes in the gas-filled bulb. Over time, the electrodes can wear down and the gap between them will get wider. The HID lamp's control unit then increases the voltage to keep the arc's brightness constant. However, the commonly called "Xenon" bulbs will also ultimately burn out. Before they burn out, HID lamps can flicker. A message will then appear in the MFI. This is your reminder to see an authorized Volkswagen dealer or an authorized Volkswagen Service Facility to check the headlights.

## Turn signal lever and high beam switch

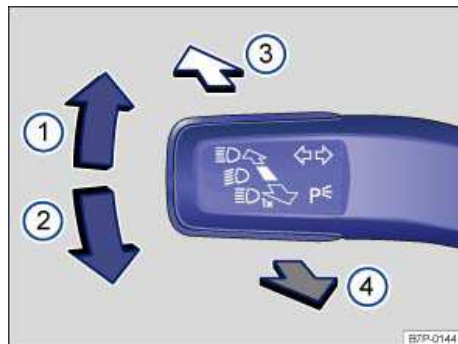





Fig. 84 Turn signal lever and high beam switch.

 Please first read and note the introductory information and heed the WARNINGS 

Move the lever to the desired position ⇒ fig. 84:

- (1) Right turn signal.

- (2) Left turn signal.
- (3) Switching high beams on ⇒ . The indicator light  comes on in the instrument cluster when the high beams are switched on.
- (4) Switching the high beams off and operating the headlight flasher. The *headlight flasher* turns on the high beams as long as the lever is pulled and manually held in the pulled position. The indicator light  lights up. When released, the lever moves back to the home position and turns off the high beams. The indicator light  goes out.

Move the lever back to the home position to turn the feature off.

#### Convenience turn signal (lane change feature)

To use the convenience turn signal feature, move the lever up or down slightly, just to the point of resistance and then release it. If you have the convenience turn signal (**Conv. turn sig.**) switched on, the turn signals and the turn signal indicator flash 3 times. If it is switched off, they flash as long as you hold the lever up or down, and go out when you release the lever.

The convenience turn signal is switched on and off in the **Lights & Vision** menu in the instrument cluster display ⇒ *Volkswagen Information System*. If your vehicle is not equipped with the **Lights & Vision** menu, the convenience turn signal feature can be deactivated by an authorized Volkswagen dealer or authorized Volkswagen Service Facility.

 **WARNING**

**Improper use of high beams can distract and blind others, causing accidents and serious injuries.**

 The turn signal light works only when the ignition is switched on. The emergency flasher works even when the ignition is switched off ⇒ *In an emergency*.

 The indicator light flashes twice as fast if a turn signal bulb is burned out.

 *High beams* can only be switched on when low beams are on.

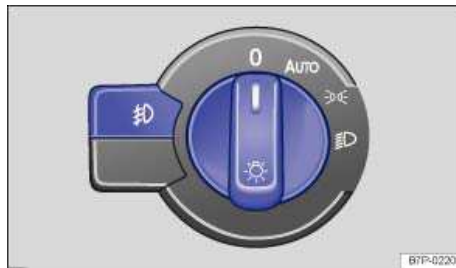

### Switching lights on and off



**Fig. 85** Next to the steering wheel: Headlight switch.



 Please first read and note the introductory information and heed the **WARNINGS** 

Turn the light switch to the desired position ⇒ [fig. 85](#):

	When the ignition is switched off	When the ignition is switched on
0	Fog lights, low beams and parking lights switched off.	Headlights off, daytime running lights (DRL) on.
AUTO	Orientation lighting may be switched on.	Automatic headlight control active; DRL.
	Parking lights switched on. Low beams off. Parking lights and DRL stay on.	Parking lights switched on.
	Low beams switched off – parking lights switched on.	Low beams switched on.
	Fog lights switched off. The DRL may stay on for some time.	Headlights and fog lights switched on.

**Fog lights:**

The indicator light  in the headlight switch or the instrument cluster shows that the fog lights are switched on.

- To switch on the fog lights : first turn the light switch to position , then pull the light switch out to the first detent.
- To switch off the fog lights, push the switch back in from the first detent. To then turn off the headlights, turn the switch to position 0.

**Acoustic warning when lights are not switched off**

In the following situations, a warning chime will sound if you take the key out of the ignition and open the driver door. This is to remind you that lights are still on.

- If the parking lights are switched on ⇒ *Switching lights on and off.*
- Light switch in position .

**⚠ WARNING**

Daytime running lights and parking lights are not bright enough to let you see ahead or be seen by others when it is dark.

- Always switch on the low beam headlights at dusk or when it is dark and whenever the weather is bad or visibility is poor.
- Never use the daytime running lights to see where you are going. They are not bright enough and will not let you see far enough ahead for safety, especially at dusk or when it is dark. Always switch on the low beam headlights at dusk or when it is dark.
- The taillights do not come on with the daytime running lights. Unless the taillights are on, a vehicle cannot be seen by others in bad weather, at dusk, or when it is dark.
- Even if automatic headlight control is switched on, the low beam headlights may still not come on by themselves in fog or heavy rain. You have to switch on the low beam headlights manually.

**i** In cool or humid weather, the insides of the headlights, the taillights, and turn signals can temporarily fog up. This is normal and does not affect the service life of the vehicle's lighting system.

**i** The length of time they stay on depends on the vehicle battery charge.

## Lights and vision features

**📖** Please first read and note the introductory information and heed the **WARNINGS** ⚠

### Daytime running lights (DRL)

Separate lamps are installed in the headlights or in the front bumper for the daytime running lights.

When the daytime running lights are on, only these separate lamps come on ⇒ ⚠.

The daytime running lights come on whenever the ignition is switched on and the light switch is in position **0** or **AUTO**. The  or **DRL** indicator light in the instrument cluster indicates that the feature is active ⇒ *Indicator lights*.

If the light switch is in position **AUTO**, a low light sensor switches the instrument and switch lighting on and off automatically.

### Daytime running lights (DRL) parking feature

Some models are equipped with a daytime running lights (DRL) parking feature that switches the daytime running lights off when the vehicle is parked and the ignition is switched on.

The daytime running lights can be activated and deactivated in the **Lights & Vision** menu in the instrument cluster display ⇒ *Volkswagen Information System*.

Function	Action
Switching the DRL off:	<ul style="list-style-type: none"><li>– Switch the ignition on.</li><li>– Turn the light switch to the <b>0</b> position.</li><li>– Set the parking brake.</li></ul>



Function	Action
Switching the DRL back on:	<ul style="list-style-type: none"> <li>– Release the parking brake.</li> <li>– <b>OR:</b> Turn the light switch to the  position.</li> </ul>

#### Static cornering lights

Your vehicle may have fog lights under the front bumper, which on some models are also static cornering lights. On some models the static cornering lights may be integrated in the headlights. At speeds below about 25 mph (40 km/h), the light on one side of the vehicle will come on when you turn a corner. If you turn to the right, the right fog light comes on; turn left and the left fog light comes on. The light dims and goes out when the steering wheel is straightened out again.

When you move the selector lever to Reverse (**R**), the static cornering lights on both sides of the vehicle may come on so that you can see the area around the vehicle better when backing up.

The static cornering lights work only when the headlights are on. If you are using automatic headlight control (headlight switch in the **AUTO** position) ⇒ [fig. 85](#), they work only when the headlights have been automatically switched on. The static cornering lights do not come on when the headlight switch is in the **0** position or when the fog lights themselves have been switched on ⇒ *Switching lights on and off*.

#### Automatic headlight control **AUTO**

Automatic headlight control is a convenience feature only and cannot always recognize all driving situations.

If the light switch is in the **AUTO** position, the outside vehicle lighting and the instrument lighting are automatically switched on at dusk/nightfall and off in normal daylight in the following situations ⇒ :

Automatic activation:	Automatic deactivation/change to daytime running lights:
If the low-light sensor registers <i>darkness</i> , for example when driving through a tunnel.	If sufficient brightness is registered.
If you drive faster than about 87 mph (140 km/h) for several seconds.	If you drive slower than about 40 mph (65 km/h) for several seconds.
If the rain sensor recognizes heavy rain and switches the windshield wipers on.	If the windshield wipers have not moved for several minutes.

## Adaptive Front Lighting System (AFS)

The Adaptive Front Lighting System works only with the low beams switched on and only at speeds about 6 mph (10 km/h). The swivel-mounted lamps automatically improve road illumination during cornering.

The Adaptive Front Lighting System can be switched on and off in the Infotainment System.

- Switch on the ignition.
- Press the **CAR** Infotainment button.
- Tap the **Settings** function key on the screen.
- Select the menu item **Lights and vision** from the list.
- Tap **Adaptive front lighting system (AFS)** to enable or disable this feature.

The feature is enabled when the check box in the **Adaptive front lighting system (AFS)** function key is checked .

## Lights with LED-technology

You cannot replace the LEDs. Contact your authorized Volkswagen dealer or an authorized Volkswagen Service Facility for assistance.

**⚠ WARNING**

**Crashes and other accidents can happen when you cannot see the road ahead and when you cannot be seen by other motorists.**

- **Never use daytime running lights (DRL) to see where you are going. (DRL) are not bright enough to light up the roadway and be seen by other motorists. You will not be able to see far enough ahead for safety, especially at dusk or when it is dark. Always switch on the low beam headlights at dusk or when it is dark.**
- **If automatic headlight control (AUTO) is switched on, the low beam headlights still may not be switched on in fog or heavy rain. You have to switch on the low beam headlights yourself.**
- **The taillights do not come on when the daytime running lights are switched on. A vehicle without taillights on cannot be seen by others in bad weather, at dusk, or when it is dark.**

**i** In cool or humid weather, the insides of the headlights, rear lights, and turn signals can temporarily fog up. This is normal and does not affect the service life of the vehicle's lighting system.

## [“Coming home” and “Leaving home” feature \(orientation lighting\)](#)

**ⓘ Please first read and note the introductory information and heed the WARNINGS ⚠**

The basic settings for the “Coming home” and “Leaving home” features must be made in the Infotainment System.

### Enabling and disabling the “Coming home” and “Leaving home” features

The “Coming home” and “Leaving home” features can be enabled or disabled in the Infotainment System.

- Switch on the ignition.
- Press the **CAR** Infotainment button.
- Tap the **Settings** features key on the screen.
- Select the menu item **Lights and vision** in the list.
- Tap **Coming home** or **Leaving home** to enable or disable the feature.

- Check the check box in the **Coming home** or **Leaving home** to select the  feature key.

#### **“Coming home” features**

The lighting delay period can be adjusted in the Infotainment System.

#### **Function key: More information**

---

---

**10 Sec.:** The lighting delay period is about 10 seconds. Tap the function to select the setting and close the window.

---

**20 Sec.:** The lighting delay period is about 20 seconds. Tap the function to select the setting and close the window.

---

**30 Sec.:** The lighting delay period is about 30 seconds. Tap the function to select the setting and close the window.

To close the window without changing the setting, tap .

#### **“Leaving home” feature**

The “Leaving home” feature can be enabled or disabled in the Infotainment System. The lighting delay period can also be adjusted in the Infotainment System.

#### **Function key: More information**

---

---

**Off:** Feature is switched off. Tap the function to select the setting and close the window.

---

**10 Sec.:** The lighting delay period is about 10 seconds. Tap the function to select the setting and close the window.

---

**20 Sec.:** The lighting delay period is about 20 seconds. Tap the function to select the setting and close the window.

---

**30 Sec.:** The lighting delay period is about 30 seconds. Tap the function to select the setting and close the window.

To close the window without changing the setting, tap .

#### **Switching the “Coming home” and “Leaving home” features on and off**

The “Coming home” feature must be switched on manually. The “Leaving home” feature is automatically controlled by a low-light sensor.

“Coming home”	Action
Switch on:	<ul style="list-style-type: none"> <li>– Switch off the ignition.</li> <li>– Operate the headlight flasher for about 1 second ⇒ page 117.</li> </ul> <p>Opening the driver door switches on the “Coming home” feature. The <i>delay period</i> starts when the last vehicle door or the rear hatch is closed. The “Coming home” lighting is switched on when the driver door is open, the headlight switch is set to <b>AUTO</b>, and the low light sensor detects darkness. The delay period starts once the last vehicle door or the rear hatch is closed.</p>
Switch off:	<ul style="list-style-type: none"> <li>– Automatically after the preset delay period is over.</li> <li>– Automatically if any door or the rear hatch is still open about 60 seconds after activation.</li> <li>– Turn the light switch to the <b>0</b> position.</li> <li>– Switch on the ignition.</li> </ul>

“Leaving home”	Action
Switch on:	<ul style="list-style-type: none"> <li>– Unlock the vehicle when the light switch is <i>not</i> in the <b>0</b> position and the low-light sensor registers <i>darkness</i>. Unlock the vehicle if the light switch is in the <b>AUTO</b> position and the low-light sensor registers darkness.</li> </ul>
Switch off:	<ul style="list-style-type: none"> <li>– Automatically after the preset delay period is over.</li> <li>– Lock the vehicle.</li> <li>– Turn the light switch to the <b>0</b> position.</li> </ul>

“Leaving home”	Action
	– Switch on the ignition.

### Background lighting in the outside mirrors

The background lighting in the outside mirrors lights up the area close to the doors while you are getting into or out of the vehicle. It is switched on when the vehicle is unlocked, a vehicle door is opened, or the “Coming home” or “Leaving home” feature is activated. If the vehicle is equipped with a light sensor, the background lighting in the outside mirrors is only switched on in darkness.

 The lights stay on for about 10 seconds (lighting delay period). The “Coming home” and “Leaving home” features can be enabled and disabled in the Infotainment System.

 If the “Coming home” feature is switched on and the driver door is opened, no acoustic warning will sound to alert that the light is still on.

## Instrument panel lighting and headlight range adjustment



**Fig. 86** Next to the steering wheel: Control for instrument cluster lighting.

 Please first read and note the introductory information and heed the **WARNINGS** 

### Instrument panel lighting

When the lights are on, the brightness of the instrument panel lighting is adjusted by turning the thumbwheel ⇒ [fig. 86](#).

- Push and release button; the button pops out to let you change the adjustment.
- Set the desired brightness and push the button back in.

In vehicles with daytime running lights (DRL), the instrument cluster lighting switches off automatically when it is dark outside or when driving through tunnels, for example. You will need to switch the headlights on manually when this happens, so that the vehicle's taillights will turn on

### Dynamic headlight range adjustment on vehicles with Adaptive Front Lighting System

The headlight range is automatically adjusted to the vehicle loading once the Adaptive Front Lighting System is switched on.

**⚠ WARNING**

Headlights that are aimed too high because of the way the vehicle is loaded can blind and distract other drivers. This can lead to a crash and serious personal injuries.

- Always adjust headlights to loading conditions so that the light cone do not blind others.





**⚠ WARNING**

If dynamic headlight range adjustment does not work properly or at all, the headlights could blind and distract other drivers. This can lead to a crash and serious personal injuries.

- Have headlight range adjustment checked immediately by an authorized Volkswagen dealer or an authorized Volkswagen Service Facility.

## Interior and reading lights

☑ Please first read and note the introductory information and heed the WARNINGS ⚠

Button	Function
0	Interior lights off.
	Interior lights on.
	Door contact switch-center position.  Interior lights go on automatically when the vehicle is unlocked, a door is opened, or the vehicle key is removed from the ignition.  The lights go out again a few seconds after you close the door. They also go out when you lock the vehicle or switch on the ignition.
	Reading light on or off.
	



### Glove and luggage compartment lights

The glove compartment and luggage compartment may have lights that come on automatically when they are opened and go off when they are closed.

### Footwell lighting

The footwell lighting lights up the front footwells on the driver and passenger sides when the parking lights or low beams are switched on.

The brightness can be adjusted in the Infotainment System.

- Press the **CAR** Infotainment button.
- Tap the **Settings** function key on the screen.
- Select the menu item **Lights and vision** in the list.
- Select the menu item **Footwell light** or **Ambient lighting** from the sub-menu.
- Place your finger on the touchscreen slider  and, *keeping your finger on the screen*, move your finger to drag the slider to the desired brightness.
- **OR:** Tap the  or  function key on the screen to move the slider in steps.

### **Background lighting**

When the ignition and headlights are switched on, the roof console control buttons light up.

There may also be footwell lighting.

The brightness is set using the instrument lighting control



The interior and reading lights go out when you lock the vehicle or a few minutes after you remove the vehicle key from the ignition. This helps to prevent unnecessary drain on the vehicle battery.



You have to push the  button *twice* to switch on a reading light that has been automatically switched off.

## Sun protection

### Introduction

---

In this section you'll find information about:

Sun visors

Windshield made of heat-insulating glass

Rear side window sunshade

#### **WARNING**

Sun visors and side window shades can reduce visibility.

- Always stow sun visors and side window shades when not needed to block sun glare.

### Sun visors

---

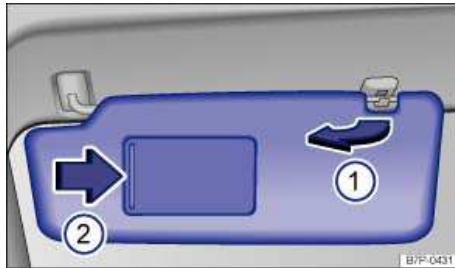

Fig. 87 Sun visor.

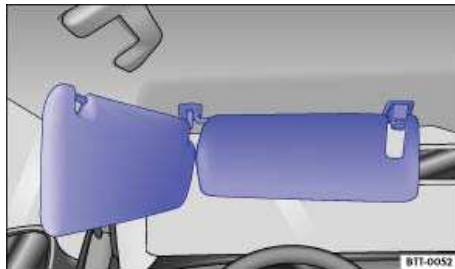

Fig. 88 Double sun visors.

 Please first read and note the introductory information and heed the WARNINGS 



### Sun visor adjustment:

- Flip the sun visor down toward the windshield.
- Lift out of mounting and move toward the doors ⇒ [fig. 87 \(1\)](#).
- Rotate the sun visor toward the door.

### Vanity mirror and lighting

A vanity mirror is behind a cover in the sun visor. When the cover is slid open (2), the light comes on. The light goes out when you shut the cover or if you flip the sun visor up again.

 The vanity mirror light goes out after several minutes. This helps to prevent unnecessary drain on the vehicle battery.

## Windshield made of heat-insulating glass

---

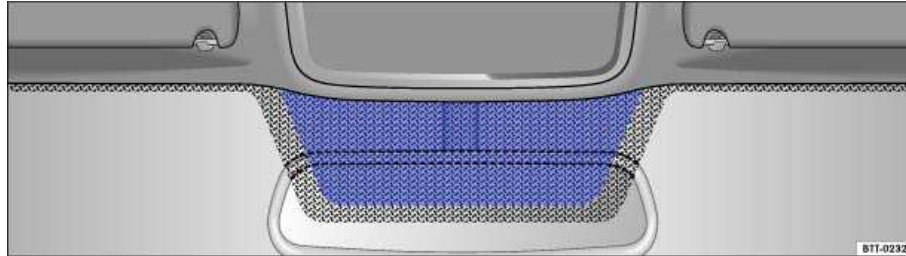

[Fig. 89](#) Heat-reflective windshield with communications window (blue shaded area).

 **Please first read and note the introductory information and heed the WARNINGS** 

Windshields made of insulating glass have a transparent metallic infrared-reflecting coating. There is an uncoated area (communications window) just above the inside rear view mirror ⇒ [fig. 89](#). This serves as a communications window for transmitting signals to and from electronic components and accessories.

The uncoated area must not be blocked on the inside or outside or covered with stickers because this can cause the electronic components to malfunction.

## Rear side window sunshade

---

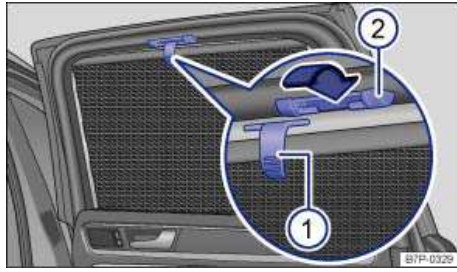

Fig. 90 Sunshade in the rear right window.

**⚠ Please first read and note the introductory information and heed the WARNINGS ⚠**

The sunshades for the rear side windows are integrated into the side trim of the respective window.

- Pull the sunshade all the way up by the projecting handle ⇒ fig. 90 (1).
- Insert each eye of the handle into the corresponding mount (2). Make sure that the extended sunshade is safely hooked into both mounts (2).
- Unhook the sunshade at the top and guide it down to retract the blind ⇒ ⚠.

### ⚠ NOTICE

To help prevent damage to the shade or the interior rim, do not let the sunshade retract “quickly.”

# Windshield wiper and washer

## Introduction

---

In this section you'll find information about:

- Indicator lights
- Windshield wiper lever
- Windshield wiper functions
- Windshield wiper service position
- Rain sensor
- Checking and refilling windshield washer fluid

### More information:

- Exterior views
- Climate control
- Working in the engine compartment
- Exterior care and cleaning

 **WARNING**

Windshield washer fluid without enough frost protection can freeze on the windshield and reduce visibility.

- Use the windshield washer system with enough frost protection for winter temperatures.
- Never use the windshield wipers/washers when it is freezing without first defrosting the windshield. The washer solution may freeze on the windshield and reduce visibility.

 **WARNING**

Worn or dirty wiper blades reduce visibility and increase the risk of accidents and severe injuries.

- Always replace wiper blades that are worn, damaged, or do not keep the windshield clear.



 **NOTICE**

To help prevent damage to the wiper blades and the wiper motor when it is cold outside, always make sure that blades are not frozen to the windshield before operating the wipers. Using the windshield wiper service position can be helpful in cold weather, so the wipers do not freeze to the windshield ⇒ *Windshield wiper service position*.

## Indicator lights

---

 Please first read and note the introductory information and heed the WARNINGS 

Lights up	Possible cause	Proper response
	Rain sensor malfunction.	Switch ignition off and on again. If the indicator light comes on again and stays on, contact an authorized Volkswagen dealer or an authorized Volkswagen Service Facility
	Windshield and/or rear window wiper malfunction.	Switch ignition off and on again. If the indicator light comes on again and stays on, contact an authorized Volkswagen dealer or an authorized Volkswagen Service Facility
	Windshield and rear window washer fluid level too low.	Refill windshield washer reservoir at the next opportunity

When the ignition is switched on, several warning and indicator lights come on briefly for a function check. They go out after a few seconds.

### NOTICE

Failure to heed warning lights or text WARNINGS can result in vehicle damage.

### Windshield wiper lever

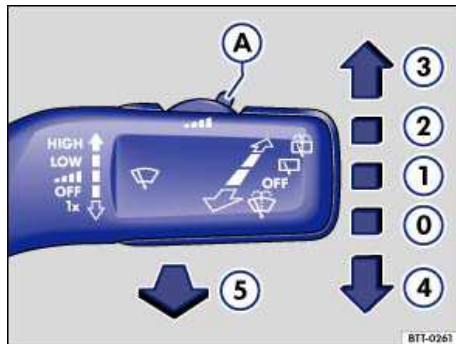

Fig. 91 Operating the front windshield wiper.

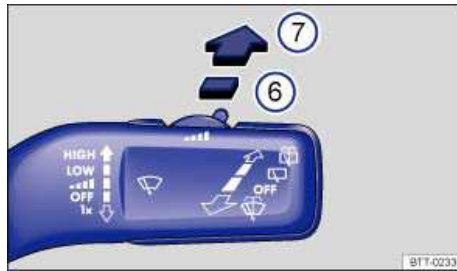

Fig. 92 Operating the rear wiper.

☑ Please first read and note the introductory information and heed the WARNINGS ⚠

Move the lever to the desired position ⇒ ⚠:

(0)	OFF	Wiper switched off.
(1)	•••	Intermittent wiping for the windshield. Adjust the interval settings with switch ⇒ <a href="#">fig. 91 (A)</a> (vehicles without rain sensors) or the sensitivity of the rain sensor (vehicles with rain sensors).
(2)	LOW	Slow wiper speed (speed 1).
(3)	HIGH	Fast wiper speed (speed 2).
(4)	1x	Tap and release lever for <i>one</i> wipe cycle at speed 1. Push lever down longer for speed 2 wipe cycle.
(5)		Pull the lever toward the steering wheel to activate the windshield washers, then release.
(6)		Intermittent wiping for the rear window. The wiper wipes about every 6 seconds.
(7)		Press the lever forward as far as it will go to activate the rear window washers, then release.

#### ⚠ NOTICE

- To help prevent damage to the wiper blades and the wiper motor when it is cold outside, always make sure that blades are not frozen to the windshield before operating the wipers. Using the service position can be helpful in cold weather so the wipers do not freeze to the windshield ⇒ *Windshield wiper service position*.

- If the ignition is switched off while the wipers are running, the wipers will continue at the same wiping speed when the ignition is switched on again. Frost, ice, snow, leaves, and other objects on the windshield can damage the wipers and the wiper motor.
- Remove snow and ice from the wipers before you begin driving.
- If the wiper blades freeze to the windshield, loosen them carefully. Volkswagen recommends using a deicing spray.

## NOTICE

**Never switch on the windshield wipers when the windshield is dry because the windshield can be scratched.**

 The windshield wipers work only if the ignition is switched on and the engine hood is closed. The windshield wipers turn off automatically when the engine hood is opened. The rear windshield wipers turn off automatically when the rear hatch is opened.

 If the front wipers are on, the rear wiper is switched on automatically whenever the car is put into reverse.

 If the windshield wiper lever is in the rear window intermittent wiping position ⇒ [fig. 92 \(6\)](#) when the ignition is switched off and back on or the engine is started, rear window wiper action does not resume until the windshield wipers are activated. This is to keep the wiper from working when the window is dry. By switching rear window intermittent wiping off and then back on, you can override this feature and activate the rear window wiper immediately.

 The intermittent wiping for the front windshield depends on the driving speed. The higher the speed, the faster the wipers move.

 If the wiper blades freeze to the windshield, loosen them carefully. Volkswagen recommends using a deicing spray.

 If the front wipers are on, the rear wiper is switched on automatically when backing up.

## Windshield wiper functions

 Please first read and note the introductory information and heed the WARNINGS 

### Wiper performance in different situations:

---

When the vehicle is not moving:

The wiper speed changes temporarily to the next lower speed.

---

## Wiper performance in different situations:

---

During automatic wiper/wash:

While the washer system is working, the climate control system switches to recirculation for about 30 seconds to help prevent the washer fluid odor from entering the vehicle interior.

---

During intermittent wiping:

Speed-dependent interval control: The higher the vehicle speed, the faster the wipers move.

### Heated washer nozzles

The heating thaws frozen washer nozzles, but not the fluid supply hoses. When the ignition is switched on, the heat applied to the washer nozzles is automatically regulated depending on the outside air temperature.

### Headlight washer system

The headlight washer system cleans the headlight lens.

If the ignition and the headlights (high or low beams) are switched on, the headlights are cleaned the first time and every fifth time the front windshield washers are activated. This happens only when the low or high beams are on when the windshield wiper lever is pulled towards the steering wheel. However, the headlights must still be washed by hand periodically (for instance, during fueling) in order to get rid of hard-to-remove dirt (like insect splatter).

To help make sure that the headlight washer system works during winter weather, always keep the headlight washer nozzles free of snow and remove any ice with a deicer spray before driving. Use a deicer spray to remove any ice.



If there is something on the windshield, the wiper will try to wipe it away. If it continues to block the wiper, the wiper will stop moving. Remove the obstacle and switch the wiper on again.

## Windshield wiper service position

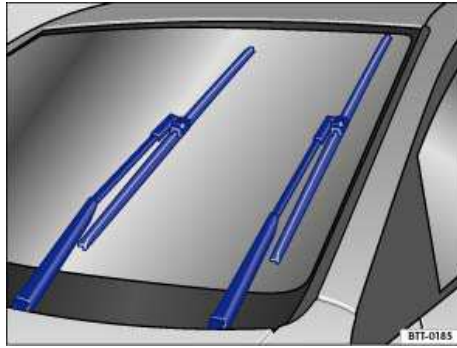

Fig. 93 Windshield wiper in service position.

**ⓘ Please first read and note the introductory information and heed the WARNINGS ⚠**

In the service position, the wiper arms can be lifted away from the windshield ⇒ fig. 93. The wipers are moved to the service position as follows:

### Manual activation of service position

- The engine hood must be closed ⇒ *Working in the engine compartment*.
- Switch the ignition off, turn it on briefly, and then off again.
- Press the windshield wiper lever down briefly ⇒ fig. 91 (4) when the ignition is off.
- Wipers move into service position.

### Activating service position in the Infotainment System

- The engine hood must be closed ⇒ *Working in the engine compartment*.
- Switch on the ignition.
- Press the **CAR** Infotainment button.
- Tap the **Service** function key on the screen.
- Tap the function key **Wipers in service pos.** to activate or deactivate the service position.

If the box in the **Wipers in service pos.** function key is checked , the feature is switched on ⇒ fig. 316.

Fold the wiper arms back onto the windshield before driving! The wiper arms will move back to their original position after driving off or when the windshield wiper lever is activated.

### Lifting and the wiper blades and tilting them away from the windshield

- Put the wiper arms to the service position ⇒ ⚠.
- Do not touch the wiper blades; grasp the wiper arms only at the bracket above the wiper blades.

### ⚠ NOTICE

- **To help prevent damage to the engine hood and the windshield wiper arms, lift the wiper arms away from the windshield only when they are in the service position.**



- Always carefully fold the windshield wiper arms down against the windshield before driving the vehicle

## Rain sensor

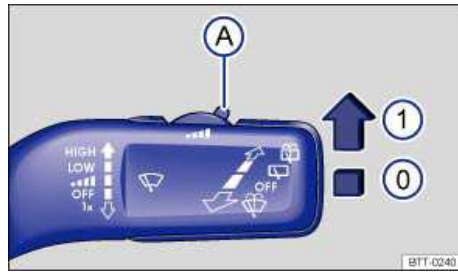

Fig. 94 Windshield wiper lever: Adjusting rain sensor A.

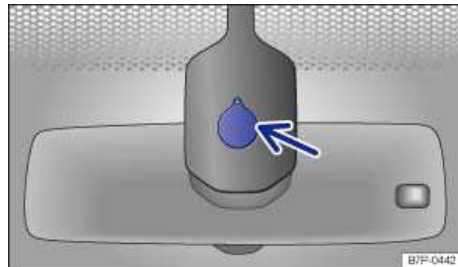

Fig. 95 Sensitive rain sensor surface.

### **⚠ Please first read and note the introductory information and heed the WARNINGS ⚠**

When switched on, the rain sensor automatically shortens or lengthens the delay between wiping cycles depending on how hard it is raining ⇒ ⚠. The rain sensor's sensitivity can be adjusted manually. Manual wiping (vehicles without rain sensors) ⇒ *Windshield wiper lever*.

The rain sensor has to be enabled in the Infotainment System.

Push the lever into the desired position ⇒ fig. 94:

- (0) Rain sensor off (windshield wiper lever home position).
- (1) Rain sensor active – automatic wiping as needed.
- (A) Adjusting the sensitivity of the rain sensor:
  - Move switch to the right – high sensitivity.
  - Move switch to the left – low sensitivity.

After switching the ignition off and back on again, the rain sensor stays on and works again with the wiper lever in position (1) when the vehicle speed is over 10 mph (16 km/h).

Even if the rain sensor is disabled, it is still necessary to reach this speed to reactivate the wipers when the windshield wiper lever is in the intermittent wiping position. The wipers then wipe at fixed intervals instead of wiping as needed, as they do in rain sensor mode.

### **Enabling and disabling the rain sensor in the Infotainment System**

- Switch on the ignition.

- Press the **CAR** Infotainment button.
- Tap the **Assist systems** function key on the screen.
- Tap the function key **Rain sensor** to enable or disable the rain sensor.

If the box in the **Rain sensor** function key is checked , the feature is enabled.

#### Possible reasons for changes in the way the rain sensor works

The rain sensor may misread what is happening in the *detection zone of its sensitive rain-sensor surface* ⇒ [fig. 95](#) (arrow) and not work for a number of reasons, which include:

- Worn out wiper blades: Worn out wiper blades may leave a film of water or wiping streaks; this can cause the wipers to run longer, to wipe more often, or to wipe continuously at high speed.
- Insects: Insects hitting the sensor cause wiping.
- Salt streaks: Salt streaks on the windshield from winter driving can cause wiping more often or continuously on glass that is almost dry.
- Dirt: Caked-on dust, wax, any other buildup on the windshield (lotus effect), or car-wash detergent residue can lower the rain sensor's sensitivity and cause it to react too slowly or not at all.
- Crack in the windshield: If a stone hits and chips the sensitive surface while the rain sensor is on, this will trigger a wiper cycle. After that, the rain sensor will recognize the change and recalibrate itself to respond to the smaller detection zone. Depending on the size of the chip, the sensor's reaction pattern may or may not change.

**⚠ WARNING**

**The rain sensor cannot always recognize rain and activate the wipers.**

- **Switch the wipers on manually when water on the windshield reduces visibility.**

**i** Clean the sensitive area of the rain sensor regularly and check the wiper blades for wear or damage.

**i** To remove wax and coats of polish safely, we recommend using an alcohol-based windshield cleaner.

### Checking and refilling windshield washer fluid

---



**Fig. 96** In the engine compartment: Cap of the windshield washer fluid reservoir.

**ⓘ Please first read and note the introductory information and heed the WARNINGS ⚠**

Check the windshield washer fluid level regularly and refill as necessary.

There is a filter screen in the filler neck of the windshield washer fluid reservoir. The screen helps to keep large particles and debris from getting into and clogging the windshield washer nozzles when adding windshield washer fluid. Take the screen out only to clean it. If the screen is damaged or missing, have it replaced immediately, otherwise the system may become clogged and not work properly.

- Open the engine hood ⚠
- The windshield washer fluid reservoir can be identified by the 🚰 symbol on its cap ⇒ fig. 96.
- Check if there is still enough windshield washer fluid in the reservoir.
- Refill with an appropriate windshield washer fluid that is recommended by Volkswagen ⇒ ⓘ.  
Follow the directions on the container.
- In cold weather, always use a special windshield washer antifreeze solution that will help keep the water from freezing ⇒ ⚠.

**Recommended cleaners**

- For the warmer months, Windscreen Clear SummerG 052 184 A1 or equivalent. Mixing ratio 1:100 (1 part concentrate to 100 parts water) in the windshield washer reservoir.
- All-season Windscreen ClearG 052 164 A2 or equivalent. the mixing ratio in winter to 0 °F (-18 °C) about 1:2 (1 part concentrate to 2 parts water), otherwise, mixing ratio 1:4 in the windshield washer reservoir.

**Filling capacity**

The windshield washer fluid reservoir holds about 4.5 liters; in vehicles with a headlight washer system about 8 qts (7.5 liters).

**⚠ WARNING**

**Never mix antifreeze or similar additives into the windshield washer reservoir. This could produce an oily film on the windshield, which would considerably reduce visibility.**

- Use clear water with a cleaning solution recommended by Volkswagen.
- If necessary, blend with a suitable windshield washer fluid antifreeze agent.

**ⓘ NOTICE**

- Never mix cleaning solutions recommended by Volkswagen with other cleaning agents. If you do, this could cause sediments or other by-products that can clog the windshield wiper nozzles.
- When refilling, do not confuse one type of operating liquid with another! Otherwise serious malfunctions and engine damage can occur!

# Mirrors

## Introduction

---

In this section you'll find information about:

Inside mirror

Outside mirrors

For your driving safety, it is important that you properly adjust the outside mirrors and the inside mirror before you start driving ⇒ .

The outside mirrors and the inside mirror help you see and adapt your driving to traffic behind you. Remember that the inside and outside rearview mirrors will not show everything behind you. There can be blind spots. Blind spots can be significantly larger if the mirrors are not properly adjusted.

### More information:

- Exterior views
- Volkswagen Information System
- Adjusting the seating position
- Memory seats
- Shifting gears
- Braking and parking

### WARNING

Adjusting mirrors when the vehicle is moving can cause driver distraction, accidents, and serious personal injury.

- Always adjust the rearview mirrors when the vehicle is not moving.
- Always be aware of what is happening around the vehicle when changing lanes, passing, turning, or parking. Another vehicle, pedestrian, or object could be in your blind spot.
- Always make sure mirrors are properly adjusted and the view to the rear is not reduced by moisture, ice, snow, or other things.

### WARNING

Auto-dimming mirrors contain an electrolyte fluid which can leak if the mirror glass is broken. Electrolyte fluid can irritate the skin, eyes, and respiratory system.

- Repeated or prolonged exposure to electrolyte fluid can irritate the respiratory system, especially among people with asthma or other respiratory conditions. Get fresh air immediately by leaving the vehicle or, if that is not possible, open windows and doors all the way.
- If electrolyte fluid gets into the eyes, flush them thoroughly with large amounts of clean water for at least 15 minutes; medical attention is recommended.
- If electrolyte fluid contacts skin, flush affected area with clean water for at least 15 minutes and then wash affected area with soap and water; medical attention is recommended. Thoroughly wash affected clothing and shoes before reuse.
- If swallowed, and the person is conscious, rinse mouth with water for at least 15 minutes. Get medical attention immediately. Do not induce vomiting unless instructed to do so by a medical professional.

**NOTICE**

Broken glass in the auto dimming mirrors can cause electrolyte fluid leakage. Liquid electrolyte leaked from a broken mirror glass will damage any plastic surfaces it comes in contact with. Clean up spilled electrolyte fluid immediately with clear water and a sponge.

## Inside mirror

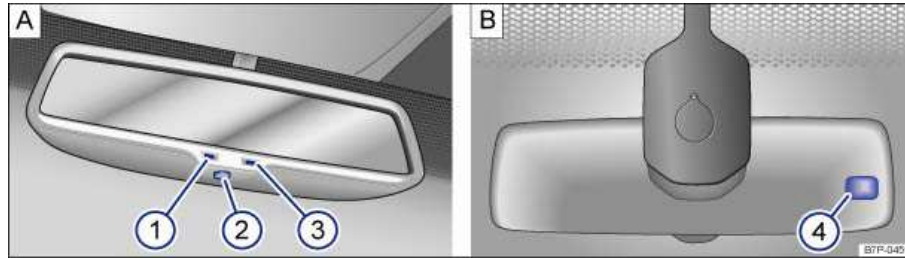

Fig. 97 Auto-dimming inside mirror (if applicable).

**ⓘ Please first read and note the introductory information and heed the WARNINGS ⚠**

Adjust the inside mirror to make sure that there is good visibility through the rear window.

For example, visibility through the rear window could be impaired if there is a sunshade on the rear window or clothing on the luggage compartment cover, or if the rear window is covered with ice, snow, or dirt.

### Auto-dimming inside mirror (if applicable)

Key to fig. 97:

- (1) Indicator light
- (2) Switch
- (3) Sensor for recognizing entry of light from rear
- (4) Sensor for recognizing entry of light from front

The auto-dimming feature can be switched on and off with the switch on the inside mirror (2). When auto-dimming is activated, the indicator light (1) is on.

If the ignition is switched on, the sensor (3) *automatically* darkens the inside mirror depending on the amount of light shining into the vehicle from the rear.

The auto-dimming feature is deactivated when you shift the transmission into reverse or switch on the interior lights or the reading light.

Do not attach external navigation devices to the windshield or in the vicinity of the auto-dimming inside mirror ⇒ ⚠.

**⚠ WARNING**

The illuminated display on an external navigation device can cause the auto-dimming inside mirror to malfunction, which can result in crashes and serious injuries.

- Malfunctions in the auto-dimming function can result in the rearview mirror being unable to evaluate the exact distance of vehicles in the rear or other objects.

 If the light striking the sensor is filtered or blocked (such as by a sunshade), the auto-dimming inside mirror will not work properly or may not work at all.

## Outside mirrors

---

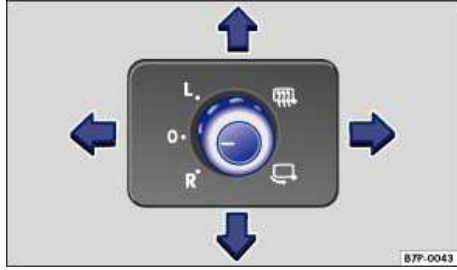





Fig. 98 In the driver door: Adjusting knob for outside mirrors.

 Please first read and note the introductory information and heed the WARNINGS 

### Turn the rotary knob to the desired position:

---

- |   |  |
|---|--|
|  | Fold the outside mirror in toward the vehicle body ⇒  . |
|  | Switch on outside mirror heating. Heats only at outside air temperatures below +68 °F (+20 °C).  |
| <b>L</b>  | Adjust the left outside mirror by pressing the knob to left/right and up/down.   |
| <b>R</b>  | Adjust the right outside mirror by pressing the knob to left/right and up/down.  |
| <b>O</b>  | Neutral position. Outside mirror folded out, no heating or adjustment possible.  |

### Memory for front passenger side mirror (when backing up)

- Choose the remote control vehicle key that will be used with the settings about to be made.
- Unlock the vehicle with that remote control key.
- Set the electronic parking brake.
- Shift the transmission into neutral.
- Switch on the ignition.

- Press the **CAR** Infotainment button.
- Tap the **Settings** function key on the screen.
- Select **Seat settings** from the list.
- Check the check box in the **Driver seat remote control key**  function key.
- Shift the transmission into reverse.
- Adjust the passenger outside mirror for a clear view of the curb, for example.
- The adjusted mirror position is automatically stored and assigned to the vehicle key that used to unlock the vehicle. The preselected position will be recalled when the key assigned to that mirror adjustment position is used again. For vehicles with memory seat

#### Recalling passenger side mirror settings

- Turn the adjusting knob for the side mirrors to the **R** position.
- Shift the transmission into reverse gear with the ignition switched on.
- The mirror moves back to the regular position when the vehicle moves forwards faster than about 10 mph (15 km/h) or the adjusting knob is turned to the **O** or **L** position.

#### **WARNING**

Improper use of the folding outside mirrors can cause personal injury.

- Always make sure that nobody is in the way when folding the mirrors in or out.
- Make sure that you do not get your finger caught between the mirror and the mirror base when moving the mirrors.

#### **WARNING**

Incorrectly estimating distances with the right outside mirror can cause collisions and serious injury.

- The right outside mirror has a convex (curved) surface. This widens your field of vision. But vehicles or other objects seen in a convex mirror will look smaller and farther away than they really are.
- If you use the right outside mirror to judge distances from vehicles behind you when changing lanes, you could estimate incorrectly and cause a crash and serious injuries.
- Whenever possible, use the inside mirror to more accurately judge distance and size of vehicles or other objects seen in the convex mirror.
- Always make sure you have a clear view to the rear of the vehicle.

#### **NOTICE**

- Always fold in the outside mirrors when taking the vehicle through an automatic car wash.
- Never fold power mirrors in manually because doing so could damage the electrical drive.



To reduce fuel consumption, use outside mirror heating only when needed.



When first switched on, outside mirror heating works with maximum heat for about 2 minutes.



If power mirror adjustment does not work, the outside mirrors can be adjusted by hand by pressing on the edges of the mirror surface.

# Driving tips

## Introduction

---

In this section you'll find information about:

- Stowing luggage
- Driving with an open rear hatch
- Driving a loaded vehicle
- Weights and axle weights

Always stow heavy objects in the luggage compartment and make sure that the rear seat backrests are securely latched. Always use the tie-downs in the luggage compartment and secure the objects with suitable straps. Never overload the vehicle. Remember that the vehicle load, as well as how it is distributed, can affect vehicle handling and braking ⇒ .

### More information:

- Rear hatch
- Lights
- Luggage compartment
- Folding down the passenger seat backrest
- Roof rack
- Trailer towing
- Tires and wheels

### WARNING

Unsecured or incorrectly stowed items can fly through the vehicle, causing serious personal injury during hard braking or sharp steering or in an accident. Loose items can also be struck and thrown through the passenger compartment by the front airbags if they inflate. To help reduce the risk of serious personal injury:

- Always stow all objects securely in the vehicle.
- Always keep storage compartments closed while driving.
- Do not stow hard, heavy, or sharp objects in open bins in the vehicle or on top of the instrument panel.
- Remove hard, heavy, and sharp objects from clothing and bags in the vehicle interior and stow securely. Always put heavy items in the luggage compartment.
- Always secure objects in the passenger compartment properly with suitable straps so that they cannot move into the deployment area of a side or front airbag during braking in a sudden maneuver, or in a collision.
- Always make sure that there is nothing on the front passenger seat when the backrest is folded forward. When the backrest is folded forward, even light objects could be pushed into the seat cushion and cause the weight-sensing mat in the seat to register enough weight to turn the airbag on.
- Always make sure that the PASSENGER AIR BAG OFF  light is on and stays on whenever the backrest of the front passenger seat is folded forward
- Passengers must never ride in an incorrect seating position because objects are being transported in the vehicle.
- Never let anybody sit in a seat that is blocked by objects being carried in the vehicle.



## WARNING

Heavy loads will influence the way your vehicle handles and increase stopping distances. Heavy loads that are not properly stowed or secured can cause loss of control and serious injury.

- Secure the load properly to keep it from shifting.
- Always remember when transporting heavy objects that a change in the center of gravity also changes the way your vehicle handles:
  - Always distribute the load as evenly as possible.
  - Secure heavy objects properly as far forward in the luggage compartment as possible.
  - Always tie down heavy items securely with suitable straps using the tie-downs in the luggage compartment.
- Securely latch the rear seat backrest in the upright position.
- Never exceed the Gross Axle Weight Rating or the Gross Vehicle Weight Rating on the safety compliance sticker on the left door jamb. Exceeding permissible weight can cause the vehicle to skid and handle differently.
- Always adapt your speed and driving to the heavier load and the weight distribution in the vehicle. Take road, weather, traffic, and visibility conditions into account as well.
- Drive especially carefully and accelerate gently.
- Always accelerate and avoid sudden braking and driving maneuvers.
- Always brake earlier than you would if you were not driving a loaded vehicle.

## Stowing luggage

 Please first read and note the introductory information and heed the WARNINGS 

### Always stow all luggage securely in the vehicle

- Distribute the load in the vehicle, on the roof and in the trailer as evenly as possible.
- Put heavy objects as far forward as possible in the luggage compartment and securely latch the rear seat backrest in the upright position.
- Secure luggage in the luggage compartment to the tie-downs with suitable straps ⇒ *Luggage compartment*.
- Adjust the headlight range ⇒ *Lights*.
- Check the pressure in all 4 tires when the tires are still cold. Never reduce air pressure in warm tires to match cold tire inflation pressure. Heed the information on the tire pressure label ⇒ *Tires and wheels*.
- Pay especially close attention to your vehicle's Tire Pressure Monitoring System (TPMS) when driving with a heavy load ⇒ *Tire Pressure Monitoring System (TPMS)*.

## NOTICE

The defroster heating wires or antenna in the rear window can be damaged by objects that rub against them.

 Please review information about loading a trailer and a roof rack ⇒ *Roof rack*.

## Driving with an open rear hatch

 Please first read and note the introductory information and heed the WARNINGS 

Driving with an open rear hatch can lead to serious personal injury. If you have to drive with an open rear hatch, make sure that all objects and the lid itself are properly secured and take appropriate measures to keep toxic exhaust fumes from entering the vehicle.

### WARNING

Driving with an unlatched or open rear hatch can lead to serious personal injuries.

- Never transport objects larger than those fitting completely into the luggage compartment, because the rear hatch cannot be closed properly.
- After closing the rear hatch, always pull up on it to make sure that it is properly closed and cannot open suddenly when the vehicle is moving.
- Always stow all objects securely in the luggage compartment. Loose objects can fall out of the luggage compartment and injure others on the road behind you.
- Drive carefully; anticipate what other drivers will do.
- Avoid abrupt or sudden driving or braking maneuvers, because the unlatched rear hatch can move suddenly.
- Always mark objects sticking out from the luggage compartment clearly for others to see. Obey all applicable legal requirements.
- Never use the rear hatch to “clamp” or “hold” objects protruding from the luggage compartment.
- Always remove any luggage rack or other rack mounted on the rear hatch (along with any luggage on the rack) before driving with an open rear hatch.

### WARNING

Driving with an open rear hatch can cause poisonous carbon monoxide in the engine exhaust to get into the passenger compartment.

- Carbon monoxide causes drowsiness, inattentiveness, poisoning, and loss of consciousness. It can lead to accidents and severe personal injuries.
- Always keep the rear hatch closed while driving to help keep poisonous exhaust fumes from being drawn into the vehicle.
- Never transport objects that are too large to fit completely into the luggage area, because then the rear hatch cannot be fully closed.
- If you absolutely must drive with an open rear hatch, do the following to reduce the risk of carbon monoxide poisoning:
  - Close all windows and the power sunroof.
  - Switch off the climate control system's air recirculation feature.
  - Open all air vents in the instrument panel.
  - Set the fresh air fan to the highest speed.

### NOTICE

The open rear hatch changes the vehicle's length and height.

## Driving a loaded vehicle

---

 Please first read and note the introductory information and heed the WARNINGS 

For good handling when driving a loaded vehicle, please observe the following:

- Securely stow all luggage ⇒ *Stowing luggage*.
- Drive especially carefully and accelerate gently.
- Avoid sudden braking and driving maneuvers.
- Brake earlier than you would if you were not driving a loaded vehicle.
- If applicable, observe information about driving with a trailer ⇒ *Trailer towing*.
- If applicable, observe information about driving with a roof rack ⇒ *Roof rack*.

### WARNING

**Heavy loads can change the way your vehicle handles and increase stopping distances. Heavy loads that are not properly stowed or secured can shift suddenly, causing loss of control and serious injury.**

- Secure the load properly to keep it from shifting.
- Always remember when transporting heavy objects that they change the vehicle's center of gravity and also the way it handles
  - Always distribute the load as evenly as possible.
  - Secure heavy objects properly as far forward in the luggage compartment as possible.
  - Use your vehicle's luggage compartment tie-downs with suitable straps.
  - Always tie down heavy items securely with suitable straps.
- Securely latch the rear seat backrest in the upright position.
- Never exceed the Gross Axle Weight Rating or the Gross Vehicle Weight Rating on the safety compliance sticker on the left door jamb. Exceeding permissible weight can cause the vehicle to skid and handle differently.
- Always adapt speed and driving to the heavier load and the weight distribution in the vehicle. Take road, weather, traffic, and visibility conditions into account as well.
- Always accelerate gently and avoid sudden braking and driving maneuvers.
- Always brake earlier than you would if you were not driving a loaded vehicle.

## Weights and axle weights

---

 Please first read and note the introductory information and heed the WARNINGS 

The actual gross weight of any vehicle depends on the engine, basic equipment, any factory-installed optional equipment for the given model, and any accessories that have been installed. The Gross Vehicle Weight Rating (GVWR) and the Gross front and Rear Axle Weight Ratings (GAWR) for a given vehicle are printed on the vehicle's Safety Compliance Certification Label on the driver door jamb.

The **Gross Vehicle Weight Rating** includes the weight of the vehicle itself with all of its factory-installed equipment, plus a full tank of gasoline, the engine oil and coolant, all vehicle occupants (150 lbs / 68 kg per seating position) and cargo.

The **Gross Axle Weight Ratings** specify the maximum allowable load for each axle.

Determining the Gross Vehicle Weight Rating ⇒ *Tires and wheels*.

The cargo payload may not be increased by using a roof rack without commensurately reducing the weight from vehicle occupants ⇒ ⚠. Determining the Gross Vehicle Weight Rating ⇒ *Tires*.

Vehicle payload consists of the combined weight of the following:

- Passengers.
- Total luggage and other cargo.
- Factory-installed or retrofitted accessories.
- Roof load including roof rack system.
- Hitch weight and tongue weight for trailer towing operation.

Please refer to the Gross Vehicle Weight Rating (GVWR) and the Gross front and rear Axle Weight Ratings (GAWR) for your vehicle, which are printed on the vehicle's Safety Compliance Certification Label on the driver door jamb.



#### **WARNING**

**Exceeding maximum permissible weight ratings can result in vehicle damage, accidents, and serious personal injury.**

- **Never let the actual weights at the front and rear axles exceed the permissible Gross Axle Weight Rating. Also, never let the total of these actual weights exceed the Gross Vehicle Weight Rating.**
- **Always remember that the vehicle's handling and braking will be affected by extra load and the distribution of this load. Adjust your speed accordingly.**



#### **NOTICE**

- **Always distribute the load evenly and as low as possible in the vehicle. The vehicle capacity weight figures apply when the load is distributed evenly in the vehicle (passengers and luggage).**
- **When transporting a heavy load in the luggage compartment, carry the load as close to the rear axle (as far forward) as possible so that the vehicle's handling and braking are affected as little as possible.**

# Luggage compartment

## Introduction

---

In this section you'll find information about:

Folding the backrest of the rear bench forward and back into place

Luggage compartment cover

Luggage compartment pass-through

Tie-downs

Shopping bag hook

Luggage compartment floor

Always stow heavy objects in the luggage compartment and make sure that the rear seat backrests are securely latched in their upright position. Always secure objects to the tie-downs with suitable straps. Never overload the vehicle. Remember that the vehicle load, as well as how it is distributed,

can affect vehicle handling and braking ⇒ .

### More information:

- Adjusting the seating position
- Safety belts
- Airbag system
- Lights
- Transporting
- Trailer towing
- Tires and wheels

### WARNING

**An open or unlocked luggage compartment poses special risks for children.**

- **Close and lock the rear hatch and all doors when the vehicle is not in use. First, make certain that no one is left inside.**
- **Never leave your vehicle unattended or let children play around the vehicle, especially with the rear hatch left open. A child could crawl into the vehicle and pull the hatch shut, becoming trapped and unable to get out. This could cause severe or fatal injuries.**
- **A closed vehicle can become very hot or very cold, depending on the season. Temperatures can quickly reach levels that can cause unconsciousness or death, particularly to small children.**
- **Never let children play in or around the vehicle.**
- **Never let anyone ride in the luggage compartment.**



## WARNING

Unsecured or incorrectly stowed items can fly through the vehicle, causing serious personal injury during hard braking or sharp steering or in an accident. Loose items can also be struck and thrown through the passenger compartment by the front airbags if they inflate. To help reduce the risk of serious personal injury:

- Always stow all objects securely in the vehicle. Always put luggage and heavy items in the luggage compartment.
- Always secure objects in the passenger compartment properly with suitable straps so that they cannot move into the deployment zone of a side or front airbag during a sudden braking, in a sudden maneuver, or in a collision.
- Always keep storage compartments closed while driving.
- Never stow hard, heavy, or sharp objects in the vehicle's open storage compartments, on the shelf behind the rear seat bench, or on the top of the instrument panel.
- Always remove hard, heavy, or sharp objects from clothing and bags in the vehicle interior and stow them securely in the luggage compartment.



## WARNING

Transporting heavy objects causes the handling characteristics of the vehicle to change and increases braking distances. Heavy loads which are not properly stowed or secured in the vehicle can lead to a loss of vehicle control and cause serious personal injury.

- Transporting heavy items causes the handling characteristics of the vehicle to change by shifting the vehicle's center of gravity.
- Always distribute luggage evenly and as low as possible within the vehicle. The vehicle capacity weight figures apply when the load is distributed evenly in the vehicle (passengers and luggage).
- Always stow luggage and heavy items in the luggage compartment as far forward of the rear axle as possible and secure them with appropriate straps to the tie-downs provided.
- Never exceed the vehicle's Gross Vehicle Weight Rating or Gross Axle Weight Ratings, which are printed on the Safety Compliance Certification Label located on the door jamb of the driver door. Exceeding the permissible weight can cause the vehicle to skid and behave differently.
- Always adapt your speed and driving style to accommodate your payload and its weight distribution within your vehicle.
- Be especially cautious and gentle when stepping on the accelerator pedal and avoid sudden braking and other maneuvers.
- Brake earlier than you would if you were not driving a loaded vehicle.



## NOTICE

- The defroster heating wires or antenna in the rear window can be damaged by objects that rub against them.
- The antenna wiring in the side windows can be damaged by items rubbing against it.



The ventilation slots between the rear window and the luggage compartment cover must not be blocked so that stale air can escape from the vehicle.

## Folding the backrest of the rear bench forward and back into place



Fig. 99 Lower part of the rear seat bench: Lever to unlock the rear seat backrest by hand.

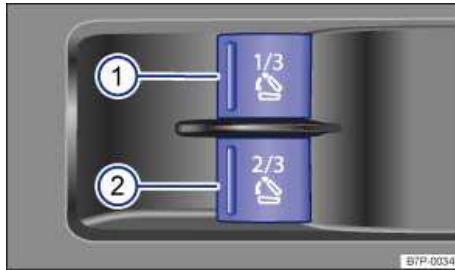

Fig. 100 Right side wall of the luggage compartment: Switches for power release of the rear seat backrest.

**⚠ Please first read and note the introductory information and heed the WARNINGS ⚠**

The rear seat backrest is divided into 2 sections. Each section of the rear seat backrest can be folded down individually to increase luggage space.

There are power release switches for the rear seat backrests in the luggage compartment ⇒ fig. 100.

- (1) Release switch for the *right-hand* backrest section.
- (2) Release switch for the *left-hand* backrest section.

### Folding the rear seat backrest forward

Before folding down the rear seat backrest, push its head restraint(s) all the way down and slide the seat itself backwards as far as it will go ⇒ *Adjusting the seating position*.

- Release the rear seat backrest by hand using the lever underneath the seat or the release switches in the luggage compartment ⇒ fig. 100. The rear seat backrest then folds forward by itself.
- Move the rear seat backrest the rest of the way down by hand and push down on it until it locks into place.
- If the rear backrest is folded down, no one, including children, may ride on the rear seat.

### Folding the rear backrest back into place

- Release the rear seat backrest by hand using the lever underneath the seat or the release switches in the luggage compartment ⇒ fig. 100. The rear seat will unlatch and spring up slightly.
- Fold the rear seat backrest back up and push it securely into its latches, making sure it locks securely into place ⇒ ⚠. The seat release lever must return to its original position.
- The rear backrest must be securely latched into place for the safety belts on the rear seats to provide optimal protection.

- After putting the seat backrest back up, the seat must be adjusted to the person using it ⇒ *Adjusting the seating position.*

### **WARNING**

**Improper folding and improper latching of the rear seat backrest can cause serious personal injury.**

- Always make sure there are no people or animals in the area around the rear seat backrest when folding it forward.
- Never fold the rear backrest up or down while the vehicle is moving.
- When folding the rear seat backrest back up, make sure that the safety belt does not get caught or damaged.
- Keep hands, fingers, feet and other body parts out of the way when folding the rear seat backrest up and down.
- Each rear seat backrest must be securely latched in the upright position so that the safety belts on the rear seats can provide protection. This is particularly the case for the middle seat on the rear bench.
- If a seat is used with an unsecured backrest, the passenger will move forward together with the rear seat backrest during sudden braking, driving maneuvers or a collision.
- No one, including children, may ride on the rear seats if the rear seat backrest is folded down or not correctly latched.

### **NOTICE**

**Before folding the rear seat backrest forward, adjust the front seats so that the rear seat's head restraint or backrest cushion will not butt up against the front seats.**

- The weight on the rear seat backrests when folded down must never exceed 110 lbs. (50 kg).

### **NOTICE**

**Items in the luggage compartment could be damaged or cause damage when the rear seat is adjusted in the fore and aft direction.**

-  If the vehicle battery charge is weak, power release of the rear seat backrests may not be possible.



## Luggage compartment cover

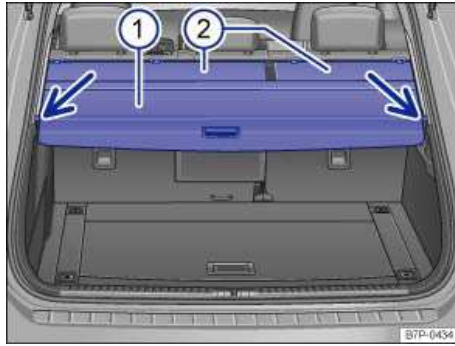

Fig. 101 In the luggage compartment: Closed luggage compartment cover.

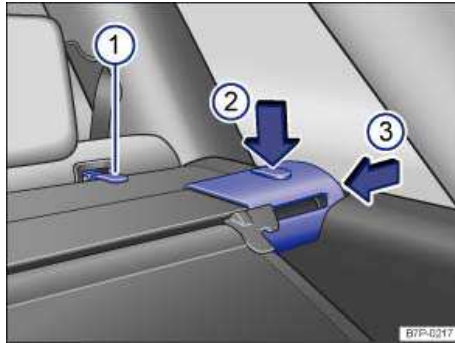

Fig. 102 In the luggage compartment: Removing the luggage compartment cover.

⚠ Please first read and note the introductory information and heed the WARNINGS ⚠

### Opening the luggage compartment cover

- Grasp the luggage compartment cover ⇒ fig. 101 (1) by the handle and pull it slightly to the rear.
- Move the luggage compartment cover down slightly to unhook it from the side retainers (arrows) and then guide it forward to retract it.

### Closing the luggage compartment cover

- Pull the retracted luggage compartment cover (1) evenly towards the rear.
- Hook the luggage compartment cover into the left and right side retainers (arrows).

### Convenience position for the luggage compartment cover

To help make it easier to load the vehicle, the luggage compartment cover can be moved to a higher position.

- With the luggage compartment cover closed, fold up the flap where the handle is located. The luggage compartment cover automatically moves to the convenience position.
- To return the luggage compartment cover to the original position, grasp the handle and pull down evenly. Then hook the luggage compartment cover into the side retainers ⇒ ⚠.

### Removing the luggage compartment cover

- If there is a gap cover (2), unhook it from the fastening eyes on the rear seat backrests ⇒ fig. 102 (1).
- Push down release button (2) and push in the end parts of the luggage compartment cover (3).
- Lift the luggage compartment cover up and out.

### Reinstalling the luggage compartment cover

- First fit the luggage compartment cover ⇒ fig. 101 (1) into the left-hand slot.
- Then fit the other end into the right-hand slot.
- Push down release button ⇒ fig. 102 (2) and push in the end parts of the luggage compartment cover (3).
- Push the luggage compartment cover down into the right-hand slot so that it locks into place.
- Make sure that the luggage compartment cover is properly locked into place.
- If there is a gap cover ⇒ fig. 101 (2), hook it back into the fastening eyes on the rear seat backrests ⇒ fig. 102 (1).



#### WARNING

In a sudden braking or other maneuver, or in a collision, unsecured or improperly secured objects or animals on the luggage compartment cover could cause serious personal injury.

- Never leave hard, heavy or sharp objects in bags or loose on the luggage compartment cover.
- Never let animals ride on the luggage compartment cover.



#### WARNING

The view towards the rear is greatly limited when the luggage compartment cover is in the convenience position.

- Before driving, ensure that the luggage compartment cover is not in the convenience position.



#### NOTICE

To help prevent damage to the luggage compartment cover, the luggage compartment may only be loaded to a height at which the luggage compartment cover will not press on the cargo when the rear hatch is closed.

- The defroster heating wires or antenna in the rear window can be damaged by objects that rub against them.



Do not cover the ventilation slots in the side consoles. Otherwise, stale air cannot escape from the vehicle.

## Luggage compartment pass-through

---

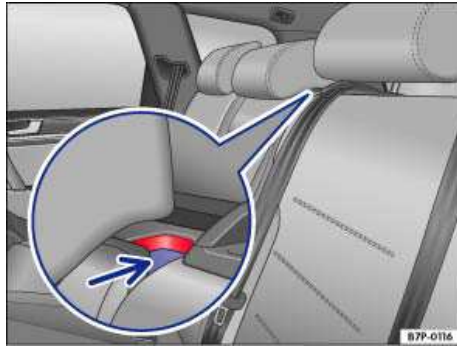

Fig. 103 In the rear backrest: Luggage compartment pass-through opening.

**⚠ Please first read and note the introductory information and heed the WARNINGS ⚠**

There is a pass-through for transporting things like skis in the rear seat backrest behind the center armrest.

To help prevent soiling the vehicle interior, cover dirty items before sliding them into the pass-through.

If the center armrest is folded down, no one can sit on the middle seat of the rear bench.

### Opening the pass-through

- Push the center head restraint all the way down if necessary ⇒ *Adjusting the seating position*.
- Push down the release button (arrow) and fold the center section of the rear seat backrest all the way forward.
- Open the rear hatch.
- Slide long objects from the luggage compartment through the pass-through.
- Secure objects with the safety belt.
- Close the rear hatch.

### Closing the pass-through

- Fold the middle part of the rear seat backrest (pass-through) back up (towards the rear) until it locks in to place. The red mark on the release button should no longer be visible ⇒ [fig. 103](#).
- Close the rear hatch.

**i** The pass-through can also be opened from the luggage compartment. Push down the release button (arrow) and push the center section of the rear seat backrest (pass-through) all the way forward.

## Tie-downs

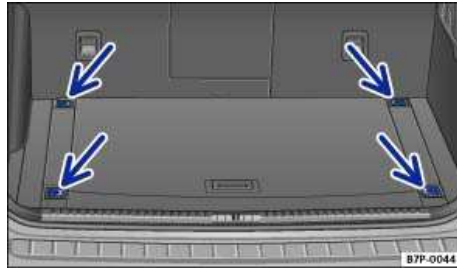

Fig. 104 In the luggage compartment: Tie-downs.

**⚠ Please first read and note the introductory information and heed the WARNINGS ⚠**

There are tie-downs in the front and back of the luggage compartment, which you can use to secure luggage or other items ⇒ fig. 104 (arrows).

You have to fold the tie-downs open to use them.

Elastic straps can snap back towards you if they are not properly attached.

If you use elastic straps to secure items in the luggage compartment, be sure to first securely attach them to the tie-downs just behind the rear seat backrest first and then to the tie-downs at the loading edge of the luggage compartment.

Remove the hooks from the tie-downs in the reverse order described above, first from the tie-downs at the loading edge and then from the tie-downs behind the rear seat backrest so that if the hooks come loose suddenly, they will move away from you.

### **⚠ WARNING**

Unsuitable, worn, or damaged tie-down straps (elastic or non-elastic) can snap or come loose during braking or other maneuvers or in a collision. Objects secured with these straps can then come loose and fly through the passenger compartment, causing severe personal injuries or death.

- To help prevent baggage or other items from coming loose and flying around, always use suitable undamaged tie-down straps.
- Securely fasten the tie-down straps to the tie-downs.
- Loose or improperly secured objects in the luggage compartment can slide about suddenly and change the vehicle's handling.
- Secure even small and light objects. Loose objects in the luggage or passenger compartment can fly about during sudden braking maneuvers or in the event of an accident and injure occupants.
- Never exceed the maximum allowable weight force (kilogram force) when securing objects.
- Never secure a child seat to the tie-downs.

## **⚠ WARNING**

Elastic straps have to be stretched when being attached to the tie-downs in the luggage compartment. Hooks on elastic straps can cause serious personal injury if not handled properly and attached securely.

- Always protect eyes and face from injury from the hooks when attaching them to the vehicle and do not let them snap back and hit you.
- Always hold the hooks on elastic straps firmly when attaching to the vehicle and do not let them snap back and hit you.
- First attach the hooks on the straps to the tie-downs at the rear seat backrest in the luggage compartment and then to the tie-downs near the loading edge of the luggage compartment. This way, if one of the hooks on the elastic straps snaps back, it will move away from you, decreasing the risk of personal injury.

**i** The maximum weight force for the tie-downs is about 785 lbs (356 kg).

**i** For suitable straps and luggage stowage systems, please see an authorized Volkswagen dealer or an authorized Volkswagen Service Facility.

## Shopping bag hook

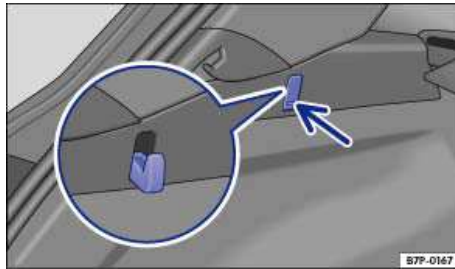

Fig. 105 In the luggage compartment: Shopping bag hook.

**ⓘ** Please first read and note the introductory information and heed the WARNINGS **⚠**

On the left side of the luggage compartment, some vehicles have a pull-down shopping bag hook for hanging light shopping bags.

- Push the bottom of the bag hook (arrow) to fold it out.
- Hang the bag on the hook.

## **⚠ WARNING**

Never use the shopping bag hooks as a tie-downs. The hooks could break off during sudden breaking maneuvers or in a collision.

## **! NOTICE**

The maximum load for the shopping bag hook is 5 lbs (2.5 kg).

## Luggage compartment floor

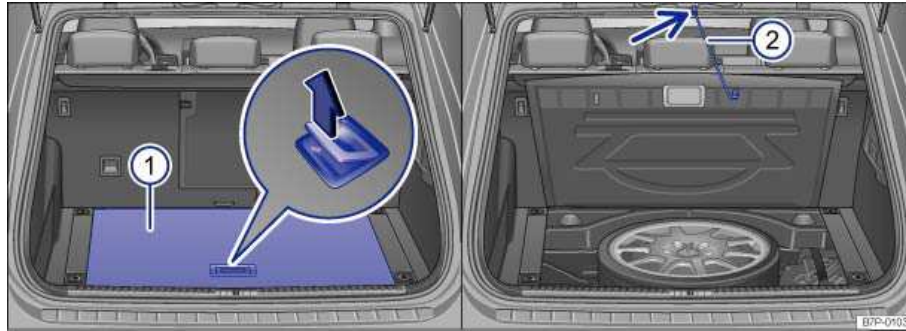

**Fig. 106** In the luggage compartment: Lifting luggage compartment floor panel and securing it with retaining strap.

**⚠ Please first read and note the introductory information and heed the WARNINGS**

Small objects can also be stowed in a compartment **underneath** the luggage compartment floor.

### Opening and securing the luggage compartment floor panel

- Open the rear hatch.
- Open the luggage compartment cover if it is installed ⇒ *Opening the luggage compartment cover*.
- Fold up the luggage compartment floor handle (left magnified view) in the direction of the arrow (1) and lift the floor panel by the handle.
- Hook retaining strap (2) under the luggage compartment floor panel and hang it from the top of the luggage compartment (arrow).

### Unhooking and closing the luggage compartment cover

- Unhook the retaining strap ⇒ [fig. 106 \(2\)](#) from the top of the luggage compartment (arrow).
- Hook the retaining strap (2) underneath the luggage compartment floor panel (1) and lower the floor panel into place.
- Close the luggage compartment cover if you opened it ⇒ *Closing the luggage compartment cover*.
- Close the rear hatch.

### **⚠ WARNING**

During hard braking or an accident, loose objects can fly through the passenger compartment and cause serious or even fatal injuries.

- Even if the luggage compartment floor panel is properly raised, it is still necessary to secure all objects.
- Objects stowed between the rear seat bench and the luggage compartment floor panel must never be more than 2/3 as high as the raised floor panel.
- Objects stowed between the rear seat bench and the raised luggage compartment floor panel must never weigh more than about 16.5 lbs. (7.5 kg).

**i** If you slide the rear seats forward, there is a gap between the luggage compartment floor and the rear seats. Make certain there are no objects in this space before sliding the rear seats back again.

# Roof rack

## Introduction

---

In this section you'll find information about:

Attaching the roof rack base carrier and roof rack  
Securing a load on the roof rack

The roof of your vehicle has been designed to optimize aerodynamics and does not have traditional rain gutters that are used to attach many kinds of roof racks.

Since the rain gutters are molded into the roof to provide efficient aerodynamics, only Volkswagen-approved base carriers and roof racks can be used.

### When should the roof rack be removed?

- When it is no longer needed.
- Before driving through an automatic car wash.
- When the vehicle would otherwise be too high to fit into a space with low clearance, such as a parking garage.

### More information:

- Light
- Transporting
- Tires and wheels
- Saving fuel and helping the environment
- Parts, accessories, repairs and modifications

### WARNING

Transporting heavy or bulky loads on the roof rack will change the way the vehicle handles by shifting the vehicle's center of gravity and increasing the wind drag area.

- Always secure the load properly with suitable and undamaged straps so that the load will not shift.
- Cargo that is large, heavy, bulky, long or flat will have a negative effect on the vehicle's aerodynamics, center of gravity and overall handling.
- Always avoid sudden maneuvers and hard braking.
- Always adapt your speed and driving to the heavier load and the weight distribution in the vehicle. Take road, weather, traffic, and visibility conditions into account as well.

### NOTICE

- Always remove the roof rack before driving through an automatic car wash.
- Your vehicle is higher when the roof rack is installed, especially when it is loaded. Compare the vehicle height with existing clearance heights, such as underpasses and garage doors.
- Always make sure that the roof rack system and anything being carried on it does not interfere with the roof antenna, the power sunroof, or the rear hatch.
- Make sure that the rear hatch does not touch items on the roof rack when opened.



If a roof rack is installed, fuel consumption increases due to increased air resistance.

## Attaching the roof rack base carrier and roof rack

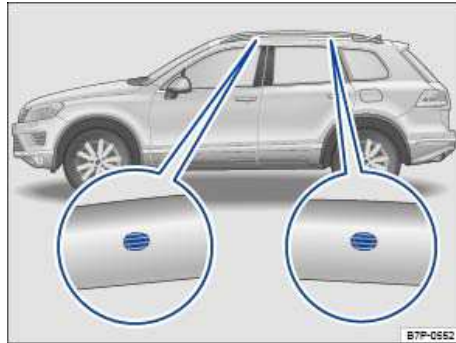

Fig. 107 Attachment points for the base carrier and roof rack.

### **ⓘ Please first read and note the introductory information and heed the WARNINGS ⚠**

The base carrier is the basis of a complete roof rack system. For safety reasons, additional attachments are necessary to transport luggage, bicycles, surfboards, skis and small boats. Suitable accessories can be purchased from your authorized Volkswagen dealer or authorized Volkswagen Service Facility.

No base carrier or roof rack can be installed *unless* the vehicle has roof rails ⇒ [fig. 107](#).

### **Attaching the roof rack base carrier and roof rack**

Always attach the base carrier and roof rack correctly.

Always carefully follow the installation instructions from the base carrier or roof rack manufacturer.

The mounting holes for positioning are on the inside of the roof rails ⇒ [fig. 107](#) (magnified view).

Only mount the roof rack base carrier at the holes shown in the illustration.

### **⚠ WARNING**

**Installing or using a base carrier or roof rack improperly can cause the entire system to fly off the vehicle, causing collision and injury.**

- Always follow the installation instructions provided by the manufacturer.
- Use the base carrier and roof rack only if they are undamaged and properly installed.
- Only mount the roof rack base carrier on the markings shown in the illustration ⇒ [fig. 107](#).
- Install the base carrier and roof rack properly.
- Make sure that all bolts and fasteners are properly installed and properly tightened before every trip; and retighten them as needed after driving a short distance. During a long trip, check all bolts and fasteners at each stop.
- Always properly install special fixtures for items such as bicycles, skis, surfboards, etc.
- Do not modify or repair the base carrier or roof rack.

**ⓘ** Follow the installation instructions provided for installing the roof rack system. Always carry them in the vehicle.



## Securing a load on the roof rack

 Please first read and note the introductory information and heed the WARNINGS 

It is not possible to secure a load unless the roof rack system has been properly installed ⇒ 

### Maximum permissible roof load

The maximum permissible roof load is **220 lbs. (100 kg)**. The maximum permissible roof load is the combined weight of the roof rack and the items being carried on the roof ⇒ 

Be sure you know the weight of the roof rack and the items you want to transport on the roof. Weigh them if necessary. Never carry a total of more than the maximum permissible roof load.

When using a roof rack with a low load limit, do not load the rack to the maximum weight mentioned above. In this case, you may only load the roof rack to the weight limit specified in the system's installation instructions.

### Distributing the load

Distribute the load evenly and secure it properly ⇒ 

### Checking the mountings

After the base carrier and roof rack have been installed, check all bolts and fasteners after driving a short time and at regular intervals thereafter.

#### WARNING

If the maximum permissible roof load is exceeded, accidents and substantial vehicle damage may occur.

- Never exceed the specified roof load, the maximum gross axle weight rating, or the gross vehicle weight rating.
- Do not exceed the loading capacity of the roof rack, even if the permissible roof load is not fully utilized.
- Always make sure that loads are properly distributed and that heavier items are as far as possible, toward the front.

#### WARNING

Loose or improperly secured items can fall off the roof rack and cause accidents and injuries.

- To help prevent baggage or other items from coming loose and flying around, always use suitable undamaged tie-down ropes and ratchet straps.
- Secure the load properly.

## Trailer towing

### Introduction

---

In this section you'll find information about:

Technical requirements  
Hitching up and connecting a trailer  
Loading the trailer  
Driving with a trailer  
Ball mount  
Retrofitting a trailer hitch  
Maximum permissible trailer weight

Obey country-specific requirements about trailer towing and trailer hitches.

Your Volkswagen was mainly designed for carrying passengers. If you plan to tow a trailer, please remember your vehicle will be performing a job for which it was not primarily intended. The additional load will affect durability, handling, fuel economy, and performance, and may require the vehicle to be serviced more often.

Trailer towing not only places more stress on the vehicle, it calls for more concentration from the driver. Always follow the operating and driving instructions given, and use common sense.

Under winter conditions, install winter tires on the vehicle **and** the trailer.

#### **Tongue weight**

The *maximum* permissible trailer tongue weight exerted on the ball mount must not exceed **616 lbs (280 kg)**.

#### **More information:**

- Power locking and closing system
- Anti-theft alarm system
- Lights
- Tires and wheels
- Braking and parking
- Saving fuel and helping the environment
- Starting assistance systems
- Parts, accessories, repairs and modifications



#### **WARNING**

**Riding in a trailer is dangerous and may be illegal.**

 **WARNING**

Improper use of the trailer hitch can cause accidents and injuries. An improperly installed, incorrect, or damaged trailer hitch can cause the trailer to separate from the towing vehicle and cause serious personal injuries.

- Only use an undamaged, properly mounted trailer hitch.
- Never repair or modify the trailer hitch.
- To reduce the risk of injury in rear-end collisions, and the risk to pedestrians and cyclists when the vehicle is parked, always remove the ball mount when you are not towing a trailer.
- Never install a “weight distributing” or “load equalizing” trailer hitch on your vehicle. The vehicle was not designed for these kinds of trailer hitches. The trailer hitch attachment can fail, causing the trailer to tear loose from the vehicle.

 **WARNING**

Improper trailer towing can cause loss of vehicle control and serious personal injury.

- Driving with a trailer and carrying heavy or large things can change the way the vehicle handles, increase the distance it needs to stop safely, and cause accidents.
- Always secure the load properly with suitable and undamaged straps so that the load will not shift.
- Always adapt your speed and driving to the heavier load and the weight distribution in the vehicle. Take road, weather, traffic, and visibility conditions into account as well.
- Reduce your speed even more than you otherwise would when going downhill and under unfavorable load, weather, or wind conditions.
- Trailers with a high center of gravity tip more easily than trailers with a low center of gravity.
- Always avoid sudden maneuvers and hard braking.
- Be especially careful when passing other vehicles.
- Reduce speed immediately if the trailer shows the slightest sign of swaying.
- Never try to stop the swaying by accelerating.
- Always obey speed limits. In some areas, the speed limits for vehicles towing trailers are lower than for vehicles without trailers. Never drive faster than 50 mph - 80 km/h (under exceptional circumstances 60 mph - 100 km/h) when towing a trailer. This applies even if the local speed limit is higher.

 If you are driving a new vehicle or a vehicle with a new or rebuilt engine, do not tow a trailer during the break-in period, about 600 miles (1,000 km) ⇒ *Parts, accessories, repairs and modifications*.

 If you tow a trailer, your vehicle may need maintenance more often because of the extra load it has to move.

 When you are not towing, remove the trailer hitch ball. This helps keep the trailer hitch from causing damage to your vehicle and to others if your vehicle is hit from behind.

 Some models need a trailer hitch to tow or tow-start other vehicles. You may want to always carry the ball mount in the vehicle after it has been removed. Be sure to stow it securely.

## Technical requirements

### ⚠ Please first read and note the introductory information and heed the WARNINGS ⚠

Use only a weight-carrying trailer hitch designed and approved for the gross weight of the trailer you want to tow. The trailer hitch must be suitable for your vehicle and trailer and must be securely bolted to the appropriate place on the vehicle chassis. Use only a trailer hitch with a removable ball mount. Always check with the trailer hitch manufacturer to make sure that you are using the correct trailer hitch and carefully follow the hitch manufacturer's instructions. Never install a "weight distributing" or "load equalizing" trailer hitch on your vehicle. The vehicle is not designed for this kind of trailer hitch



Your authorized Volkswagen dealer or authorized Volkswagen Service Facility has the genuine Volkswagen hitch receiver, ball mount and electrical kit that has been specifically approved for your vehicle.

### Do not use a bumper-mounted trailer hitch

Never install a trailer hitch on the bumper or on the bumper attachments. The trailer hitch must not interfere with the impact-absorbing bumper system. Do not make any changes to the vehicle exhaust and brake systems. From time to time, check that all trailer hitch mounting bolts are securely fastened. When you are not towing, remove the trailer hitch. This helps keep the trailer hitch from causing damage if your vehicle is hit from behind.

### Engine cooling system

Towing a trailer makes the engine and its cooling system work harder. It is important that the engine cooling system is up to the job. Make sure that the cooling system has enough coolant.

### Trailer brakes

If your trailer has its own brakes, make sure it meets all regulations. The trailer brake system must never be directly connected to the vehicle's brake system.

### Safety chains

Always use safety chains between your vehicle and the trailer ⇒ *Hitching up and connecting a trailer.*

### Trailer taillights

Trailer lights must meet all regulations ⇒ *Hitching up and connecting a trailer.*

Never connect the trailer lights directly to the electrical system of your vehicle. Be sure to check with your authorized Volkswagen dealer or authorized Volkswagen Service Facility about correct wiring, switches and relays.

### Outside mirrors

If you cannot see the traffic behind you using the regular outside mirrors, then you must install extended mirrors. Extended mirrors may also be required by law in some countries/states/provinces. Always adjust the outside mirrors before driving. It's vital that you always have a clear view to the rear of the vehicle.

### Maximum power consumption for the trailer

Do not exceed the power ratings listed in the chart below.

Electrical load	Maximum power
Brake lights total	108 watts

Electrical load	Maximum power
Turn signals per side	54 watts
Side marker lights total	100 watts
Taillights total	54 watts

### WARNING

- An improperly installed or incorrect trailer hitch can cause a trailer to separate from the tow vehicle and cause serious personal injuries.
- If you don't have to tow a trailer any more, remove the entire trailer hitch. Always seal all bolt holes to prevent water and deadly exhaust fumes from getting into the vehicle.

### NOTICE

- If the trailer lights are not connected properly, the vehicle's electronics may be damaged.
- If the trailer uses too much electricity, the vehicle's electronics may be damaged.
- Never connect the electrical system for the trailer directly to the electrical connections for the rear lights or to any other unsuitable power sources. Use only a suitable connector to provide power to the trailer.

 If you tow a trailer frequently, Volkswagen recommends having the vehicle serviced between the regular maintenance and inspection intervals because of the extra load it has to pull.

 In some countries an additional fire extinguisher must be carried if the total weight of the trailer exceeds 5,512 lbs (2,500 kg).

## Hitching up and connecting a trailer

 Please first read and note the introductory information and heed the WARNINGS 

### Safety chains

Always make sure that the safety chains are properly attached to the towing vehicle. Leave enough slack in the chains so that you can go around corners without stretching the chains. The safety chains must not drag on the ground, however.

### Trailer electrical socket

The vehicle is equipped with a setup for connecting a trailer socket. The electrical connection between the towing vehicle and the trailer is a conventional 7 pin trailer socket.

### Trailer taillights

Make sure that the trailer lights work properly and meet legal requirements. Do not exceed the maximum power consumption for the trailer ⇒ *Maximum power consumption for the trailer.*

### The trailer is connected to the anti-theft alarm (if equipped):

- When the vehicle has a factory installed anti-theft alarm and a factory installed trailer hitch.
- When the trailer is not equipped with LED taillights.
- When the trailer is electrically connected to the towing vehicle via the trailer socket.
- When the vehicle and trailer electric systems are functional, fault-free and undamaged.
- When the vehicle is locked with the remote control vehicle key and the anti-theft alarm is active.

When the vehicle is locked, the alarm will be triggered as soon as the electrical connection to the trailer is interrupted.

Always switch off the anti-theft alarm when a trailer is being hitched or unhitched. The tilt sensor could otherwise trigger an alarm unnecessarily.



### WARNING

Improper connections to the vehicle electrical system can cause malfunctions that affect the entire vehicle electrical system, which can lead to accidents and serious personal injury.

- Have any work on the electrical system done by an authorized Volkswagen dealer or authorized Volkswagen Service Facility.
- Never connect the electrical system for the trailer directly to the electrical connections for the rear lights or to any other unsuitable power sources. Use only a suitable connector to provide power to the trailer.



### NOTICE

Never attach a trailer to the vehicle or leave it attached to the vehicle when the trailer is supported by a trailer jack or blocks. Various things (such as a change in trailer or vehicle load or a flat tire) can lower or raise the vehicle. This subjects the trailer hitch and the trailer to strong forces that can damage the vehicle or the trailer.



Any problems with the vehicle's electrical system when attached to a trailer should be checked by an authorized Volkswagen dealer or authorized Volkswagen Service Facility.



If the engine is switched off and accessories in the trailer are on and use electricity from the vehicle, the vehicle battery will be drained as long as the electrical systems of the vehicle and the trailer are connected.



For technical reasons, trailers with LED taillights cannot be integrated into the anti-theft alarm system.

## Loading the trailer

---

 Please first read and note the introductory information and heed the WARNINGS 

### Maximum permissible trailer weight and tongue weight

Maximum permissible trailer weight is the load that the vehicle can tow ⇒ . The tongue load or tongue weight is the load pressing down on the trailer hitch ball mount

The maximum permissible trailer weight and tongue weight for your vehicle are listed on ⇒ *Maximum permissible trailer weight* in this Manual.

The trailer load and tongue weight on the type identification plate for the trailer hitch are only test values. The vehicle-specific figures are often *lower than* these values. In some countries, but generally not in the United States, the vehicle-specific figures are listed in the official vehicle documents. Specifications in official vehicle documents always take precedence.

To help ensure optimum handling and driving safety, Volkswagen recommends always using the maximum permissible **tongue weight**. If the tongue weight is too low, the vehicle and trailer will not handle as well.

Tongue weight increases the load on the rear axle and, in turn, reduces the remaining load your vehicle can carry ⇒ *Determining the correct load limit*.

### Combined towing weight

Combined towing weight is the weight of the loaded towing vehicle plus the weight of the loaded trailer.

This vehicle has not been designed to tow a Class III trailer and must never be retrofitted to tow a Class III trailer. Always make sure that your vehicle has been designed to tow the trailer you want to use and that is legal to tow the trailer where you will be driving.

### Loading the trailer

The weight distribution in the vehicle and trailer must be balanced. Use the maximum permissible tongue weight and make sure that the load in the trailer is evenly distributed and that it is not front-heavy or tail-heavy:

- Distribute the load in the trailer so that heavy objects are directly above the axle or as close as possible to the axle.
- Secure loads properly on the trailer.

### Tire pressure

Always follow the trailer manufacturer's tire pressure recommendations for the trailer tires.

When towing, inflate the towing vehicle's tires to the maximum permissible pressure listed on the tire pressure label ⇒ *Tires and wheels*.

### WARNING

**Exceeding the gross weight ratings for axle, tongue, vehicle, trailer or combined weight can cause accidents and serious personal injury.**

- **Never exceed the specified values.**
- **Never let the actual weights at the front and rear axles exceed the Gross Axle Weight Ratings. Never let the combined front and rear weights exceed the Gross Vehicle Weight Rating.**

### WARNING

**Trailer loads that are not properly secured can shift when the vehicle is moving or braking and suddenly change the way the vehicle handles, causing accidents and severe injuries.**

- **Always load the trailer properly.**
- **Always secure the load properly with suitable, undamaged straps that can be tightened so that the load cannot shift.**

## Driving with a trailer

 Please first read and note the introductory information and heed the WARNINGS 

### Headlight settings

Towing a trailer can raise the front end of the vehicle enough for the low beams to blind other road users. Use the headlight range adjustment feature to lower the light cones as required. If your vehicle does not have headlight range adjustment, have the headlights adjusted by an authorized Volkswagen dealer or authorized Volkswagen Service Facility. Vehicles with Xenon headlights self-adjust to vehicle load and do not need manual adjustment.



### Special towing considerations

- If the trailer has an **overrun brake**, apply the brakes *gently at first* and then firmly. This helps to prevent sudden brake shock and helps prevent trailer wheels from locking up.
- Due to the combined towing weight including the higher gross vehicle weight, the stopping distance is longer.
- Before driving downhill, especially on hills that are long or steep, shift into a lower gear so that the engine helps to brake the vehicle. Otherwise, the brake system could overheat and might fail.
- The vehicle's center of gravity and, in turn, the vehicle's handling, will change because of the trailer load and the increased combined towing weight of the vehicle and trailer.
- Weight distribution is especially bad if the towing vehicle is empty and the trailer is loaded. If you absolutely must drive with this combination, drive with extra care and at a reduced speed.

### Starting off with a trailer on hills

Depending on how steep the hill is and the combined towing weight, a parked vehicle with trailer can roll backwards when you first start moving.

When starting off with a trailer on a hill:

- Depress and hold the brake pedal.
- Put the transmission in Drive (**D**).
- Press the  button once to deactivate the electronic parking brake ⇒ page 411, *Braking and parking*.
- Pull and hold the  button to hold the vehicle and trailer with the electronic parking brake ⇒ *Braking and parking*.
- At the same time, release the brake pedal and gradually depress the accelerator. Do not release the  button until the engine starts to move the vehicle forward. If your vehicle has an automatic transmission, you can also depress and hold the brake pedal for added braking and then let up on the brake pedal when you feel that the vehicle “wants” to move forward.
- Drive ahead slowly.



## **⚠ WARNING**

Improper trailer towing can cause loss of vehicle control and serious personal injury.

- Driving with a trailer and carrying heavy or bulky items changes the way the vehicle handles and increases the distance it needs to stop safely.
- Always watch what is happening up ahead and around you. Brake earlier than you would if you were not towing a trailer.
- Always adapt your speed and driving to the heavier load and the weight distribution in the vehicle. Take road, weather, traffic, and visibility conditions into account as well.
- Reduce your speed even more than you otherwise would when going downhill and under unfavorable load, weather, or wind conditions.
- Drive especially carefully and accelerate gently. Always avoid sudden maneuvers and hard braking.
- Be especially careful when passing other vehicles.
- Reduce speed immediately if the trailer shows even the slightest sign of swaying.
- Never try to stop the swaying by accelerating.
- Always obey speed limits. In some areas speed limits for vehicles towing trailers are lower than for vehicles without trailers.

## Ball mount

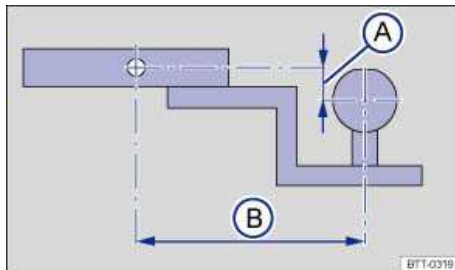

Fig. 108 Dimensions of the ball mount support.

**⚠ Please first read and note the introductory information and heed the WARNINGS**

If you must tow a trailer, you must have the necessary electrical wiring and socket together with a suitable trailer hitch installed. Because towing a trailer places a great deal of stress on the vehicle, the attachment of a trailer to the vehicle and the dimensions of the receiver and ball mount are very important so that the extra forces the vehicle has to withstand can be properly handled.

Depending on its equipment, certain parts required for the installation of a trailer hitch may already have been installed at the factory. If your vehicle does not already have the preparation package installed, your authorized Volkswagen dealer or authorized Volkswagen Service Facility can install the necessary parts and equipment including the proper trailer hitch for you.

The receiver used requires both a ball mount and a ball that meet special requirements regarding geometry and size. This applies to both the height of the ball above the surface where it attaches ⇒ fig. 108 (A), and the pin-to-ball distance (B).

These dimensions are important because they help determine the way that the forces that arise during towing are applied to the receiver and its attachments to the vehicle. If you buy a different ball mount and ball, make sure that they meet the following specifications.

### Ball mount dimensions

- The drop height (A) from the center of the ball to the center of the hole for the securing pin on the ball mount must be at least  $1\frac{1}{4}$  inches (32.3 mm) and at most  $2\frac{7}{8}$  inches (73 mm).
- The pin-to-ball distance (B) from the center of the ball to the center of the hole for the securing pin on the ball mount must be no more than  $6\frac{1}{8}$  inches (157.3 mm).
- The ball diameter must be no more than 2 inches (51 mm).

Volkswagen recommends that you have an authorized Volkswagen dealer or an authorized Volkswagen Service Facility install the electrical system and socket.

A ball mount and ball combination that does not meet these specifications can damage your vehicle and may even fail in use ⇒ .

Never install a “weight distributing” or “load equalizing” trailer hitch on your vehicle. The vehicle is not designed for this kind of trailer hitch ⇒ .

### WARNING

An improperly installed or unsuitable trailer hitch can cause the trailer to separate from the towing vehicle and result in a major accident with serious personal injuries.

- Have any trailer hitch retrofit or other work on a trailer hitch done by a qualified workshop.

### CAUTION

The ball mount sticks out behind the rear bumper and can cause injury to pedestrians and cyclists.

- To reduce the risk of injury in rear-end collisions, and the risk to pedestrians and cyclists when the vehicle is parked, always remove the ball carrier when you are not towing a trailer.

### NOTICE

- Never use a ball larger than 2 inches (51 mm) on your vehicle. The vehicle was not designed to tow heavier trailers with a receiver larger than the specified ball. The increased loads can damage the attachment points for the trailer hitch.
- Never use an adapter to increase the size of the trailer hitch receiver to more than 2 inches (50.8 mm) to tow a trailer that is heavier than the maximum permissible trailer weight that your vehicle can tow.
- You can use an adapter if required for the proper installation of a bicycle rack or other similar carrier as long as the maximum weight limits are observed. When using bicycle racks or similar carriers make sure that the rear lights are not blocked.
- Only use trailer hitches that are approved by the hitch manufacturer for your vehicle and model.

## Retrofitting a trailer hitch

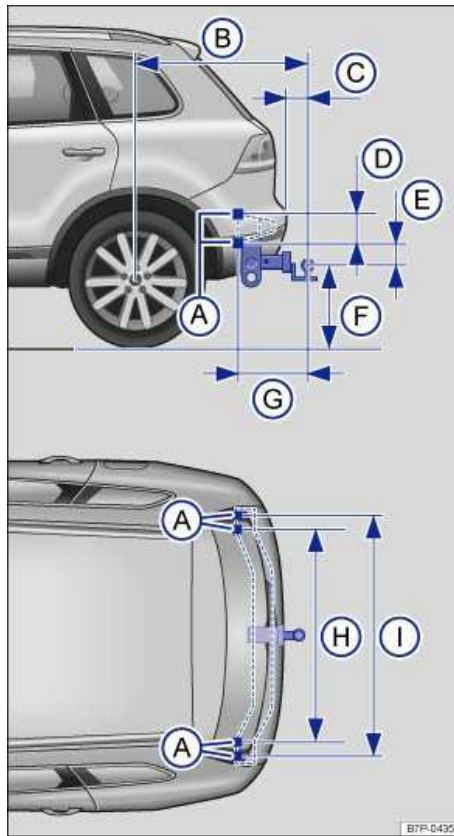

**Fig. 109** Dimensions and attachment points for retrofitting a trailer hitch.

**⚠ Please first read and note the introductory information and heed the WARNINGS ⚠ on page 163.**

Volkswagen recommends having the trailer hitch retrofit performed by a qualified workshop because cooling system modifications or the installation of heat shields may be necessary. Volkswagen recommends that you see an authorized Volkswagen dealer or an authorized Volkswagen Service Facility before having a hitch installed on your vehicle.

When retrofitting a trailer hitch, the specified distance dimensions must be strictly adhered to. Under no circumstances may the distance from the center of the hitch ball to the surface of the road

⇒ [fig. 109 \(F\)](#) be less than the specified minimum. This minimum height must be present even when the vehicle is fully loaded and subject to the maximum tongue weight.

**Distance dimensions** ⇒ [fig. 109](#):

- (A) Attachment points.
- (B)  $42\frac{5}{16}$  inches (1074.6 mm)
- (C) at least  $2\frac{9}{16}$  inches (65 mm)
- (D)  $5\frac{1}{8}$  inches (131 mm)

- (E) 2<sup>1</sup>/<sub>16</sub> inches (52 mm)
- (F) from 13<sup>3</sup>/<sub>4</sub> inches to 16<sup>1</sup>/<sub>2</sub> inches (350 - 420 mm)
- (G) 13<sup>15</sup>/<sub>16</sub> inches (354.5 mm)
- (H) 41<sup>5</sup>/<sub>16</sub> inches (1050 mm)
- (I) 46<sup>7</sup>/<sub>16</sub> inches (1180 mm)

**⚠ WARNING**

Improper or incorrect connections to the vehicle electrical system can cause malfunctions that affect the entire vehicle electrical system and cause accidents and serious personal injury.

- Never connect the electrical system of the trailer directly to the electrical connections of the rear lights or other unsuitable power sources. Use only a suitable connector to provide power to the trailer.
- Have any trailer hitch retrofit or other work on a trailer hitch done by a qualified workshop.

**⚠ WARNING**

An improperly installed or unsuitable trailer hitch can cause the trailer to separate from the towing vehicle and result in a major accident with serious personal injuries.

**i** Only use trailer hitches that are approved by Volkswagen for your vehicle and model.

### Maximum permissible trailer weight

**ⓘ** Please first read and note the introductory information and heed the **WARNINGS** **⚠**

Maximum permissible trailer weights	lbs.	kg
Trailer with brakes	7716	3500
Trailer without brakes	1650	748
Trailer hitch tongue load	617	280

The Gross Vehicle Weight Rating and the Gross Axle Weight Rating must not be exceeded, even with a trailer. These ratings are listed on the safety compliance label on the left front door jamb ⇒ *Important vehicle labels*. When a trailer is towed, the weight of the ball mount and the tongue weight of the trailer are added to the vehicle weight ⇒ *Determining the correct load limit*.

The trailer weight ratings given above are valid only up to altitudes of 3000 ft (1000 m) above sea level. The maximum permissible combined towing weight must be reduced by about 10% for every 3000 ft (1000 m), or portion thereof, of additional altitude.

 **WARNING**

Exceeding the gross trailer weight rating and tongue weight can cause accidents and serious personal injury.

- Never let the actual weights at the front and rear axles exceed the Gross Axle Weight Ratings. Never let the combined front and rear weights exceed the Gross Vehicle Weight Rating.

 **NOTICE**

Exceeding the gross weight ratings can cause extensive vehicle damage that is not covered by any Volkswagen Limited Warranty.

# Tires and wheels

## Introduction

---

In this section you'll find information about:

Tire and wheel handling  
Wheel rims  
New and replacement tires  
Tire inflation pressure  
Tire inflation pressure in cold tires  
Tread depth and tread wear indicators  
Tire wear and damage  
Collapsible spare tire  
Tire labeling  
Winter tires  
Snow chains  
Glossary of tire and loading terminology  
Tires and vehicle load limits  
Determining the correct load limit  
UTQG classification

Volkswagen recommends that all work on tires and wheels be done by an authorized Volkswagen dealer or authorized Volkswagen Service Facility. They are familiar with the technical requirements and recommended procedures, have the necessary special tools and spare parts, and can properly dispose of old tires.

### **More information:**

- Transporting
- Trailer towing
- Tire Pressure Monitoring System (TPMS)
- Braking and parking
- Exterior care and cleaning
- Consumer information
- Vehicle tool kit
- Wheel covers
- Changing a wheel
- Tire mobility set

 **WARNING**

New tires or tires that are old, worn or damaged cannot provide maximum control and braking performance.

- Improper care and handling of tires and wheels can reduce driving safety and cause accidents and severe injuries.
- Install only radial tires of the same make, the same dimensions (tread circumference), and similar tread profile on all 4 wheels.
- New tires tend to be slippery and must be broken in. Always drive with special care for the first 350 miles (560 km) to help reduce the risk of losing control, a collision, and serious personal injuries.
- Check tire inflation pressure regularly when the tires are cold and always maintain the prescribed tire pressure. Low tire pressure can cause tires to get too hot, resulting in tread separation, sudden loss of pressure, and blowouts. Tires with excessively low pressure flex (bend) more, which can cause the tire to overheat and fail suddenly without warning.
- Check tires regularly for wear and damage.
- Never drive with worn or damaged tires (for example, tires with punctures, cuts, cracks, blisters, or bumps). Driving with worn or damaged tires can lead to loss of vehicle control, sudden tire failure including blowouts and sudden deflation, crashes, and serious personal injuries.
- Have worn or damaged tires replaced immediately.
- Never exceed the maximum speed rating or the maximum load rating of the tires on your vehicle.
- The effectiveness of the driver assistance systems and the braking support systems depends on the tire traction.
- If you notice unusual vibration or if the vehicle pulls to one side when driving, always stop as soon as it is safe to do so and check the wheels and tires for damage.
- To reduce the risk of losing control, crashes, and serious personal injuries, never loosen the bolts on wheels with bolted rim rings.
- Never mount used tires on your vehicle if you are not sure of their past use. Old, used tires and wheels may have damage that cannot be seen that can lead to sudden tire failure and loss of vehicle control.
- Tires age even if they are not being used and can fail suddenly, especially at high speeds, causing loss of vehicle control, accidents, and severe personal injuries. Tires that are more than 6 years old can be used only in an emergency and even then only with special care and at low speed.

 For technical reasons it is usually not possible to use wheel rims from other vehicles. Even wheel rims from the same model may not fit properly. Check with an authorized Volkswagen dealer or authorized Volkswagen Service Facility if necessary.

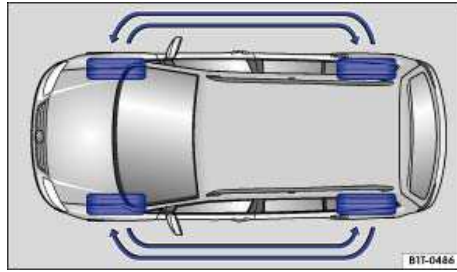

Fig. 110 Tire rotation diagram.

**⚠ Please first read and note the introductory information and heed the WARNINGS ⚠**

Tires may be the least appreciated and most abused parts of a motor vehicle. Tires are very important, since their small patches of rubber are the only contact between your vehicle and the road.

Maintaining correct tire pressure, making sure that your vehicle and its tires do not have to carry more weight than they can safely handle, and regularly inspecting tires for damage (such as cuts, slashes, irregular wear, and overall condition) are the most important things that you can do to help avoid sudden tire failure, including tread separation and blowout.

The tires and wheels are essential parts of the vehicle's design. The tires and wheels approved by Volkswagen are specially matched to the characteristics of the vehicle for good road holding and safe handling when in good condition and properly inflated.

### Avoiding tire damage

- If you must drive over a curb or other obstacle, drive very slowly and as much as possible at a right angle to the curb with the tire tread of both front wheels contacting the curb at the same time.
- Regularly check tires for damage, such as punctures, cuts, tears and blisters.
- Remove embedded material in the tread profile that **has not yet penetrated the inside of the tire** ⇒ *Tire wear and damage*.
- Heed all warning messages from the Tire Pressure Monitoring System (TPMS)
- Replace worn or damaged tires immediately ⇒ *Tire wear and damage*.
- Damage to tires and wheels is often not readily visible. If you notice unusual vibration or the vehicle pulls to one side, this may indicate that one of the tires is damaged. The tires must be checked immediately for **hidden damage** by an authorized Volkswagen dealer or an authorized Volkswagen Service Facility. See also ⇒ *Tire wear and damage*.
- Never exceed the load and permissible maximum speed rating of the tires ⇒ *Tire labeling*.
- Always keep aggressive chemicals including grease, oil, gasoline and brake fluid off the tires, including the compact spare tire ⇒ ⚠.
- Replace missing valve caps immediately.

### Unidirectional tires

Unidirectional tires are designed to rotate only in one direction. Unidirectional tires have arrows on the sidewalls that show the direction of rotation ⇒ *Tire labeling*. Unidirectional tires must always be mounted according to the specified direction of rotation in order to deliver their best grip, braking performance, low road noise, and good wear as well as good hydroplaning resistance.

If you have to mount a tire opposite to its proper direction of rotation, you must drive more carefully, since the tire is no longer being used as designed. This is particularly important on wet roads. You



must replace or remount the tire as soon as possible in order to restore the correct direction of rotation.

### Rotating tires

To help ensure even wear on all tires, regular tire rotation according to the diagram ⇒ [fig. 110](#) is recommended. In this way all tires can have about the same service life.

Volkswagen recommends that you have your tires rotated by an authorized Volkswagen dealer or authorized Volkswagen Service Facility.

### Tires more than 6 years old

Tires age even if they are not being used. Physical and chemical processes reduce tire strength and performance and cause them to harden and become brittle. Old tires can fail suddenly and without warning.

Volkswagen recommends replacing tires that are 6 years and older. This also applies to tires that look new (including the tire on the compact spare wheel) or that seem to still be usable with tread depth that has not yet reached the legal minimum depth ⇒ .

The age of each tire can be determined with the manufacturing date that is part of the U.S. DOT tire identification number (TIN) ⇒ *Tire labeling*.

### Tire storage

Mark tires before removing them to help make sure that the previous location (left, right, front, rear) and rolling direction can be maintained when remounting them. Store tires in a cool, dry and preferably dark place. Do **not** store tires mounted on wheels standing up.

Tires not mounted on wheels should be covered to help protect them from dirt and stored vertically (sitting on the tread).

 **WARNING**

**Aggressive fluids and materials can cause visible and invisible tire damage that can cause tire blowouts.**

- Always keep chemicals, oils, grease, fuels, braking fluids and other aggressive substances away from tires.

 **WARNING**

**Tires age even if they are not being used and can fail suddenly, especially at high speeds, causing loss of vehicle control, accidents, and severe personal injuries.**

- Tires that are more than 6 years old can be used only in an emergency and even then only with special care and at low speed.

 Always dispose of old tires in accordance with legal requirements.

## Wheel rims

---

 Please first read and note the introductory information and heed the **WARNINGS** 

The design of wheel bolts is matched to the factory-installed wheels. If different wheels are installed, wheel bolts with the right length and bolt head shape must be used. This helps to ensure that wheels can be mounted securely and that the brakes will work correctly.

In most cases, you cannot use wheel bolts from a different vehicle. Even wheel rims from the same model may not fit properly.

Tires and wheel rims approved by Volkswagen have been matched precisely to your vehicle model and contribute considerably to good handling and safe vehicle performance.

### Tightening Torque

Wheel bolts must always be installed with the correct tightening torque ⇒ *Changing a wheel*. The required tightening torque for the Touareg's wheel bolts is **133 ft-lbs (180 Nm)**. After changing a wheel, the bolt torque must be checked as soon as possible with an accurate torque wrench. See an authorized Volkswagen dealer or authorized Volkswagen Service Facility.

### Wheel rims with bolted rim rings

Wheel rims with bolted rim rings have several parts. The parts are bolted together with special screws in a special process. This helps to ensure that they will work properly, prevent leaks, run true and safely. Damaged wheel rims must be replaced, and you must never take them apart or try to repair them yourself. Have an authorized Volkswagen dealer or an authorized Volkswagen Service Facility repair them for you ⇒ ⚠.

### Wheel rims with bolted decorative covers

Light-alloy wheels may have interchangeable decorative covers attached to the rim with self-locking screws. If you want to replace damaged wheel covers, contact your authorized Volkswagen dealer or authorized Volkswagen Service Facility ⇒ ⚠.

 <b>WARNING</b>
Using improper or damaged wheel rims can affect driving safety, cause accidents and severe personal injuries.
<ul style="list-style-type: none"><li>• Use only wheel rims approved for the vehicle.</li><li>• Regularly check wheel rims for damage and replace them if necessary.</li></ul>

 <b>WARNING</b>
Improper loosening and tightening of the bolts on wheel rims with bolted rim rings can cause accidents and severe personal injury.
<ul style="list-style-type: none"><li>• Never loosen bolted connections on wheel rims with bolted rim rings.</li><li>• Have all work on wheel rims with bolted rim rings performed by an authorized Volkswagen dealer or authorized Volkswagen Service Facility.</li></ul>

## New and replacement tires

---

📖 Please first read and note the introductory information and heed the WARNINGS ⚠

### New tires

- Drive a vehicle with new tires especially carefully for the first 350 miles (560 km) because the tires must first be *broken in*. Tires that are not broken in have reduced traction ⇒ ⚠ and braking performance ⇒ ⚠.
- Install only radial tires only of the same make, the same dimensions (tread circumference), and similar tread profile on all 4 wheels.

- The tread depth of new tires can differ between tire models and manufacturers because of different design features and tread design.

### Replacing tires

- Tires should be replaced in pairs and not individually (both front tires or both rear tires at the same time) ⇒ ⚠.
- Replace tires only with tires that have the same specifications, including width and diameter, load and top speed rating as the tires approved by Volkswagen for your vehicle and model.
- Never use tires that are larger or wider than the dimensions of the tires approved by Volkswagen for your vehicle and model. Larger tires could scrape and rub on the vehicle body or other parts of the vehicle.

### Tire Pressure Monitoring System (TPMS) considerations

Factory-installed wheels are equipped with a sensor that constantly monitors tire pressure, then transmits this information to the TPMS ⇒ *Tire Pressure Monitoring System (TPMS)*. If you are going to replace the wheels, make sure that the new wheels also have sensors that are compatible with the TPMS on your vehicle. New wheels with sensors have to be recognized and integrated into the system. The new wheels and sensors are recognized and integrated when driving off the first time.

If you install wheels that do not have sensors, or have sensors that are not compatible, the TPMS will not work properly. In this case, the TPMS will not be able to monitor tire pressure or warn you if pressure is low. An error message may appear in the instrument cluster display or the TPMS will switch itself off.

- Whenever you change sensors, you have to install new valves and seals. Please see an authorized Volkswagen dealer or an authorized Volkswagen Service Facility.
- Always drive with the valve caps securely installed. We recommend using factory-supplied valve caps. Ask an authorized Volkswagen dealer or an authorized Volkswagen Service Facility to replace lost caps.

If you install new tires that differ the original Volkswagen specifications, for your vehicle and model, the benchmark tire inflation pressure values stored in your vehicle's TPMS may have to be adjusted (reprogrammed). This requires professional assistance. For more information, contact your authorized Volkswagen dealer or authorized Volkswagen Service Facility.

Installing replacement tires with steel cord body plies in the tire sidewall may cause malfunction of the TPMS, and is not recommended (cord material information is molded on the tire sidewall).

Always check the TPMS indicator light after replacing one or more tires on your vehicle. If the indicator light is on, the TPMS is not working properly. Your replacement tire might be incompatible with the system, or some component of the TPMS may be damaged.

For detailed information about TPMS, how it works and what you need to know ⇒ *Tire Pressure Monitoring System (TPMS)*.

### WARNING

**New tires tend to be slippery and must be broken in.**

- **Always drive with special care for the first 350 miles (560 km) to help reduce the risk of losing control, a collision, and serious personal injuries.**

## ⚠ WARNING

Tires must have the required clearance. Tires that do not have enough clearance can rub against parts of the vehicle body, suspension, and brake system, causing brake system failure, tread delamination, and sudden blow outs.

- Always make sure that new tires are not larger than the tires approved for your vehicle and that the new tires do not rub against parts of the vehicle.

## ! NOTICE

- When switching to different tires, make certain the valves and sensors are not damaged.
- Never drive without valve stem caps. The valves and sensors could be damaged.
- If the sensor on the Tire Pressure Monitoring System (TPMS) must be replaced, the valve must be replaced at the same time.

🌸 Always dispose of old tires in accordance with legal requirements.

🌸 TPMS wheel sensors are classified as Perchlorate Material – Special handling may apply. Obey all legal requirements regarding handling and disposal of these components – See <http://www.dtsc.ca.gov/hazardouswaste/perchlorate>. Obey all applicable legal requirements regarding handling and disposal of the vehicle or parts of its restraint system, including airbag modules and safety belts with pretensioners. Authorized Volkswagen dealers and authorized Volkswagen Service Facilities are familiar with the requirements, and we recommend that you have them perform this service for you.

**i** If the replacement wheel is different from the tires that you have mounted on your vehicle (for example winter tires or wider, low-profile tires, or a compact spare), then use the replacement wheel for a short time only, and drive cautiously.

- Replace it with a tire matching the others on your vehicle as soon as possible.

**i** Although tire size specifications can be the same, the actual dimensions may differ from those nominal values for different tire makes, or the tire contours may be significantly different.

## Tire inflation pressure



Fig. 111 Location of the tire inflation pressure label.

📖 Please first read and note the introductory information and heed the WARNINGS ⚠

The correct tire inflation pressure for factory-installed tires is listed on a label. The factory-installed tires may be summer, winter, or all-season tires. The label ⇒ [fig. 111](#) is on the driver door jamb.

Under- or over-inflation significantly shortens the service life of your tires and affects the handling of the vehicle ⇒ . The correct tire pressure is very important, particularly when the vehicle is driven at **higher speeds**. Incorrect tire pressure causes increased wear and even sudden tire failure and blowouts.

Therefore tire pressure should be checked at least once a month and always before long trips.

The specified tire inflation pressure applies to a **cold tire**. When tires are warm, the pressure will be higher than when the tires are cold.

Do not reduce the tire pressure on warm tires to match the required cold tire inflation pressure. The tire inflation pressure would then be too low and could cause sudden tire failure and blowout.

### Checking tire inflation pressure

Always check the tire pressure on “cold” tires when the vehicle has not been driven more than a couple of miles (kilometers) at low speed within the last 3 hours.

- Check tire inflation pressure regularly and on cold tires. Check all the tires, including the collapsible spare (if any). In colder climates tire pressure should be checked more often, but only when the tires are cold. Always use an accurate tire pressure gauge.
- After adjusting the tire inflation pressures, make sure to screw the valve caps back on, replace missing valve caps immediately. Please read and heed the information on resetting the Tire Pressure Monitoring System (TPMS) if necessary ⇒ *Tire Pressure Monitoring System (TPMS)*.
- Remember that the vehicle manufacturer, not the tire manufacturer, determines the correct tire pressure for the tires on your vehicle. Never exceed the maximum inflation pressure listed on the tire sidewall for any reason.

Inflate the **spare wheel** to the pressure specified for the vehicle's road wheels on the tire pressure label; inflate a **compact spare wheel** to the pressure specified for the compact spare on the tire pressure label or on a separate label for the compact spare, if there is one.

### **WARNING**

**Incorrect tire pressure can cause a sudden tire failure, or blowout, loss of control, collision, serious personal injury, and even death.**

- Always inflate tires to the recommended and correct cold tire pressure before driving off.
- Low tire pressure can cause tires to get too hot, resulting in tread separation, sudden loss of pressure, and blowouts. Tires with excessively low pressure flex (bend) more, which can cause the tire to overheat and fail suddenly without warning.
- Excessive speed and/or overloading can cause heat buildup, sudden tire failure including a blowout and sudden deflation and loss of control.
- If the tire pressure is too low or too high, the tires will wear prematurely and the vehicle will not handle well.
- Regularly check tire inflation pressure, at least once a month, and also especially before a long trip.
- Check the pressure in all 4 tires when the tires are still cold. Never reduce air pressure in warm tires to match cold tire inflation pressure.

### **NOTICE**

- Make sure not to jam the tire pressure gauge into the valve stem. Otherwise you can damage the tire valves and the tire inflation pressure sensors.

- Driving without valve caps, with the wrong valve caps, or with valve caps that are not properly screwed on can damage the tire valves and the sensors on the Tire Pressure Monitoring System (TPMS). To help prevent damage, always use valve stem caps like those originally installed at the factory. The caps must be screwed on tightly. Do not use metal valve caps or “comfort” valve stem caps.



Underinflation increases fuel consumption.



Pressures measured with a gauge when inflating the tires may be different from the pressures read by the tire pressure sensors. The electronic TPMS is more accurate.



When the TPMS warns that the pressure in at least one tire is too low, check the tire pressure in all 4 tires with an accurate tire pressure gauge. Low tire pressure usually cannot be spotted by looking at the tire. This is especially true for low-profile tires. When checking the tire pressures, refer to → *Tire Pressure Monitoring System (TPMS)*.

## Tire inflation pressure in cold tires

☑ Please first read and note the introductory information and heed the WARNINGS ⚠

Model	Engine	Tire dimensions	Tire inflation pressure, front axle		Tire inflation pressure, rear axle	
			PSI	kPa	PSI	kPa
Touareg	3.0 l / 240 hp (176 kW) TDI	255/55 R 18 109 H xl	33	230	38	260
		265/50 R 19,110 H xl	33	230	38	260
		275/45 R 20,110 H xl	33	230	38	260
Touareg	3.6 l / 280 hp (206 kW) FSI	255/55 R 18,109 H xl	33	230	38	260
		265/50 R 19,110 H xl	33	230	38	260
		275/45 R 20,110 H xl	33	230	38	260
Touareg	3.0 l / 380 hp (279 kW) Hybrid	255/55 R 18,109 H xl	35	240	39	270
		265/50 R 19,110 H xl	35	240	39	270

Model	Engine	Tire dimensions	Tire inflation pressure, front axle		Tire inflation pressure, rear axle	
			PSI	kPa	PSI	kPa
		275/45 R 20,110 H xl	35	240	39	270

xl = reinforced sidewall.

The Tire Pressure Monitoring System (TPMS) is configured at the factory with the correct tire inflation pressure applicable for the vehicle model, engine and factory-installed tires. This tire inflation pressure is also listed on the sticker inside the driver door jamb ⇒ , *Tire inflation pressure*. The tire inflation pressure are listed for all tires and the collapsible spare tire. In the event of a discrepancy between the above figures and the tire pressures listed on the tire inflation pressure label, the pressures listed on the label are the ones you should use. If different tires are installed, the Tire Pressure Monitoring System (TPMS) cannot properly monitor tire inflation pressures unless the TPMS is reset to the new tire pressures ⇒ *Tire Pressure Monitoring System (TPMS)*. Authorized Volkswagen dealers and authorized Volkswagen Service Facilities have the necessary special tools and must reset the TPMS for the new tires on your vehicle.

### Tread depth and tread wear indicators

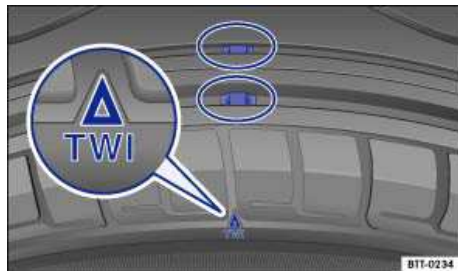



Fig. 112 Tread pattern: Wear indicator.

⚠ Please first read and note the introductory information and heed the WARNINGS ⚠

### Tread depth

Most driving situations require as much tread depth as possible and similar tread depth for the tires on the front and rear wheels. This is especially true when driving in winter weather, at low temperatures and under wet conditions ⇒ .

In most countries the legally permissible minimum tread depth is 06 in (1/16 in; 1.6 mm), as measured in tread grooves next to the wear indicators. Please be sure to obey country-specific legal requirements.

**Winter tires** are no longer suitable for winter operation once the tread pattern is worn down to a depth of 3/16 in (4.8 mm).

The tread depth of new tires can differ between tire models and manufacturers because of the different design features and tread patterns.

### Tread wear indicator (TWI) in the tire

The 1/16 in (1.6 mm) high wear indicators are molded into the bottom of the tread grooves of the original tires running across the treads ⇒ [fig. 112](#). Several wear indicators are evenly spaced around the tire. Markings on the sides of the tires (for example "TWI" or symbols) show the position of the wear indicators.

Wear indicators show when the tires are worn down. The tires must be replaced no later than when the tread pattern is worn down to the wear indicators.

 <b>WARNING</b>	
<b>Worn tires are dangerous and can cause loss of vehicle control including serious personal injuries.</b>	
<ul style="list-style-type: none"><li>• <b>Never drive a vehicle when the tread on any tire is worn down to the wear indicators, replace them sooner.</b></li><li>• <b>Worn tires do not grip the road properly, especially on wet roads, increasing your risk of "hydroplaning" and loss of control.</b></li><li>• <b>Worn tires reduce the ability of your vehicle to handle well in normal and difficult driving situations and increase braking distances and the risk of skidding.</b></li></ul>	

## Tire wear and damage

---

 **Please first read and note the introductory information and heed the WARNINGS **

Wheel rim and tire damage is often difficult to see. Unusual **vibrations** or **pulling to one side** can be an indication of tire damage ⇒ .

- If you suspect tire damage, immediately reduce speed!
- Check tires and wheel rims for damage.
- If a tire is damaged, do not drive any farther. Get expert assistance.
- If no external damage is visible, slowly and carefully drive to the nearest authorized Volkswagen dealer or authorized Volkswagen Service Facility or other qualified workshop and have the vehicle checked.

### Objects embedded in the tire

- If embedded objects have penetrated to the inside of the tire, do not remove them! If objects are stuck in the tread grooves of the tire, they can be removed.
- *With a collapsible spare tire:* If necessary, change the damaged wheel ⇒ *Changing a wheel*. If necessary, get professional assistance to change the wheel.



- *With the tire mobility set:* If necessary, seal and inflate the damaged tire with the tire mobility set => *Tire mobility set.* Get assistance from an authorized Volkswagen dealer, an authorized Volkswagen Service Facility, or another qualified workshop.
- Check tire pressure and adjust if necessary.

### Tire wear

Tire wear depends on several factors, including:

- Driving style.
- Unbalanced wheels.
- Wheel alignment.

*Driving style* – Fast cornering, hard acceleration and braking increase tire wear. If you experience increased tire wear under normal driving conditions, have the vehicle suspension checked by an authorized Volkswagen dealer or authorized Volkswagen Service Facility.

*Unbalanced wheels* – The wheels on a new vehicle are balanced. When driving, however, various conditions can cause a wheel to become unbalanced. Unbalanced wheels can cause wear to the steering and suspension systems. Have all wheels rebalanced. A wheel must always be rebalanced if a new tire has been mounted.

*Wheel alignment* – Incorrect wheel alignment causes excessive and uneven tire wear, impairing vehicle safety. If you notice excessive or uneven tire wear, have the wheel alignment checked by an authorized Volkswagen dealer or authorized Volkswagen Service Facility.

**⚠ WARNING**

**Unusual vibrations or pulling to one side can indicate tire damage.**

- **Reduce speed immediately and stop when it is safe to do so.**
- **Check tires and wheel rims for damage.**
- **Never drive with a damaged tire or rim. Get expert assistance instead.**
- **If no external damage is visible, slowly and carefully drive to the nearest authorized Volkswagen dealer or authorized Volkswagen Service Facility or other qualified workshop and have the vehicle checked.**

### Collapsible spare tire

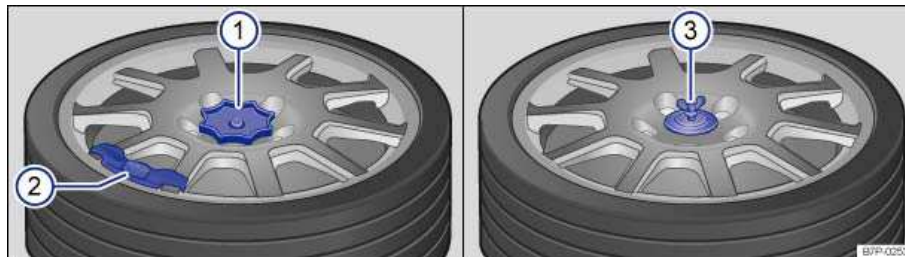

**Fig. 113** Under the luggage compartment floor panel: Collapsible spare tire with threaded retainer (left) and collapsible spare tire with fastening bolt and washer (right).

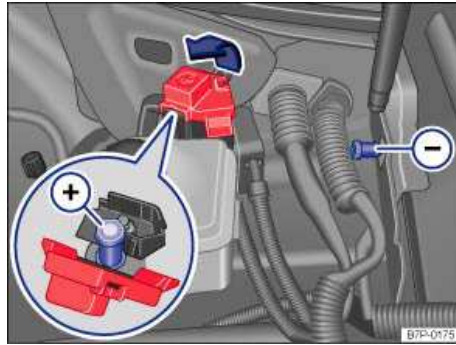

Fig. 114 Connection points in the engine compartment for the collapsible spare tire compressor.

⚠ Please first read and note the introductory information and heed the WARNINGS ⚠

### Removing the collapsible spare tire

- Open the rear hatch: Lift up the luggage compartment floor panel and hook it to the top of the luggage compartment or remove the reversible luggage compartment floor panel ⇒ *Luggage compartment*.
- Take the retainer ⇒ fig. 113 (1) from the middle of the collapsible spare wheel and fit it onto the fastening bolt (2); then unscrew the bolt completely counterclockwise.
- **OR:** Turn the fastening bolt with washer (3) counterclockwise and remove completely.
- Take the collapsible spare tire out of the vehicle.
- Inflate the collapsible spare tire to not more than 51 psi (3.5 bar / 350 kPa) **before** mounting it on the vehicle ⇒ *Inflating the collapsible spare tire*.

### Inflating the collapsible spare tire

- Take the compressor out of the luggage compartment ⇒ *Vehicle tool kit*.
- Screw the tire filler hose onto the valve of the collapsible spare tire.
- Open the engine hood ⇒ *In the engine compartment*.
- Connect the compressor with the 12 Volt clips **only** to the jump-start terminals in the engine compartment ⇒ *Jump-starting*. The red clip on the compressor cable is connected to the positive terminal (+); the black clip is connected to the negative terminal (-) ⇒ fig. 114.
- Route the connector cables so that they cannot get caught in rotating parts.
- Start the vehicle engine and let it run.
- Switch on the compressor. Make sure that the air bleed screw on the tire pressure gauge is closed.
- Inflate the collapsible spare tire to a pressure of 51 psi (3.5 bar / 350 kPa). The compressor must be switched off after 10 minutes at most to keep it from overheating.

### Stowing the tire you removed

- Lift up the luggage compartment floor panel and hook it to the top of the luggage compartment or remove the reversible luggage compartment floor panel ⇒ *Luggage compartment*.
- If necessary, return the vehicle tool kit to its location in the luggage compartment.
- Unhook the luggage compartment floor panel/replace reversible luggage compartment floor panel.
- Put the tire you took off the vehicle in the luggage compartment and secure it firmly.
- Close the rear hatch.

### **Driving with the collapsible spare tire**

The collapsible spare tire is different in design from the road tires and must be used only in the event of a flat tire, only for a brief time, and only when driving with extra caution ⇒ .

Replace it with a tire matching the others on your vehicle as soon as possible.

#### **Please heed the following:**

- Do not drive faster than 50 mph (80 km/h)!
- Avoid full-throttle acceleration, hard braking and fast cornering!
- Do not use snow chains on the collapsible spare tire.
- After installing the collapsible spare tire, check the tire pressure as soon as possible ⇒ *Checking tire inflation pressure.*

### **Reusing the collapsible spare tire**

The collapsible spare tire can be reused as long as it is not damaged and not worn down to the tread wear indicators.

It takes several hours for the collapsible spare tire to return to its collapsed form after you let the air out of it. Once this has happened, you can put it back in the spare tire well and secure it.

- Let the air out of the tire by unscrewing the valve core.
- Screw the valve core back in once the air has been released.
- Wait several hours before putting the collapsible spare tire back in the spare tire well.
- Once the time is up, open the rear hatch. Lift up the luggage compartment floor panel and hook it to the top of the luggage compartment or remove the reversible luggage compartment floor panel ⇒ *Luggage compartment.*
- Place the collapsible spare tire in the spare tire well and secure it with the fastening bolt (⇒ [fig. 113 \(2\)](#) or [\(3\)](#)).
- Fit the retainer [\(1\)](#) back into the middle of the collapsible spare tire ⇒ [fig. 113](#).
- Unhook the luggage compartment floor panel/replace reversible luggage compartment floor panel.
- Close the rear hatch.



## WARNING

Improper use of a collapsible spare tire can cause loss of vehicle control, a crash or other accident, and serious personal injury.

- Never use a collapsible spare tire if it is damaged or worn down to the wear indicators.
- The collapsible spare tire is identified by a sticker and the words “50 mph” or “80 km/h”. This is the maximum permissible speed when driving with this tire.
- Never drive faster than 50 mph (80 km/h) with a collapsible spare tire. Avoid full-throttle acceleration, heavy braking, and fast cornering!
- Never drive more than 125 miles (200 km) if a compact spare wheel is installed on the front axle (drive axle).
- Replace the collapsible spare tire with a normal wheel as soon as possible. Collapsible spare tires are designed for brief use only.
- Regularly check U.S. DOT tire identification number (TIN) to determine the age of the collapsible spare tire ⇒ *Tire labeling*. Tires age even if they are not being used and can fail suddenly, especially at higher speeds.
- Tires that are more than 6 years old can only be used in an emergency and then with special care and at lower speeds.
- The collapsible spare tire must always be secured with the wheel bolts provided by the factory.
- Never drive using more than one collapsible spare tire.
- After installing the collapsible spare tire, the tire pressure must be checked as soon as possible ⇒ *Tire inflation pressure*.
- Snow chains cannot be used on the collapsible spare tire. If you need the snow chains, but one of the front tires is flat, you have to mount the collapsible spare tire on the rear axle. The tire taken off the rear axle can then be used to replace the flat front tire. Be sure to maintain the tire's direction of rotation. Install the snow chains on the full-sized road wheel.



If possible, fasten the collapsible spare tire or the wheel you took off the vehicle securely in the luggage compartment. On vehicles equipped with a tire mobility set, the tire you took off the vehicle **cannot** be secured.

## Tire labeling

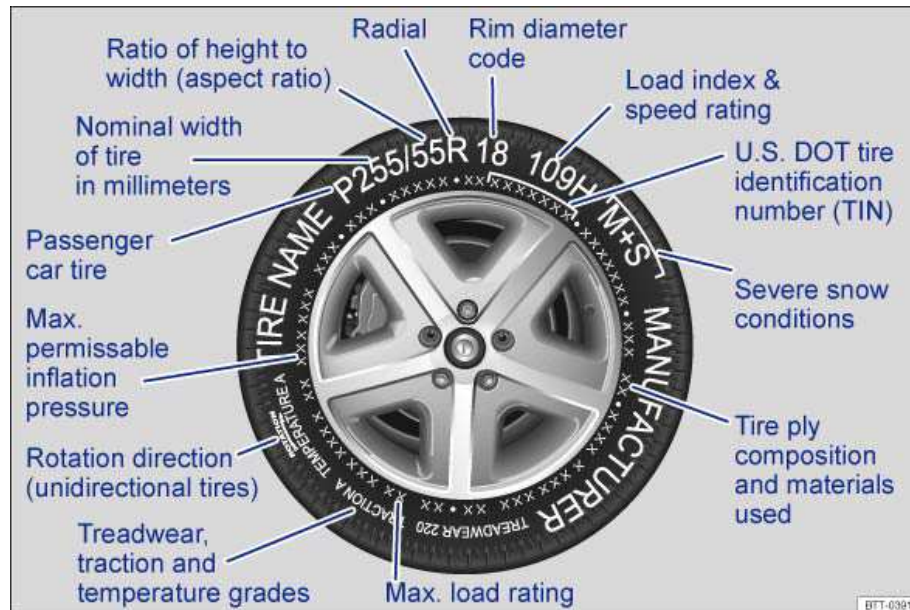

Fig. 115 International tire labeling.

⚠ Please first read and note the introductory information and heed the WARNINGS ⚠

Knowing about tire specifications makes it easier to choose the correct replacement tires. Radial tires have specifications marked on the sidewall.

Tire labeling (example)	Meaning						
<i>Brand, Logo</i>	<i>Manufacturer</i>						
<i>Tire name</i>	Individual tire designation of the manufacturer.						
P255 / 55 R 18	Dimensions:						
	<table border="1"> <tr> <td>P</td> <td>Tire application: Passenger car</td> </tr> <tr> <td>255</td> <td>Nominal sidewall-to-sidewall width of tire in millimeters.</td> </tr> <tr> <td>55</td> <td>Ratio of height to width (aspect ratio)</td> </tr> </table>	P	Tire application: Passenger car	255	Nominal sidewall-to-sidewall width of tire in millimeters.	55	Ratio of height to width (aspect ratio)
P	Tire application: Passenger car						
255	Nominal sidewall-to-sidewall width of tire in millimeters.						
55	Ratio of height to width (aspect ratio)						

Tire labeling (example)	Meaning	
	R	Tire belt design letter code for radial.
	18	Rim diameter (in inches)
109 H	Load rating code and speed rating code ⇒ <i>Tire labeling.</i>	
XL	Indicates “reinforced” tire (heavy-duty)	
M+S <i>or</i> M/S	Indicates Mud and Snow capability (also M/S)	
RADIAL TUBELESS	Tubeless radial tire.	
E4 ...	Labeling according to international regulations (E) including number of the approving country. The multi-digit approval number is listed next.	
DOT BT RA TY5 1709	Tire identification number ( <b>TIN</b> <sup>3</sup> - In some cases the manufacturing date is only on one side of the tire:	
	DOT	The tire complies with the requirements of the United States Department of Transportation, responsible for issuing safety standards.
	BT	Identification letter of the manufacturing site.
	RA	Manufacturer information regarding tire dimensions.
	TY5	Tire characteristics provided by the manufacturer.
	1709	Manufacturing date: 17th week in 2009.

<sup>3</sup> TIN represents the serial number of the tire.

<b>Tire labeling (example)</b>	<b>Meaning</b>
TWI	Marks the position of the treadwear indicator
Made in Germany	Country of manufacture.
MAX LOAD 615 KG (1356 LBS)	United States maximum load rating per wheel.
MAX INFLATION 350 KPA (51 PSI)	United States maximum permissible inflation pressure.
ROTATION	Rotation direction (unidirectional tires)
SIDEWALL 1 PLY RAYON	Tire ply composition and materials used: 1 layer of rayon.
TREAD 4 PLYS 1 RAYON + 2 STEEL + 1 NYLON	Tire tread composition and materials used: In this example there are 4 layers under the tread: 1 layer of rayon, 2 layers of steel belt and 1 layer of nylon.

**Consumer information regarding comparison to specified base tires (standardized test procedure):**

TREADWEAR 220	Relative service life expectancy of the tire referenced to a US-specific standard test.
TRACTION A	Traction rating under wet conditions (AA, A, B or C).
TEMPERATURE A	Temperature stability of the tire at increased test bench speeds (A, B or C).

**Additional numbers found on the tire could either be tire manufacturer internal labels or country-specific labels (such as for Brazil and China).**

**Unidirectional tires**

Unidirectional tires are designed to rotate only in one direction. Unidirectional tires have arrows on the sidewalls that show the direction of rotation. Make sure you mount the tire so that it rotates in the

proper direction. The tire's performance with regard to hydroplaning, traction, noise, and wear is worse if it is not mounted in the proper direction of rotation.

If you have to mount a tire opposite to its proper direction of rotation, you must drive more carefully, since the tire is no longer being used as designed. This is particularly important on wet roads. You must replace or remount the tire as soon as possible in order to restore the correct direction of rotation.

#### **Load rating code**

The load index indicates the maximum permissible load per individual tire in pounds (kilograms).

91	1356 lbs (615 kg)
92	1388 lbs (630 kg)
93	1433 lbs (650 kg)
95	1521 lbs (690 kg)
97	1609 lbs (730 kg)
98	1653 lbs (750 kg)
99	1709 lbs (775 kg)
100	1763 lbs (800 kg)
101	1819 lbs (825 kg)
102	1874 lbs (850 kg)
103	1929 lbs (875 kg)
104	1984 lbs (900 kg)
110	2337 lbs (1060 kg)

#### **Speed rating code letter**

The speed rating code letter indicates the maximum permissible road speed of the tires.

P	up to 93 mph (150 km/h)
Q	up to 99 mph (160 km/h)
R	up to 106 mph (170 km/h)
S	up to 112 mph (180 km/h)
T	up to 118 mph (190 km/h)
U	up to 124 mph (200 km/h)
H	up to 130 mph (210 km/h)
V	up to 149 mph (240 km/h)
Z	over 149 mph (240 km/h)
W	up to 168 mph (270 km/h)
Y	up to 186 mph (300 km/h)

Some tire manufacturers label tires with a maximum permissible road speed above 149 mph (240 km/h) with the letter combination "ZR."



## WARNING

Using incorrect or unmatched tires and/or wheels or improper tire and wheel combinations can lead to loss of control, collision and serious personal injury.

- Always use tires, wheels and wheel bolts that meet the specifications of the original factory-installed tires or other combinations that have been specifically approved by the vehicle manufacturer.
- All 4 wheels must be fitted with radial tires of the same type, the same size (tread circumference), and the same tread pattern. Driving with different tires reduces vehicle handling and can lead to a loss of control.
- Never drive faster than the maximum speed for which the tires installed on your vehicle are rated because tires that are driven faster than their rated speed can fail suddenly.
- Overloading tires can cause heat build-up, sudden tire failure, including a blowout and sudden deflation and loss of control.
- Temperature grades apply to tires that are properly inflated and not over- or underinflated.

## Winter tires

 Please first read and note the introductory information and heed the WARNINGS 

Winter tires improve the handling characteristics of your vehicle significantly when driving under wintry road conditions. Summer tires have less traction on snow and ice because of their design (width, rubber composition, tread design). Volkswagen strongly recommends that you always have winter tires or all-season tires installed on all 4 wheels on your vehicle, especially when winter road conditions are expected. Winter tires also improve the vehicle's braking performance and help reduce stopping distances during winter weather. Volkswagen recommends installing winter tires once temperatures are below +45 °F (+7 °C).

Winter tires are no longer suitable for winter driving once the **tread pattern** is worn down to a depth of 3/16 in (4.8 mm). In addition, winter tire performance decreases with **age** – independent of the tread profile depth.

### When using winter tires:

- Obey state and country-specific legal requirements.
- Install winter tires on all 4 wheels.
- Use winter tires only under wintry road conditions.
- Only use winter tires with dimensions approved for the vehicle.
- Use only winter tires of the same tire belt design, the same dimensions (tread circumference), and the same tread design.
- Follow speed restrictions according to the winter tire's speed rating code letter ⇒ .

### Speed restrictions

Winter tires are certified up to a top speed identified by speed rating code letters on the side wall ⇒ *Tire labeling*.

In some vehicle models it is possible to set a speed warning in the **MFI** menu in the instrument cluster display ⇒ *Volkswagen Information System*.

Top speed rating and tire inflation pressure for **V winter tires** depend on the engine installed in your vehicle. Be sure to ask your authorized Volkswagen dealer or authorized Volkswagen Service Facility about the maximum permissible speed and the required tire inflation pressure for the winter tires that you plan to use.

### All-wheel drive (4MOTION)

Vehicles with all-wheel drive and standard road wheels have good forward motion and traction even under wintry road conditions. However, Volkswagen recommends installing snow tires or all season tires on *all 4 wheels* to improve handling as well as *braking performance*.

If you use **snow chains**, please read and heed information and directions ⇒ *Snow chains*.

 **WARNING**

**Driving faster than the maximum speed for which the winter tires on your vehicle were designed can cause sudden tire failure including a blowout and sudden deflation, loss of control, crashes and serious personal injuries.**

- **Winter tires have a maximum speed rating that may be lower than your vehicle's maximum speed.**
- **Never drive faster than the maximum speed for which the winter tires installed on your vehicle are rated because tires that are driven faster than their rated speed can fail suddenly.**
- **Never exceed the maximum load rating for the winter tires installed on your vehicle.**

 Install summer tires promptly in the spring. Summer tires offer better handling characteristics for temperatures above +45 °F (+7 °C). They are quieter, do not wear as quickly, and reduce fuel consumption.

 If factory-installed wheels and/or tires are replaced when installing winter tires, make sure that the wheels are equipped with sensors that are compatible with the factory-installed Tire Pressure Monitoring System (TPMS) and that the tires are also compatible with the system ⇒ *Tire Pressure Monitoring System (TPMS)*. If new tires are not identical to those that were removed and require different cold tire inflation pressure, the tire inflation pressure values must be reprogrammed for the TPMS. Please see your authorized Volkswagen dealer or authorized Volkswagen Service Facility ⇒ *Tire Pressure Monitoring System (TPMS)*.

 If necessary, ask your authorized Volkswagen dealer or authorized Volkswagen Service Facility about permissible winter tire dimensions.

### Snow chains

 **Please first read and note the introductory information and heed the WARNINGS **

Obey local regulations as well as the applicable speed limits when driving with snow chains.

Snow chains improve forward motion, traction and braking characteristics under wintry conditions.

Snow chains may be used **only on the front wheels** when driving on roads and highways. This applies even to **all-wheel drive vehicles** (4MOTION). Snow chains may be used **only in the following tire and wheel rim combinations**:

Tire dimensions	Rim
235/65 R17	7 1/2 J x 17 ET 55

Tire dimensions	Rim
255/60 R17	7 1/2 J x 17 ET 55
255/55 R18	8 J x 18 ET 57

Please contact your authorized Volkswagen dealer or authorized Volkswagen Service Facility about appropriate wheel, tire and snow chain dimensions.

If possible, use only chains with low profile links that are not thicker than 37/64 in (15 mm) including the tensioner.

Remove center hubcaps and decorative rim rings before installing snow chains ⇒ . However, for safety reasons, caps must be installed on the wheel bolts. These are available from authorized Volkswagen dealers and authorized Volkswagen Service Facilities.

#### Collapsible spare

For technical reasons, snow chains cannot be used on the collapsible spare ⇒ *Collapsible spare tire*.

If you must use snow chains and have a collapsible spare tire mounted, move the collapsible spare to the rear axle, if a front tire has to be replaced. The tire taken off the rear axle can then be used to replace the flat front tire. Be sure to install the unidirectional tires so that they will run in the proper direction. Volkswagen recommends installing the snow chains before mounting the wheel to the vehicle.

#### WARNING

Using the wrong snow chains or installing snow chains improperly can cause accidents and severe personal injuries.

- Always use the proper snow chains.
- Follow the installation instructions provided by the snow chain manufacturer.
- Never exceed the permissible speed limit when driving with snow chains.

#### NOTICE

- Remove snow chains when roads are free of snow. Otherwise, the chains can damage the tires, impair vehicle handling and can be quickly worn down.
- Snow chains can scratch or damage wheel rims, if they have direct contact with the rims. Volkswagen recommends using coated snow chains.



Snow chains are available in different sizes for each vehicle model.

### [Glossary of tire and loading terminology](#)

 Please first read and note the introductory information and heed the WARNINGS 

**Accessory weight**

The combined weight (in excess of those standard items which may be replaced) of automatic transmission, electro-mechanical power steering, power brakes, power windows, power seats, radio, and heater, to the extent that these items are available as factory-installed equipment (whether installed or not).

**Aspect ratio**

The ratio of sidewall height to tire width, expressed as a percentage. A number of 70 (0.7:1 or 70%) or lower indicates a low-profile tire with a shorter sidewall for improved steering response and better overall handling on dry pavement.

**Bead**

The part of a tire made of steel wires, wrapped or reinforced by ply cords, with the shape and structure to ensure proper fit to the wheel rim.

**Bead separation**

A breakdown of the bond between components in the bead.

**Carcass**

The tire structure, except tread and sidewall rubber which, when inflated, bears the load.

**Chunking**

The breaking away of pieces of the tread or sidewall.

**Cord**

The strands of material forming the plies in the tire.

**Cord separation**

The parting of cords from adjacent rubber compounds.

**Cracking**

Any parting within the tread, sidewall, or inner liner of the tire extending to cord material.

**Cold tire inflation pressure**

The tire pressure recommended by the vehicle manufacturer for a tire of a specified size that has not been driven for more than a couple of miles (kilometers) at low speeds in the 3 hour period before the tire pressure is measured or adjusted.

**Curb weight**

The weight of a motor vehicle with standard equipment including the maximum capacity of fuel, oil, and coolant, air conditioner, and additional weight of optional equipment.

**Extra load tire**

A tire designed to operate at higher loads and at higher inflation pressures than the corresponding standard tire.

**Gross Axle Weight Rating (GAWR)**

The load-carrying capacity of a single axle system, measured where the tire contacts the ground.

**Gross Vehicle Weight Rating (GVWR)**

The maximum loaded weight of the vehicle.

**Groove**

The space between 2 adjacent tread ribs.

**Load rating (code)**

The maximum load that a tire is rated to carry for a given inflation pressure. You may not find this information on all tires because it is not required by law.

**Maximum load rating**

The load rating for a tire at the maximum permissible inflation pressure for that tire.

**Maximum loaded vehicle weight**

The total of:

- Curb weight
- Accessory weight
- Vehicle capacity weight
- Production options weight

**Maximum (permissible) inflation pressure**

The maximum cold inflation pressure to which a tire may be inflated. Also called "maximum inflation pressure."

**Normal occupant weight**

Means 150 lbs (68 kilograms) times the number of occupants seated in the vehicle up to the total seating capacity of your vehicle.

**Occupant distribution**

The placement of passengers in a vehicle.

**Outer diameter**

The diameter of a new, properly inflated tire.

**Overall width**

Total width measured at the exterior sidewalls of an inflated tire, including the additional width of labeling, decorations, or protective bands or ribs.

**Passenger car tire**

A tire intended for use on passenger cars, multipurpose passenger vehicles, and trucks, that have a gross vehicle weight rating (GVWR) of 10,000 pounds or less.

**Ply**

A layer of rubber-coated parallel cords.

**Ply separation**

A parting of rubber compound between adjacent plies.

**Pneumatic tire**

A mechanical device made of rubber, chemicals, fabric, and steel or other materials, that, when mounted on an automotive wheel, provides the traction and contains the gas or fluid that sustains the load.

**Production options weight**

The combined weight of installed regular production options weighing over 5 lbs (2.3 kg) more than the standard items they replace, and not previously considered as curb weight or accessory weight. These include, for example, heavy-duty brakes, ride levelers, roof rack, heavy-duty battery, and special trim.

**Radial ply tires**

A pneumatic tire in which the ply cords that extend to the beads are laid at substantially 90 degrees to the centerline of the tread.

**Recommended inflation pressure**

The tire pressure recommended by the vehicle manufacturer for a tire of a specified size that has not been driven for more than a couple of miles (kilometers) at low speeds in the 3 hour period before the tire pressure is measured or adjusted.

**Reinforced tire**

A tire designed to operate at higher loads and at higher inflation pressures than the corresponding standard tire.

**Rim**

The outer edge of a wheel upon which the tire beads are seated.

**Rim diameter**

The nominal diameter of the wheel's tire bead seating surface. If you change your wheel size, to wheels of a different diameter, you will have to purchase new tires to match the new wheels.

**Rim size**

Designation means rim diameter and width.

**Rim type designation**

The industry or manufacturer's designation for a rim by style or code.

**Rim width**

The nominal distance between wheel rim flanges.

**Section width**

The linear distance between the exteriors of the sidewalls of an inflated tire, excluding elevations due to labeling decoration, or protective bands.

**Sidewall**

The portion of a tire between the bead and the tread.

**Sidewall separation**

The parting of the rubber compound from the cord material in the sidewall.

**Speed rating (letter code)**

A standardized letter code indicating the maximum speed at which a tire is designed to be driven for extended periods of time. The ratings range from 93 mph or 150 km/h ("P") to 186 mph or (300 km/h) "Y".

The speed rating letter code, where applicable, is molded on the tire sidewall ⇒ *Tire labeling*. You may not find this information on all tires because it is not required by law.

**Tire Pressure Monitoring System (TPMS)**

A system that detects when at least one of a vehicle's tires is underinflated and illuminates a low tire-pressure warning light.

**Tread**

The portion of a tire that normally touches the road.

**Tread rib**

A tread section running circumferential around a tire.

**Tread separation**

Tire failure caused by the tread pulling away from the tire carcass.

**Tread wear indicators (TWI)**

Raised areas within the main tread grooves that show, visually, when tires are worn and near the end of their useful life ⇒ *Tread depth and tread wear indicators.*

**Uniform Tire Quality Grading (UTQG)**

A tire information system developed by the U.S. National Highway Traffic Safety Administration (NHTSA) that is designed to help buyers compare tires. UTQG is not a safety rating, nor is it a guarantee that a tire will last for a certain number of miles or perform a certain way. It gives tire buyers more information to compare with factors such as price, brand loyalty and dealer recommendations. Under UTQG, tires are graded by the tire manufacturers in 3 areas: tread wear, traction and temperature resistance. UTQG information is molded into the tire sidewalls.

**U.S. DOT Tire Identification Number (TIN)**

A tire's serial number. It begins with the letters "DOT" ("Department of Transportation") and indicates that the tire meets all federal standards. The next 2 numbers or letters indicate the plant where the tire was manufactured. The last 4 numbers represent the week and year of manufacture.

For example, the numbers 1801 mean that the tire was produced in the 18th week of 2001. Any other numbers are marketing codes used by the tire manufacturer. This information is used to help identify affected consumers if a tire defect requires a recall.

**Vehicle capacity weight**

The total rated cargo, luggage and passenger load. Passenger load is 150 lbs (68 kilograms) times the vehicle's total seating capacity (as listed on the label inside the driver door).

**Vehicle maximum load on the tire**

The load on an individual tire that is determined by taking each axle's share of the maximum loaded vehicle weight (GAWR) and dividing by 2.

**Vehicle normal load on the tire**

The load on an individual tire that is determined by taking each axle's share of the curb weight, accessory weight, and normal occupant weight (distributed according to the table below) and dividing by 2.

**Wheel size designation**

Wheel rim diameter and width.

**OCCUPANT LOADING AND DISTRIBUTION FOR VEHICLE NORMAL LOAD FOR VARIOUS DESIGNATED SEATING CAPACITIES**

<b>Designated seating capacity, number of occupants</b>	<b>Vehicle normal load, number of occupants</b>	<b>Occupant distribution in a normally loaded vehicle</b>
2,3 or 4	2	2 in front

Designated seating capacity, number of occupants	Vehicle normal load, number of occupants	Occupant distribution in a normally loaded vehicle
5	3	2 in front, 1 in back

## Tires and vehicle load limits

### Please first read and note the introductory information and heed the WARNINGS

There are limits to the load any vehicle or any tire can carry. A vehicle that is overloaded will not handle well and is more difficult to stop. Overloading can damage important parts of the vehicle. Overloading can also lead to blowout, sudden loss of pressure or other tire failure that can cause loss of control.

Your safety and the safety of your passengers depends on making sure that load limits are not exceeded. Vehicle load includes everybody and everything in and on the vehicle. These load limits are technically referred to as the vehicle's **Gross Vehicle Weight Rating (GVWR)**.

The GVWR includes the weight of the basic vehicle, all factory-installed and other accessories, a full tank of fuel, oil, coolant and other fluids plus maximum load. The maximum load includes the number of passengers that the vehicle is intended to carry (seating capacity) with an assumed weight of 150 lbs (68 kg) for each passenger at a designated seating position and the total weight of any luggage in the vehicle. If you tow a trailer, the weight of the trailer hitch and the tongue weight of the loaded trailer must be included as part of the vehicle weight. At altitudes above 3000 ft (1000 m), combined towing weight (vehicle plus trailer) must be reduced by 10% for every 3000 ft (1000 m).

**The Gross Axle Weight Rating (GAWR)** is the maximum load that can be carried at each of the vehicle's 2 axles (by the front or rear tires). GVWR and GAWR are listed on the safety compliance label on the driver's door jamb. Your vehicle has 5 total seating positions: 2 in the front and 3 in back. Each seating position has a safety belt. Because there is an upper limit to your vehicle's total weight (GVWR), the weight of whatever is being carried (including the weight of a trailer hitch and the tongue weight of the loaded trailer) is also limited. More passengers, or passengers who are heavier than the assumed 150 lbs (68 kg), mean that less weight can be carried as luggage or other cargo. The tire pressure label on your Volkswagen also lists the maximum combined weight of all of the occupants and luggage or other cargo that the vehicle can carry.

### **WARNING**

Overloading a vehicle can cause loss of vehicle control, a crash or other accident, serious personal injury, and even death.

- Carrying more weight than your vehicle was designed to carry will prevent the vehicle from handling properly and increase the risk of the loss of vehicle control.
- The brakes on a vehicle that has been overloaded may not be able to stop the vehicle in a safe distance.
- Tires on a vehicle that has been overloaded can fail suddenly, including a blowout and sudden deflation, causing loss of control and a crash.
- Always make sure that the total load being transported – including the weight of a trailer hitch and the tongue weight of a loaded trailer – does not make the vehicle heavier than the vehicle's Gross Vehicle Weight Rating.



## Determining the correct load limit

---

**ⓘ Please first read and note the introductory information and heed the WARNINGS ⚠**

Never overload tires. The following example illustrates how to determine the combined weight of all vehicle occupants and luggage or other vehicle payloads. Never overload the vehicle!

### Steps for Determining Correct Load Limit:

---

---

1. Locate the statement “THE COMBINED WEIGHT OF OCCUPANTS AND CARGO SHOULD NEVER EXCEED XXX KG OR XXX LBS” on your vehicle’s placard (tire inflation pressure label)
2. Determine the combined weight of the driver and passengers that will be riding in your vehicle.
3. Subtract the combined weight of the driver and passengers from XXX kg or XXX lbs.
4. The resulting figure equals the available amount of cargo and luggage load capacity.  
For example, if the “XXX” amount equals 1400 lbs. and there will be five 150 lb. passengers in your vehicle, the amount of available cargo and luggage load capacity is 650 lbs. (1400-750 (5 x 150) = 650 lbs.)
5. Determine the combined weight of luggage and cargo being loaded on the vehicle. That weight may not safely exceed the available cargo and luggage load capacity calculated in Step 4.
6. If your vehicle will be towing a trailer, load from your trailer will be transferred to your vehicle. Consult this Manual to determine how this reduces the available cargo and luggage capacity of your vehicle.

---

Check the tire sidewall to determine the load index specified for the tire.

---

## UTQG classification

---

**ⓘ Please first read and note the introductory information and heed the WARNINGS ⚠**

Uniform Tire Quality Grading (UTQG): Quality grades can be found where applicable on the tire sidewall between the tread shoulder and maximum section width. Example:

- Treadwear (number)
- Traction: AA, A, B or C
- Temperature: A, B or C

For example: Treadwear 200, Traction AA Temperature A

All passenger car tires must conform to Federal Safety Requirements in addition to these grades.

### **Treadwear**

The tread wear grade is a comparative rating based on the wear rate of the tire when tested under controlled conditions on a specified government test course.

For example, a tire graded 150 (Tread wear-value 150) would wear one-and-one-half (1 1/2) times as well on the government course as a tire graded 100.

The relative performance of tires depends upon the actual conditions of their use, however, and may depart significantly from the norm due to variations in driving habits, service practices and differences in road characteristics and climate.

### **Traction**

The traction grades from highest to lowest, are AA, A, B and C. Those grades represent the tire's ability to stop on wet pavement as measured under controlled conditions on specified government test surfaces of asphalt and concrete. A tire marked C may have poor traction performance ⇒ ⚠.

### **Temperature**

The temperature grades are A (the highest), B, and C representing the tire's resistance to the generation of heat, and its ability to dissipate heat when tested under controlled conditions on a specified indoor laboratory test wheel.

Sustained high temperature can cause the material of the tire to degenerate and reduce tire life, and excessive temperature can lead to sudden tire failure.

The grade C corresponds to a level of performance which all passenger car tires must meet under the Federal Motor Vehicle Safety Standard No. 109. Grades B and A represent higher levels of performance on the laboratory test wheel than the minimum required by law ⇒ ⚠.

### **WARNING**

**The traction grade assigned to this tire is based on straight-ahead braking traction tests, and does not include acceleration, cornering, hydroplaning or peak traction characteristics.**

### **WARNING**

**The temperature grade for this tire is established for a tire that is properly inflated and not overloaded. Excessive speed, underinflation or excessive loading, either separately or in combination, can cause heat buildup and possible tire failure.**

# Tire Pressure Monitoring System (TPMS)

## Introduction

---

In this section you'll find information about:

Indicator light (telltale) 

Tire Pressure Monitoring System (TPMS)

The Tire Pressure Monitoring System (TPMS) uses a pressure sensor in each wheel. Signals from the sensors are transmitted to the TPMS.

The TPMS checks the tire pressure of all 4 tires while you are driving and warns if there is a loss of pressure while the vehicle is moving. Pressure loss that is 25 % or more of the benchmark value programmed into the system is signaled by the indicator light (telltale), by acoustic warnings, and by text messages in the instrument cluster display.

### **More information:**

- Volkswagen Information System
- Transporting
- Braking and parking
- Exterior care and cleaning
- Tires and wheels
- Parts, accessories, repairs and modifications
- Consumer Information



## WARNING

Incorrect tire pressures and/or underinflation can cause sudden tire failure, loss of control, collision, serious personal injury or even death.

- When the warning symbol appears in the instrument cluster, stop and inspect the tires.
- Incorrect tire pressure and/or underinflation can cause increased tire wear and can affect the handling of the vehicle and stopping ability.
- Incorrect tire pressures and/or underinflation can also lead to sudden tire failure, including a blowout and sudden deflation, causing loss of vehicle control.
- The driver is responsible for the correct tire pressures for all tires on the vehicle. The recommended tire pressure values are listed on a sticker on the driver door ⇒ *Tires and wheels*.
- The TPMS can only work correctly when all tires on the vehicle are filled to the correct cold tire pressure specified for the tires installed on the vehicle.
- Using incorrect tire pressure values can cause accidents or other damage. Always inflate the tires to the correct specified cold tire pressure values for the tires installed on the vehicle.
- Always maintain correct cold tire inflation pressure so that TPMS can do its job.
- Always inflate tires to the recommended and correct tire pressure before driving off.
- Driving with underinflated tires causes them to flex (bend) more, letting them get too hot, resulting in tread separation, sudden tire failure, and loss of control.
- Excessive speed and/or overloading can cause heat build-up, sudden tire failure and loss of control.
- If the tire pressure is too low or too high, the tires will wear prematurely and the vehicle will not handle well.
- If the tire is not “flat” and you do not have to change a wheel immediately, drive carefully and at reduced speed to the nearest service station to check the tire pressure and add air as required.
- When replacing tires or wheel rims on vehicles equipped with TPMS always read and heed the information and all WARNINGS regarding *Tires and wheels* ⇒ *Tires and wheels*.



## NOTICE

- The wheel electronics are attached to special aluminum valves on the wheels. These valves are screwed on rigidly. Never bend the valves “into position” when checking and adjusting tire pressure.
- Missing valve stem caps can cause damage to the valves as well as to the TPMS sensors. To help prevent damage, always use valve stem caps like those originally installed at the factory. The caps must be screwed on tightly. Do not use metal valve stem caps.
- Do not use “comfort valve caps”. They do not seal properly and can damage the sensors.
- When switching to different tires, make certain the valves and sensors are not damaged.
- When replacing the valve cores, use only nickel-plated replacement cores.
- The batteries in the wheel electronics have a life of up to 10 years. It is not possible to replace the batteries. The entire device must be replaced.





Underinflation increases fuel consumption and tire wear.



Dispose of the wheel electronics and the old batteries in an environmentally responsible manner. Batteries of the type used in the wheel electronics may contain Perchlorate Material. Special handling

may apply. See <http://www.dtsc.ca.gov/hazardouswaste/perchlorate>. Obey all applicable legal requirements regarding proper disposal.

 Do not rely solely on the Tire Pressure Monitoring System (TPMS). Check your tires regularly to make sure they are properly inflated and have no signs of damage, such as punctures, cuts, cracks, and blisters. Remove any objects that become embedded in the tire tread but have not penetrated into the body of tire itself.

 When you take delivery of the vehicle, the Tire Pressure Monitoring System (TPMS) is calibrated for the factory-recommended cold tire inflation pressure for the tires on your vehicle, as shown on the label inside the driver door ⇒ [fig. 111](#).

- For replacement tires that require a different inflation pressure, the TPMS must be adjusted to the new pressure specification by an authorized Volkswagen dealer or an authorized Volkswagen Service Facility. Only one value can be entered for each tire partial or full load; see the tire inflation pressure label on the driver door pillar ⇒ *Tire inflation pressure*.
- To help prevent damage to the sensor and valve, do not put excessive force on the valve when checking the tire pressure. Do not try to bend the valve.
- If sensors have to be replaced, have the valves changed at the same time.
- The tire valve gaskets must be replaced whenever a tire is mounted on the rim. Your authorized Volkswagen dealer or authorized Volkswagen Service Facility has a valve seal and gasket kit for this purpose. Always make sure that a valve seal and gasket kit is also used whenever a sensor is replaced.
- If you have to adjust the tire pressure on a “warm” tire, fill the tire with 2.0 - 4.35 psi (20 - 30 kPa) more than the pressure specified on the tire pressure label.
- When the TPMS determines that the air pressure in at least one tire is too low, carefully check the pressure in all 4 tires with an accurate tire pressure gauge. Low tire pressure usually cannot be determined by looking at the tire. This is especially true of low-profile tires.
- A Declaration of Compliance with the United States FCC and Industry Canada regulations is found on of this manual.

 There may be differences between the pressure readings from a tire pressure gauge and the pressures registered by the Tire Pressure Monitoring System (TPMS). The electronic TPMS is more accurate.

 If you have work done on your wheels or tires, inform the workshop that the vehicle is equipped with a Tire Pressure Monitoring System (TPMS) that has sensors in the wheels.

 New tires may expand slightly the first time they are driven at high speeds, which can trigger a tire pressure warning. Remember that tire pressure can only be properly measured when the tire is “cold” ⇒ *Tires and wheels*.

## Indicator light (telltale)

 Please first read and note the introductory information and heed the WARNINGS 

Lights up	Display text	Possible cause or meaning ⇒ ⚠	Proper response
ⓘ	FLAT TIRE	Rapid loss of pressure in one or more tires. At least one tire has a pressure below 20.3 psi (1.4 bar) or a loss of tire pressure greater than 2.9 psi/min (0.2 bar/min).	 <b>Stop!</b> Reduce speed immediately! Stop the vehicle as soon as it is safe to do so. Avoid fast cornering and hard braking!
			Check all tires for external damage and embedded objects. Check the inflation pressure of all 4 tires. If you are sure it is not necessary to change a tire right away, drive at reduced speed to the nearest authorized Volkswagen dealer or authorized Volkswagen Service Facility .
ⓘ	CHECK TIRE PRESSURES	Critical loss of pressure of 25% or more in at least in one or more tires (compared with benchmark pressure setting) with the pressure more than 7.25 psi (0.5 bar) below the specified value.	Immediately check the tire inflation pressure of all tires. If you are sure it is not necessary to change a tire right away, drive at reduced speed to the nearest authorized Volkswagen dealer or authorized Volkswagen Service Facility.

Flashes	Display text	Possible cause or meaning ⇒ ⚠	Proper response
ⓘ	–	Possible communi-	Switch the source of in-

Flashes	Display text	Possible cause or meaning ⇒ ⚠	Proper response
(Intermittently while driving.)		cation problem between a sensor and the system. This may be caused by interference from a nearby radio transmitter (such as a mobile phone or other broadcast device) that uses the same frequency range. The indicator light should stop flashing as soon as you are far enough away from the device causing the interference.	interference off.
⚠	–	There is a system malfunction if the indicator light flashes for about 65 seconds and then stays on <i>continuously</i> .	If the tire pressure is correct but the indicator light stays on or keeps flashing after you switch the ignition off and on again, have an authorized Volkswagen dealer or an authorized Volkswagen Service Facility check the system.

When the ignition is switched on, several warning and indicator lights come on briefly for a function check. They go out after a few seconds.



## WARNING

Incorrect tire pressures and/or underinflation can cause sudden tire failure, loss of control, collision, serious personal injury, or even death.

- When the warning symbol (⚠) appears in the instrument cluster, stop the vehicle as soon as it is safe to do so and inspect all tires.
- Incorrect tire pressure and/or underinflation can cause increased tire wear and can affect the handling of the vehicle and its stopping ability.
- Incorrect tire pressure and/or underinflation can also lead to sudden tire failure, including a blowout and sudden deflation, causing loss of vehicle control.
- The driver is responsible for the correct tire pressures for all tires on the vehicle. The recommended tire pressure values are listed on a sticker inside the driver's door ⇒ [fig. 111](#).
- The TPMS can only work correctly when all tires on the vehicle are filled to the correct cold tire inflation specified for the tires installed on the vehicle. Always set and maintain the correct cold tire inflation pressure so that TPMS can do its job.
- Using incorrect tire pressure values can cause accidents or other damage. Check the pressure in all 4 tires when the tires are still cold. Never reduce air pressure in warm tires to match cold tire inflation pressure.
- Always inflate the tires to the correct specified cold tire pressure values for the tires installed of the vehicle; see the tire inflation pressure label on the driver door jamb ⇒ *Tire inflation pressure*.
- Always inflate tires to the recommended and correct tire pressure before driving off.
- Driving with underinflated tires causes them to flex more, letting them get too hot, which can result in tread separation, sudden tire failure, and loss of control.
- Excessive speed and/or overloading can cause heat buildup, sudden tire failure, and loss of control.
- If the tire pressure is too low or too high, the tires will wear prematurely and the vehicle will not handle well.
- If the tire is not “flat” and you do not have to change the tire or wheel immediately, drive at reduced speed to the nearest service station to check the tire pressure and add air as required.
- When replacing tires or wheel rims on vehicles equipped with TPMS, always read and heed the information and all WARNINGS in the section “Tires and wheels” (see Index).



## WARNING

Failure to heed warning lights and instrument cluster text messages can cause the vehicle to break down in traffic and result in a collision and serious personal injury.

- Never ignore warning lights or text WARNINGS.
- Always stop the vehicle as soon as it is safe to do so.



## NOTICE

Failure to heed warning lights or text WARNINGS can result in vehicle damage.



## Tire Pressure Monitoring System (TPMS)

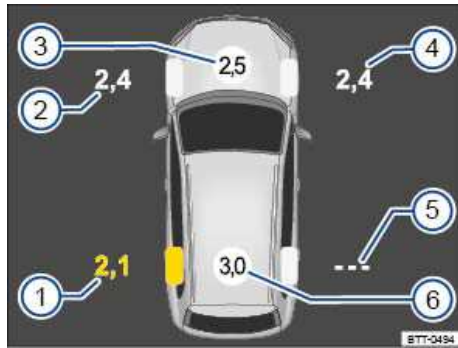

Fig. 116 Instrument cluster display: Current tire inflation pressures.

**⚠ Please first read and note the introductory information and heed the WARNINGS ⚠**

The Tire Pressure Monitoring System (TPMS) uses a pressure sensor in each wheel. Signals from the sensors are transmitted to the TPMS.

The TPMS checks the tire pressure of all 4 tires while you are driving and warns if there is a loss of pressure while the vehicle is moving. Pressure loss that is 25 % or more of the benchmark value programmed into the system is signalled by the indicator light (telltale), by acoustic warnings, and by text messages in the instrument cluster display.

If you mount tires of a different size than the factory installed tires, an authorized Volkswagen dealer or an authorized Volkswagen Service Facility must adjust the benchmark TPMS tire pressure to match the new tires. Without this adjustment, TPMS may not work correctly or at all.

The tire pressure recommended for the tires originally installed on the vehicle is on a sticker on the driver door jamb ⇒ *Tires and wheels*.

### Display in the instrument cluster

The display in the instrument cluster shows the vehicle with the actual and benchmark tire pressures of all 4 road wheels ⇒ fig. 116.

### Key to ⇒ fig. 116

Position number	Meaning
(1)	Tire pressure warning, left rear tire.
(2)	Current tire pressure, front left tire.
(3)	Benchmark pressure, front tires.
(4)	Current tire pressure, front right tire.

## Key to ⇒ fig. 116

Position number	Meaning
(5)	No data received, right rear tire.
(6)	Benchmark pressure, rear tires.

If the tire pressure is too low, the relevant tires and the respective readings are shown in yellow ⇒ fig. 116.

Each tire, including the spare (if provided), should be checked monthly when cold and inflated to the inflation pressure recommended by the vehicle manufacturer on the vehicle placard or tire inflation pressure label. (If your vehicle has tires of a different size than the size indicated on the vehicle placard or tire inflation pressure label, you should determine the proper tire inflation pressure for those tires.)

As an added safety feature, your vehicle has been equipped with a Tire Pressure Monitoring System (TPMS) that illuminates a low tire pressure telltale when one or more of your tires is significantly underinflated. Accordingly, when the low tire pressure telltale illuminates, you should stop and check your tires as soon as possible, and inflate them to the proper pressure. Driving on a significantly underinflated tire causes the tire to overheat and can lead to tire failure. Underinflation also reduces fuel efficiency and tire tread life, and may affect the vehicle's handling and stopping ability.

Please note that the TPMS is not a substitute for proper tire maintenance, and it is the driver's responsibility to maintain correct tire pressure, even if underinflation has not reached the level to trigger illumination of the TPMS low tire pressure telltale.

Your vehicle has also been equipped with a TPMS malfunction indicator to indicate when the system is not operating properly. The TPMS malfunction indicator is combined with the low tire pressure telltale. When the system detects a malfunction, the telltale will flash for approximately 1 minute and then remain continuously illuminated. This sequence will continue upon subsequent vehicle start-ups as long as the malfunction exists.

When the malfunction indicator is illuminated, the system may not be able to detect or signal low tire pressure as intended. TPMS malfunctions may occur for a variety of reasons, including the installation of replacement or alternate tires or wheels on the vehicle that prevent the TPMS from functioning properly. Always check the TPMS malfunction telltale after replacing one or more tires or wheels on your vehicle to ensure that the replacement or alternate tires and wheels allow the TPMS to continue to function properly.

### Collapsible spare tire

The collapsible spare tire has no tire pressure sensor. When the collapsible spare tire is mounted on the vehicle, the Tire Pressure Monitoring System (TPMS) indicator light will flash in the instrument cluster display. The TPMS continues to monitor the other 3 wheels.

### Tire storage

If the tires do not move for an extended period of time, the sensors will not transmit tire pressures to the system. This saves sensor battery life. When the ignition is switched on, the sensors transmit signals to the Tire Pressure Monitoring System (TPMS).

## WARNING

Incorrect tire pressure can cause sudden tire failure, loss of vehicle control and serious personal injury.

- After that, always make sure that all 4 tires are inflated to the correct tire pressure for the tires installed on the vehicle.
- See the tire pressure label ⇒ *Tire inflation pressure* and the Owner's Literature for recommended cold tire inflation pressure and other important information.
- When replacing tires or wheel rims on vehicles equipped with TPMS, always read and heed all of the information and WARNINGS ⇒ *Tire inflation pressure*.

## NOTICE

- The wheel electronics are attached to special aluminum valves on the wheels. These valves are screwed on rigidly. Never bend the valves “into position” when checking and adjusting tire pressure.
- Missing tire air valve caps could result in damage to the valves, as well as to the sensors on the Tire Pressure Monitoring System (TPMS). Therefore, make sure your valve caps conform to the specifications of those originally installed on the vehicle and that they are always tightly and properly screwed on to the valves. Do not use metallic valve caps.
- Do not use “comfort valve caps”, as these do not seal properly and could therefore cause damage to the sensors.
- When changing or rotating the tires, be careful not to damage the valves or sensors.
- The aluminum valves that are installed should be replaced after about 6 years of use due to aging of the rubber seals. The valves can be replaced when a tire is changed. Do not reuse aluminum valves after they are removed. They must be replaced. The tire pressure sensors can be reused.

# Storage areas

## Introduction

---

In this section you'll find information about:

- Storage compartment in the driver door
- Storage compartment in the upper front center console
- Storage compartment in the lower front center console
- Storage compartment in the front center armrest
- Storage compartment in the rear center console
- Glove compartment
- Storage compartment under the front seats
- Other storage compartments

Store only lightweight or small objects in storage compartments.

There may be a factory-installed **AUX-IN socket**, **Media Device Interface (MDI) / (MEDIA-IN)**, and a **12 Volt socket** located in the storage compartment in the front center armrest ⇒ [fig. 121](#).

The factory-installed **DVD drive**, may be located in the glove compartment ⇒ [fig. 124 \(2\)](#).

### More information:

- Passenger compartment
- Power locking and closing system
- Driver assistance systems
- Interior care and cleaning
- Introduction to the Infotainment System

### WARNING

Loose objects can be thrown around the inside of the vehicle when the vehicle is moving, especially during sudden maneuvers and hard braking. This can cause serious personal injuries and even make the driver lose control of the vehicle.

- Never let animals ride in the vehicle's open storage compartments, on top of the instrument panel, or on the shelf behind the rear seats.
- Never put hard, heavy or sharp objects in these places or in articles of clothing or bags in the passenger compartment.
- Always keep storage compartments closed while driving.

### WARNING

Objects in the driver footwell can prevent the pedals from moving freely. This can cause loss of vehicle control and increase the risk of serious personal injuries.

- Always make sure that nothing can interfere with the pedals.
- Always fasten floor mats securely to the floor.
- Never put floor mats or other floor coverings on top of already installed floor mats.
- Always make sure that nothing can fall into the driver footwell while the vehicle is moving.

## **! WARNING**

Some kinds of cigarette lighters can be lit unintentionally, or crushed causing a fire that can result in serious burns and vehicle damage.

- Always make sure that there are no lighters in the seat tracks or near other moving parts before adjusting the seats.
- Before closing a storage compartment, always make sure that no cigarette lighter can be activated, crushed, or otherwise damaged.
- Never leave a cigarette lighter in a storage compartment, on the instrument panel or in other places in the vehicle. Heat buildup in the passenger and luggage compartment of a parked vehicle can result in temperatures in the vehicle that are much higher than the outside temperatures, particularly in summer. High temperatures could cause the cigarette lighter to catch fire.

## **! NOTICE**

- The defroster heating wires or antenna in the rear window can be damaged by hard or sharp things on the shelf below the rear window.
- Do not keep any food, medicine, or other items sensitive to heat or cold in the vehicle. They can be damaged or made unusable by heat or cold.
- Things that are made of transparent materials (such as eyeglasses, magnifying glasses, or transparent suction cups on the windows) can magnify sunlight and damage the vehicle.



The ventilation slots between the rear window and the luggage compartment cover must not be blocked so that stale air can escape from the vehicle.

## **Storage compartment in the driver door**

---

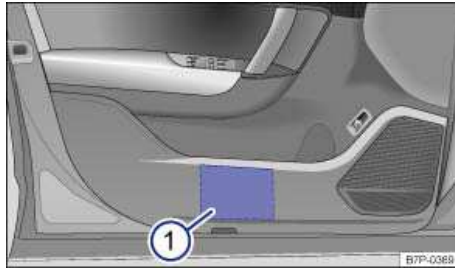

**Fig. 117** In the driver door: Storage compartment.

**! Please first read and note the introductory information and heed the WARNINGS !**

There is a storage compartment in the driver door. => [fig. 117 \(1\)](#).

## Storage compartment in the upper front center console

---



Fig. 118 In the upper front center console: Storage compartment.

**⚠ Please first read and note the introductory information and heed the WARNINGS ⚠**

To *open*, press the button on the cover ⇒ fig. 118 (arrow).

To *close*, push the cover down until it latches securely.

## Storage compartment in the lower front center console

---



Fig. 119 In the lower front center console: Storage compartment.

**⚠ Please first read and note the introductory information and heed the WARNINGS ⚠**

This storage compartment can be used for storing small items or other light objects.

To *open*, briefly press and release the storage compartment cover ⇒ fig. 119 (arrow).

To *close*, push the lid up until it latches.

**i** The lower front center console storage compartment has a 12 Volt socket ⇒ *Power outlets*.

## Storage compartment in the front center armrest

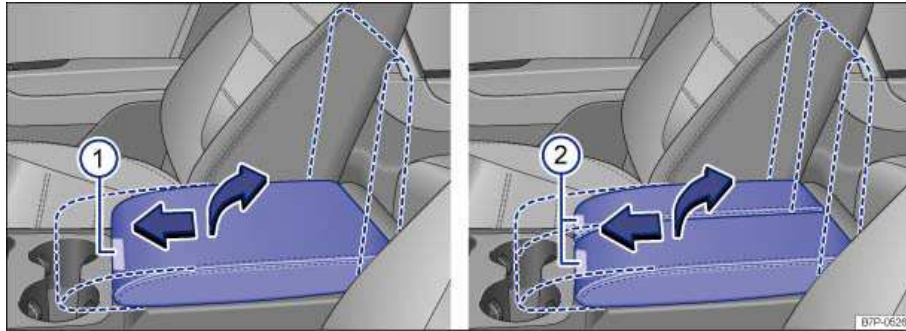

Fig. 120 In the front center armrest: Storage compartment.

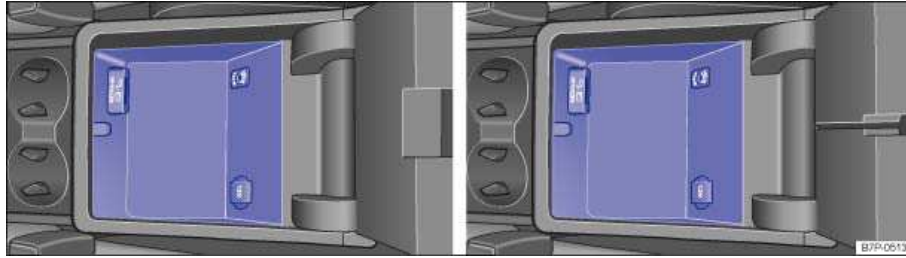

Fig. 121 In the front center armrest: Storage compartment.

**⚠ Please first read and note the introductory information and heed the WARNINGS ⚠**

The sections of a center armrest can be opened separately to access the storage compartment.

A MEDIA-IN ⇒ *MEDIA-IN multimedia jack*, AUX-IN ⇒ *External audio source connected via AUX-IN* and 12 Volt socket ⇒ *12 Volt sockets in the vehicle* may also be located in the storage compartment ⇒ fig. 121.

To *slide* (if applicable), press ⇒ fig. 120 (1) or (2) move the center armrest in the direction of the arrow ⇒ fig. 120.

To *open*, press button (1) or (2) and lift the center armrest section up completely in the direction of the arrow ⇒ fig. 51.

To *close*, push the center armrest down until it latches in place.

### **⚠ WARNING**

**The center armrest can restrict the driver's arm movement and cause crashes and serious personal injury.**

- Always keep storage compartments in the center armrest closed while driving.

## **⚠ WARNING**

**Never let a passenger, especially a child, ride on the center armrest. Improper seating position can increase the risk of serious personal injury in a crash.**

**i** There may be a 12 Volt-socket, a MEDIA-IN multimedia jack, or an AUX-IN-jack in the front center armrest stowage compartment.

- The MEDIA-IN multimedia jack lets you connect external devices to the Infotainment System ⇒ *MEDIA-IN multimedia jack*.

## **Storage compartment in the rear center console**

---



**Fig. 122** In the rear center console: Storage compartment.

**⚠ Please first read and note the introductory information and heed the WARNINGS**

A storage compartment is located in the rear center console ⇒ [fig. 122 \(1\)](#).

## **Glove compartment**

---

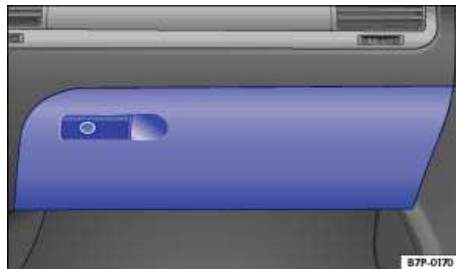

**Fig. 123** On the passenger side: Glove compartment.



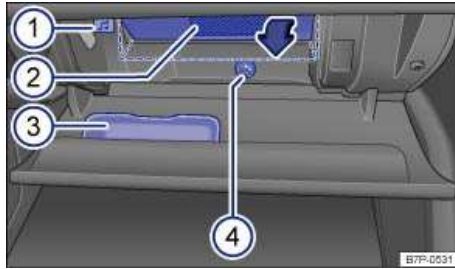

**Fig. 124** Inside the glove compartment.

**⚠ Please first read and note the introductory information and heed the WARNINGS ⚠**

Key to [fig. 124](#):

- (1) Release for fold-down compartment.
- (2) Compartment storage net for Owner's Manual (2) or within the fold-down compartment there may be a MEDIA-IN multimedia jack ⇒ *MEDIA-IN multimedia jack* or a DVD drive (HDD, SD) ⇒ *Inserting or removing data media*
- (3) Eyeglass compartment.
- (4) Vent.

### Opening and closing the glove compartment

If necessary, unlock the glove compartment. It is locked when the key slot is vertical.

- To *open*, pull the handle ⇒ [fig. 123](#).
- To *close*, push the lid up.

### Owner's Manual slot

The Owner's Manual ⇒ [fig. 124 \(2\)](#) is located in the storage net and should be kept there.

### Storage areas

Inside the glove compartment, there is an eyeglass compartment (3).

### MEDIA-IN multimedia jack or DVD drive (HDD, SD)

The fold-down compartment has either a MEDIA-IN multimedia jack ⇒ *MEDIA-IN multimedia jack* or a DVD drive with media center (HDD), and slots for SD cards ⇒ *Inserting or removing data media (2)*. Pull down the release (1) to open the fold-down compartment.

See ⇒ *Inserting or removing data media* for information and instructions on operating the DVD drive.

### Cooling the glove compartment

There is an air vent (4) in the back of the glove compartment. Cool air can be directed into the glove compartment if the air conditioner is on. Open or close the air vent by turning it.

## **⚠ WARNING**

**An open glove compartment door can increase the risk of serious injury during sudden braking or driving maneuvers or in a crash.**

- **Always keep the glove compartment closed while the vehicle is moving.**

## NOTICE

Keep the compartment with the DVD drive (2) closed while driving; otherwise, vibration may damage the DVD drive.

## NOTICE

In some vehicle models, design considerations have made it necessary to have openings in the glove compartment behind the Owner's Manual slot, for example. Small items may fall through these openings and get behind the instrument panel. This can cause unusual noises and damage the vehicle. Never put any small objects in the glove compartment for this reason.

## Storage compartment under the front seats

---

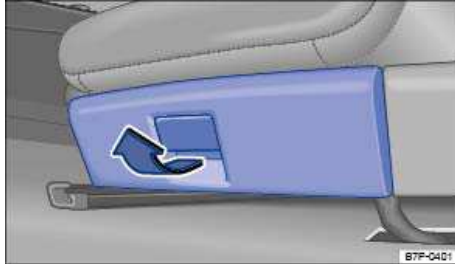

Fig. 125 Under the driver seat: Storage compartment.

☞ Please first read and note the introductory information and heed the WARNINGS ⚠

There is a storage compartment ⇒ fig. 125 under each front seat. A first aid kit can be stored in this storage compartment.

### Opening and closing the storage compartment

To **open**, pull the handle slightly in the direction of the arrow ⇒ fig. 125 and then push the cover down.

To **close**, fold the cover up and push in the direction of the front seat until it engages securely.

## WARNING

An open storage compartment can interfere with the pedals and cause accidents and severe personal injuries.

- Always keep the storage compartment closed when the vehicle is moving. Otherwise the storage compartment cover and other objects could get into the driver footwell and interfere with the pedals.

## Other storage compartments

---

☞ Please first read and note the introductory information and heed the WARNINGS ⚠

**Additional storage:**

- In the front and rear center console.
- In the door trim panels (front and rear).
- Shelf behind the rear seat backrest – only for light clothing or similar objects that do not interfere with visibility to the rear!
- **Coat hooks** on the center door jamb and on the overhead grab handles in the rear.
- **Shopping bag hooks** in the luggage compartment ⇒ *Luggage compartment*.
- An elastic strap in the right side trim of the luggage compartment.

 **WARNING**

**Clothes or other items on the shelf behind the rear seat backrest may limit visibility, and cause thereby causing accidents and severe personal injuries.**

- **Always hang clothes so that they do not limit visibility.**
- **Always use the built-in coat hooks only for lightweight clothing. Never leave any heavy or sharp-edged items in the pockets that may interfere with airbag deployment and can cause personal injury in a collision.**

## Cup holders

### Introduction

---

In this section you'll find information about:

Cup holders in the front center console

Cup holders in the rear center armrest

#### **Beverage bottle holders**

There is a place for bottles in the open storage bins on the driver and front passenger doors and holders for bottles in the open storage bins in the rear doors. The bottle volume must not exceed 49 oz (1.5 l) (front doors) and 16.9 oz (0.5 l) (rear doors) ⇒ .

#### **More information:**

- Interior care and cleaning

#### **WARNING**

Improper use of beverage holders can cause injuries.

- Never put hot drinks in the cup holders. During normal or sudden maneuvers, sudden braking or in a collision, hot liquid can be spilled and cause burns!
- Make certain that bottles or other items cannot fall into the driver's footwell while the vehicle is moving and interfere with the movement of the pedals.
- Never put heavy cups, food or other heavy items in the cup holders. Heavy items can fly through the passenger compartment in a crash and cause serious injury.
- Use the bottle holders only for standard beverage bottles holding no more than 16.9 oz (0.5 l).

#### **WARNING**

Hot or freezing temperatures in the passenger compartment can cause closed bottles to explode or break.

- Never leave closed bottles in a very hot or cold vehicle.

#### **WARNING**

Bottles and other things can fall into the driver's footwell and interfere with the pedals while driving.

- Make sure that bottles cannot fall into the driver's footwell during driving to avoid obstructing the pedals.
- Use the bottle holders only for standard beverage bottles holding no more than 49 oz (1.5 l) (front doors) and 16.9 oz (0.5 l) (rear doors).

## NOTICE

Never put open drinks in the cup holder when the vehicle is moving. The drinks can spill and damage the vehicle, including the electrical system.

### Cup holders in the front center console

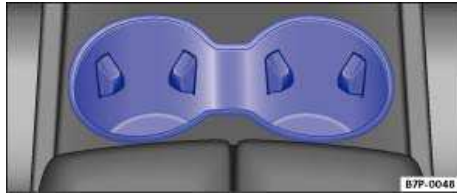

Fig. 126 In the front center console: Cup holders.

**ⓘ** Please first read and note the introductory information and heed the WARNINGS **⚠**

There are 2 cup holders in the front center console in front of the front center armrest ⇒ fig. 126.

### Cup holders in the rear center armrest

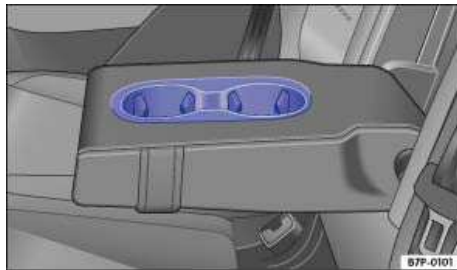

Fig. 127 In the rear center armrest: Cup holders.

**ⓘ** Please first read and note the introductory information and heed the WARNINGS **⚠**

There are 2 cup holders in the rear seat center armrest ⇒ fig. 127. Fold the center armrest down to use these cup holders.

## WARNING

Always keep the armrest folded up when the vehicle is moving to reduce the risk of injury.

- Never let anybody, especially children, ride on the rear center armrest or in the center position on the rear seat when the armrest is folded down. An improper seating position can increase the risk of serious injury in a crash.

**i** The insert is suitable for bottle volumes up to 16.9 oz. (0.5 liter).



Use the insert only in the cup holder in the rear center armrest. The insert cannot be installed in the cup holder in the front center console. Attempting to do so can scratch the surface.

## Power outlets

### Introduction

---

In this section you'll find information about:

- 12 Volt sockets in the vehicle
- 115 Volt outlet in the vehicle

Electrical devices can be connected to the vehicle sockets.

The connected devices must be in good working order.

#### **More information:**

- Storage areas
- Parts, accessories, repairs and modifications
- Consumer information

#### **WARNING**

**Improper use of electrical sockets and electrical devices may start a fire and cause severe personal injury.**

- **Never leave children unattended in the vehicle. Sockets and connected devices can be used when the ignition is switched on.**
- **If the connected device gets warm, immediately switch it off and disconnect the power supply.**

#### **NOTICE**

- **To help prevent damage to the electrical system, never connect any accessories such as a solar panel or vehicle battery charger to a 12 Volt socket.**
- **Only use accessories which have been tested for electromagnetic compatibility with a motor vehicle.**
- **To help prevent damage from voltage fluctuations, switch off all electrical consumers connected to the 12 Volt socket before switching the ignition on or off or starting the engine.**
- **Never connect devices to a 12 Volt socket that draw more than the maximum wattage the socket can supply. Drawing too much power can damage the vehicle electrical system.**



Please turn off the engine when you stop for any length of time.



The vehicle battery will drain if you use electrical equipment when the engine is not running.



Unshielded devices may interfere with radio reception or the vehicle's electrical system.



Operating electrical devices near the windshield-integrated antenna may interfere with AM radio reception.

## 12 Volt sockets in the vehicle

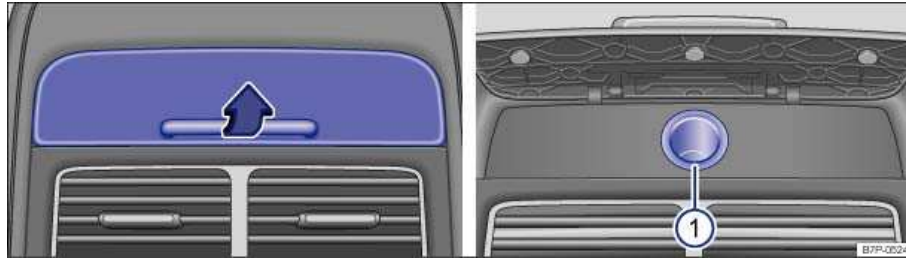

Fig. 128 Rear center console: Open cover for access to the 12 Volt socket.

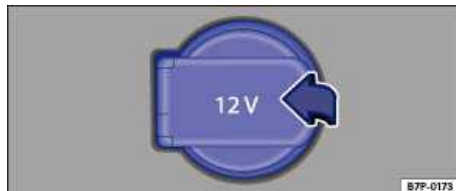

Fig. 129 Front center armrest storage compartment, luggage compartment, lower front center console: Opening the cover of the 12 Volt socket.

**⚠ Please first read and note the introductory information and heed the WARNINGS ⚠**

### Maximum power draw

Sockets	Maximum power draw
12 Volts	120 watts

The maximum power draw at any one socket must never be exceeded. Electrical devices should have information on them that says how much power they draw.

If 2 or more electrical devices are connected at the same time, the total power draw of all connected devices must never be more than 190 watts .

### 12 Volt socket

The 12 Volt socket works only when the ignition is switched on.

If the ignition is on but the engine is not running, the vehicle battery will be drained by any device that is plugged in and turned on. For this reason, never use the electrical sockets unless the engine is running.

To help prevent damage from voltage fluctuations, switch off all electrical devices connected to a 12 Volt socket before switching the ignition on or off or starting the engine.

The vehicle may have 12 Volt sockets at the following places:

- In the storage compartment in the front center armrest.
- In the rear center console ⇒ [fig. 128 \(1\)](#) or ⇒ [fig. 130 \(1\)](#).
- In the luggage compartment.



- In the storage compartment in the lower front center console.

#### Opening and closing the cover in the rear center console

- Reach into the recess from below ⇒ [fig. 128](#); fold the cover up in the direction of the arrow and hold it open.
- The cover is spring-loaded and closes when you let it go.

#### Opening and closing the 12 Volt socket covers in the front center armrest storage compartment, luggage compartment, lower front center console

- Grasp the cover on the side ⇒ [fig. 129](#) and open it in the direction of the arrow; hold it open.
- The cover is spring-loaded and closes when you let it go.

### ! NOTICE

- Follow the manufacturer's instructions for connected devices!
- Never exceed the maximum power consumption, or the entire vehicle electrical system may become damaged.
- 12 Volt socket:
  - Only use equipment that has been tested for electromagnetic compatibility and complies with applicable guidelines.
  - Never feed current into the socket with a solar panel, for example.

**i** Unshielded devices may interfere with radio reception or the vehicle's electrical system.

## 115 Volt outlet in the vehicle

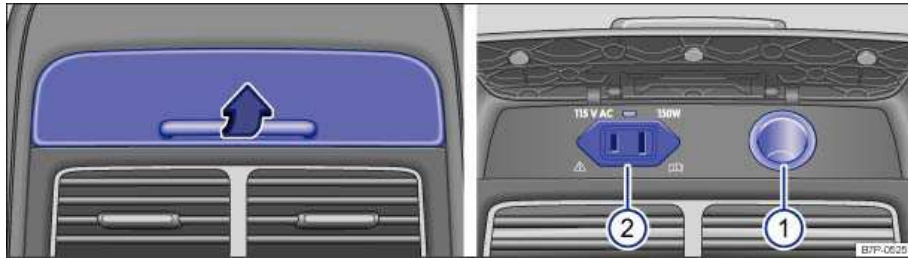

**Fig. 130** Rear center console: Open cover for access to the 115 Volt outlet (if equipped).

**⚠ Please first read and note the introductory information and heed the WARNINGS**

#### Maximum power draw

Outlet	Maximum power draw
⇒ <a href="#">fig. 130</a> (2)	

Outlet ⇒ fig. 130 (2)	Maximum power draw
115 Volts	150 watts (300 watts peak consumption)

The maximum power draw at any one outlet must never be exceeded. Electrical devices should have information on them that says how much power they draw.

#### 115 Volt outlet

The outlet can only be used if the engine is running .

*Connecting an electrical device:* Insert the plug as far as it goes into the outlet in order to unlock the integrated childproof lock. There is electricity in the outlet only after the childproof lock is unlocked.

---

#### LED display on the outlet

Green continuous light:	The child-proof lock is unlocked. The outlet is operational.
Red flashing light:	Malfunction, such as cutoff due to current overload or overheating.

#### Opening and closing the cover in the rear center console

- Reach into the recess from below; fold the cover up in the direction of the arrow and hold it open.
- The cover is spring-loaded and closes when you let it go.

#### Overheating cutoff

The inverter in the 115 Volt outlet shuts off automatically above a certain temperature. The shutoff prevents overheating in case of excessive power consumption of connected devices or at high ambient air temperatures. The inverter switches back on automatically after a cool-down period. Connected devices which were left switched on come back on again. For this reason, switch off connected electrical devices if the inverter switches off due to overheating.

 **DANGER**

**Improper use of the 115 Volt outlet can cause electrical shock, burns, and severe personal injury.**

- Never spill liquids on the socket.
- Never plug an adapter or an extension cord into the 115 Volt outlet. Otherwise, the integrated child-proof lock is switched off and the outlet is live.
- Never stick anything that conducts electricity, such as a knitting needle, into the contacts of the 115 Volt outlet.



## NOTICE

- **Follow the manufacturer's instructions for connected devices!**
- **Never exceed the maximum power consumption, or the entire vehicle electrical system may become damaged.**
- **115 Volt outlet:**
  - Do not connect devices or plugs which are too heavy, such as a grid power supply adapter or cord, directly onto the outlet.
  - Do not connect lamps containing fluorescent tubes.
  - Only connect devices to the outlet with voltage consistent with the voltage of the outlet.
  - For devices with a high starting current, the integrated over-current shutoff will prevent them from being switched on. In this case, disconnect the power supply from the device and reconnect after about 10 seconds.



Some devices may not work very well when connected to the 115 Volt outlet due to low wattage.



Unshielded devices may interfere with radio reception or the vehicle's electrical system.

## Safety information on Infotainment System

---

### WARNING

Driving on today's roads demands the full attention of the driver at all times. Driver distraction causes accidents, collisions and serious personal injury!

- Never let yourself be distracted when setting, adjusting, or using the Infotainment System, when using your mobile phone, or when operating the mobile phone controls.
- Always drive attentively and responsibly. Use the Infotainment system, your mobile phone, and the mobile phone controls only if road, traffic, and weather conditions permit and you will not be distracted from your driving.
- If you cannot use the Infotainment System, your mobile phone, or the mobile phone controls safely while driving, wait until later or find a safe spot where you can pull off the road and park the vehicle.
- Always set sound volume levels so that you can clearly hear horns, sirens, and other warning sounds outside the vehicle.
- Setting the sound volume too high may damage your hearing. This applies even if you are exposed to high volumes for short periods only.

### WARNING

The volume level may suddenly get louder change when you switch media source or connect a new audio source.

- Always lower the base volume before switching media source or connecting a new audio source.

### WARNING

Driving recommendations and traffic symbols displayed by the navigation system may differ from the current traffic situation.

- Traffic signs and traffic regulations have priority over the recommendations and displays provided by the navigation system.
- Always adjust your speed and driving style to road, traffic, weather, and visibility conditions.

### WARNING

External devices that are loose in the vehicle or not properly secured could be thrown around the interior and cause injuries during a sudden driving or braking maneuver, or in a crash.

- Never put or attach an external device on a door, on the windshield or above or near to the areas marked "AIRBAG" on the steering wheel, the instrument panel and the seat backrests, or between these areas and the vehicle occupants. External devices could cause serious injury in an accident, especially when the airbags inflate.

 **WARNING**

Connecting cables of external devices may obstruct visibility through the windshield or other windows.

- Route cables so as not to interfere with the driver.

 **WARNING**

Opening a CD or DVD player's housing can lead to injuries from invisible laser radiation.

- Always have CD or DVD players repaired only by a qualified workshop.

 **NOTICE**

Improper insertion or insertion of an improperly fitting memory card can damage the locking mechanism in the memory card slot.

- Pay attention to the proper insertion position ⇒ page 269, *Media mode: Introduction*.
- Excessive pressure can destroy the locking mechanism in the memory card slot.
- Only use suitable memory cards.

 **NOTICE**

- When inserting and removing CDs and DVDs, always hold them at right angles to the front of the unit. Inserting or removing them at an angle to the DVD drive may lead to scratching.
- Inserting a second CD or DVD while a CD or DVD is inserted or is being ejected can destroy the DVD drive. Always wait until the data storage device is completely ejected.

 **NOTICE**

Any foreign objects attached to a data medium and non-round data storage devices can damage the DVD drive.

- Only clean 12-cm standard CDs or DVDs should be used!
  - Do not attach stickers or other items to the data storage device. Stickers may peel off and damage the drive.
  - Do not insert 8-cm single CDs or non-round CDs (shaped CDs) or DVDs.
  - Do not insert DVD-Plus, Dual Discs and Flip Discs, as these are thicker than standard CDs.

## Operation basics

### Introduction

---

In this section you'll find information about:

Controls

Switching on or off

Adjusting the base volume

Function keys on screen

Browsing lists

Moving objects and displays on the screen

Using slider  to change settings

Input windows with on-screen keyboard

Additional displays and display options

Due to changes to its settings, some aspects of the unit's operation may differ from the descriptions given in this manual. For this reason, Volkswagen recommends that you reset the unit to its **factory settings** the first time you use it

Before using the unit for the first time, carry out the following steps. This will enable you to use the unit safely and make full use of the functions it provides:

#### **Before using**

---

- ✓ Observe safety notes  ⇒ *Safety information on Infotainment System.*
  - ✓ Familiarize yourself with the controls of the Infotainment System.
  - ✓ Reset the unit to its original condition (factory settings) ⇒ *System settings.*
  - ✓ Use data storage devices suitable for Media mode ⇒ *Data media and file requirements.*
- 

#### **More information:**

- Safety information  for Infotainment System

### NOTICE

**Lightly pressing the buttons or briefly pressing the touchscreen is sufficient to operate the unit.**

 Not all listed function keys and functions may be available due to the device software used in your market. The equipment is not faulty if a function key is missing from the screen.

 Volkswagen recommends using the Volkswagen cleaning cloth for cleaning the screen. Replacement cloths are available from your Volkswagen dealership.

 After making entries, the Infotainment System may need a few seconds for processing and may not respond to operation of controls. Nevertheless, do not continue to operate the unit, because oper-

ating sequences that have been input are “memorized” and “processed” in succession once the background processes have been completed.

**i** Due to country-specific legal requirements, some functions are not selectable on the screen above a certain driving speed.

**i** Using a mobile phone in the vehicle may cause noise from the vehicle speakers.

**i** Some countries may have restrictions regarding the use of Bluetooth devices. Information can be obtained from the local authorities.

## Controls

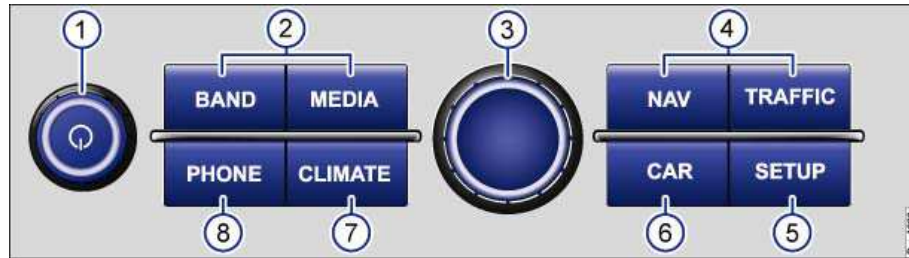

Fig. 131 Overview of rotary/push knobs and the Infotainment buttons.

**⚠ Please first read and heed the WARNINGS ⚠ note the introductory information and heed the WARNINGS ⚠**

The labelled **Infotainment buttons** for accessing the different feature areas are operated by *pressing*. In this manual, the Infotainment buttons are shown as a button symbol with blue writing (such as **MEDIA**).

The Infotainment System screen is located above the Infotainment buttons. The screen is a touchscreen that is operated by touching with your finger or by touching the surface of the screen in another way.

- (1) **Rotary/push knob.**
  - *Press* to switch on or off
  - *Turn* to adjust the basic volume
- (2) **Infotainment buttons for selecting an audio or video source.**
  - **BAND** / **RADIO**: Switches to radio mode
  - **MEDIA**: Switches to media mode (audio or video source)
- (3) **Adjustment knob:** The feature depends on the operating mode.
  - *Turn* to select menu options in long lists and *press* to call up the selected option (for instance, select a station from the station list)
  - *Turn* to change some settings (such as map scale).
  - During active route guidance, *press* to repeat a navigation announcement
- (4) **Infotainment buttons for accessing the navigation functions.**
  - **NAV**: Open the *Navigation* main menu
  - **TRAFFIC**: Displays stored traffic reports
- (5) **SETUP** Infotainment button for accessing the Infotainment settings.

- (6) **CAR** Infotainment button for accessing the vehicle settings
- (7) **CLIMATE** Infotainment button for accessing the air conditioning settings
- (8) **PHONE** Infotainment button<sup>4</sup> for accessing the telephone functions

## Switching on or off

ⓘ Please first read and heed the **WARNINGS** ⚠ note the introductory information and heed the **WARNINGS** ⓘ

To switch the unit on or off manually, briefly press the ⌚ rotary/push knob ⇒ fig. 131 (1).



The system starts after being switched on. The most recently played audio source is played at the volume that was last set.

ⓘ The Infotainment System is permanently linked to the vehicle. It will not work in another vehicle.

ⓘ If the vehicle battery was disconnected, please switch on the ignition before switching on the device.

## Adjusting the base volume

ⓘ Please first read and heed the **WARNINGS** ⚠ on page 229, note the introductory information and heed the **WARNINGS** ⓘ on page 231.

Function	Response
Increase volume.	Turn the volume control ⌚ ⇒ fig. 131 (1) clockwise or press the button  on the multi-function steering wheel ⇒ page 5 ⇒ page <b>Error! Bookmark not defined..</b>
Reduce volume.	Turn the volume control ⌚ counterclockwise or press the  button on the multi-function steering wheel.

To mute the unit, turn the volume control ⌚ counterclockwise all the way (display: 🔇). Any media source being played will stop.

In vehicles without mobile phone package, the unit can be muted with the **PHONE** Infotainment button.

Changes to the volume are indicated by a “bar” on the Infotainment System screen. During this time the Infotainment System cannot be operated.

It is possible to preset certain volume settings and adjustments in the Infotainment System

<sup>4</sup> The current audio source is muted in vehicles without mobile phone package.



## **! WARNING**

Using the Infotainment System while the vehicle is in motion can take your attention off the road and lead to accidents and serious personal injuries.

- Always drive attentively and responsibly.
- Always set volume levels so that you can clearly hear horns, sirens, and other warning sounds outside the vehicle.
- Setting the volume too high may damage your hearing. This also applies if you are exposed to high volumes for short periods only.

## **! WARNING**

The volume may suddenly get louder when you switch media source or connect a new audio source.

- Always lower the volume before switching media source or connecting a new audio source.

## **! NOTICE**

Excessively loud or distorted playback can damage the vehicle speakers.

**i** If the base volume on the Infotainment System has been considerably increased to play a certain audio source, lower the volume again before switching to another audio source.

## Function keys on screen

---

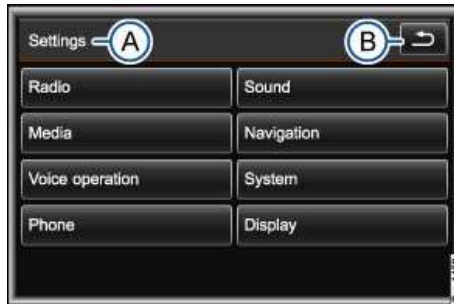

Fig. 132 Setup main menu (SETUP).

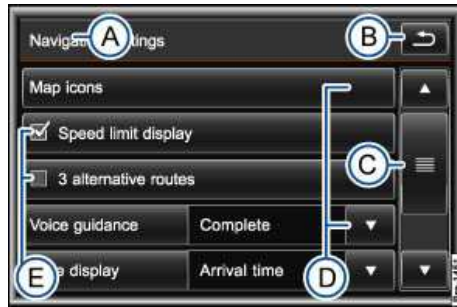



Fig. 133 Navigation settings.

**⚠ Please first read and heed the WARNINGS ⚠ note the introductory information and heed the WARNINGS ⚠**

Active areas of the screen that call up a certain function are called "function keys". These buttons are operated by *briefly pressing* the screen or by *pressing and holding*. Function keys are described in the manual as "function key" and with the  button symbol.

Function keys start functions or open submenus. In submenus the name of the currently selected menu is displayed in the title bar ⇒ fig. 132 (A).

Press the  function key (B) in the title bar to switch back from a submenu.

If a function key on the screen has a gray background, it is currently disabled (such as in fig. 138).

### Pop-up window

The selected setting is displayed in an "option window" behind some function keys. The option window is indicated by an arrow ▼ ⇒ fig. 133 (D).

If you press one of these function keys, a pop-up window opens, displaying all the possible setting options. When the desired setting is pressed, the pop-up window closes and the modified setting is displayed in the  option window.

If you press the  function key in the **Options** pop-up window, the pop-up window will close without changes being made.

### Starting functions or activating via "check boxes"

Some functions are started and stopped by pressing a button, for example the scan feature. Other functions and displays are permanently activated or deactivated and are controlled via check boxes (E).

A check mark in a check box  indicates that the feature is activated, an empty check box , that it is deactivated.

Any functions enabled by check box can only be disabled by pressing the respective function key again.



Fig. 134 List for selecting audio files for import.



Fig. 135 Station list in radio mode.

⚠ Please first read and heed the WARNINGS ⚠ on page 229, note the introductory information and heed the WARNINGS ⚠ on page 231.

### Selecting items in lists and searching lists (scrolling)

If there are more items available in a list view than can be displayed on the screen, a scroll bar is displayed on the right of the screen ⇒ fig. 133.

- *Browsing lists line-by-line:* press the ▲ or ▼ function key briefly.
- *Browsing lists page-by-page:* briefly press the screen above or below the scroll marker ⇒ fig. 133 (C). **OR:** Briefly press the ▲ or ▼ function keys ⇒ fig. 134.
- *Browsing long lists quickly page-by-page:* press and hold the screen above or below the scroll marker.
- *To quickly scan through a long list,* place your finger on the scroll marker and move it over the screen *without losing contact.* When the desired position is reached, lift the finger from the screen.

### Selecting options in long lists with the setting knob (3)

You can also use the setting knob to browse through simple lists without additional function keys, which are provided for selecting an entry ⇒ fig. 135.

- Turn the setting knob to move a selection box and browse through the list.
- Press the setting knob to call up the selected entry.

## Moving objects and displays on the screen

---



Fig. 136 Destination on map.

☐ Please first read and heed the WARNINGS ⚠ note the introductory information and heed the WARNINGS ⚠

Some objects and displays can be moved on the screen. For example, you can move the map display behind the crosshair to select a destination from the map ⇒ fig. 136.

- Lightly press your finger against the movable object on the screen (in on the map).
- Move your finger across the screen *without losing contact*. The object will follow the movement.
- When the desired position is reached, lift the finger from the screen.

Some objects can only be moved within a predefined range, such as the slider ☐ in a setting bar ⇒ fig. 137.

## Using slider ☐ to change settings

---

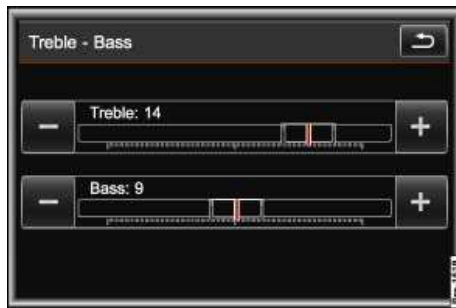

Fig. 137 Sound settings.

☐ Please first read and heed the WARNINGS ⚠ note the introductory information and heed the WARNINGS ⚠

Moving a slider ☐ across its scale adjusts a setting ⇒ fig. 137.

- Place your finger on the slider ☐ and drag it across the screen *without losing contact*.
- **OR:** Tap the ☐ or ☐ function key on the screen to move the slider in steps.

- **OR:** Press a point on the scale either side of the slider. The slider will then ☐ “jump” straight to the selected point.

## Input windows with on-screen keyboard

---



Fig. 138 General view of an input window with on-screen keyboard.

☐ Please first read and heed the **WARNINGS** ⚠ note the introductory information and heed the **WARNINGS** !

Input windows with on-screen keyboard are used for functions such as entering an entry name, selecting a destination address or entering a search term for searching in long lists.

Not all input windows contain all of the function keys listed here.

Subsequent chapters only explain those functions that differ from the general view described here.

The input line with the cursor is located on the left in the top line of the screen. All inputs are displayed here.

### Input screens for “free text input”

An input window for free text entry allows any letter, number and special character to be entered in any combination.

Touching the **OK** function key accepts the currently displayed character sequence.

### Input windows for selecting a saved entry (such as selection of a destination address)















It is only possible to select a sequence of letters, numbers and special characters that matches a stored entry ⇒ fig. 138.

Every time a character is entered, a destination corresponding to the specifications is proposed in the input line (here: **BRANDAUSRASSE**). When terms are made up of more than one word, it is necessary to enter the space as well (such as in **SANKT AUGUSTIN**).

If fewer than 99 entries are available, the number of remaining entries is displayed after the input line (here: **14**). Pressing this function key displays these remaining entries in a list. When fewer than six destinations are available, the list opens automatically.

### Overview of function keys

Function keys	Action and effect
---------------	-------------------

Function keys	Action and effect
Containing letters and digits	Press to insert the character in the input line.
Containing letters and 	Press and hold to open a pop-up window with special characters based on this letter. Press the desired character to enter it. Some special characters can also be written out (such as “AE” for “Ä”).
	Pressing briefly highlights <b>all</b> function keys for which special characters are available. Press a function key to open the pop-up window to select a special character.
	Press to switch between upper and lower case.
 OR: 	Press to open the input window for numbers and special characters or to go back to the letter input window.
	Press to enter a space.
 and 	Press to move the cursor to the left or right in the input line.
	Press to accept the suggestion in the input line and close the input window.
	Press to delete characters in the input line from right to left.
	Press to open the list of remaining items that match the text you have entered.
 (or here: 	Displays the number and opens the list of entries that are still available corresponding to the specifications.
	Press to close the input window.

## Additional displays and display options

---

⚠ Please first read and heed the **WARNINGS** ⚠ note the introductory information and heed the **WARNINGS** ⚠

The displays appearing on the screen can vary depending on the settings, and may differ from those described here.

If the **time display** is activated in the system settings, the time will appear in the status bar within a few seconds in radio or audio mode. The station or track will then be displayed above or below it. This display feature can be deactivated

All displays appear only after the Infotainment System has completed start-up.

The screen can be switched off in some menus.

- Touch the **Extras** function key.
- In the pop-up window, press the **Display off** function key.
- To switch on again, press any Infotainment button or touch screen.

# Voice operation

## Introduction

---

In this section you'll find information about:

- Use of voice operation
- Notes on voice operation
- Voice operation settings

Some functions can be called up with voice commands.

It is not possible to control the setting menus (**SETUP**) with voice commands.

During voice operation, voice guidance is issued as a help for operation. This can be output in long or short dialog

### Supported languages

Voice operation is available only for the languages that can be selected in the Infotainment System.

You need to use the language set in the Infotainment System for voice operation.

- Set the preferred language in the **System settings** menu

### More information:

- Safety information  for Infotainment System
- Basic information on use



Voice operation is not possible during parking maneuvers.

## Use of voice operation



---

 **Please first read and heed the WARNINGS and note the introductory information**

### Starting and stopping the voice operation feature

- Briefly press the  button on the multi-function steering wheel to activate voice operation

The voice operation is activated with a signal tone. A help menu with the most important voice commands for the current operating area is then displayed (such as media mode). Voice guidance provides assistance with the subsequent voice dialog.

- Say the required voice command and follow the voice dialog.
- Voice operation is ended once an action is completed.
- To end voice operation manually, press and hold the  button on the multi-function steering wheel until the corresponding confirmation is given or press the  function key on the screen.

The individual entries for voice operation are numbered in the list views. The numbers are displayed on the left in the function keys. Speaking a number opens or activates the corresponding entry.

Often, the same feature can be called up using different voice commands. If in doubt, simply try out a voice command.



### Help for voice operation feature

Help for voice operation should be activated and listened to the first time you use it.

The help for voice operation explains basic operation and demonstrates the most important voice commands.

- Briefly press the  button on the multi-function steering wheel.
- Say the voice command in the language set in the Infotainment System.

### Language: voice command

---

---

German: Hilfe Sprachbedienung

---

English: Voice operation help

---

French: Aide Système de commande vocale

---

Spanish: Ayuda Manejo por voz

---

Italian: Aiuto sistema di comando vocale

---

Portuguese: Ajuda do comando por voz

---

Dutch: Help spraakbediening

---

Russian: Справка по системе голосового управления

- Follow the subsequent explanations and instructions in the voice dialog.

### Control during voice dialog

While voice guidance is being provided by the Infotainment System, the microphone symbol “not active” (without the 3 lines) is shown on the instrument cluster display and on the Infotainment System screen.

- Briefly press the  button on the multi-function steering wheel to interrupt voice guidance from the Infotainment System and immediately say the next voice command.

You can only say a voice command when the  symbol “active” is displayed.

If a voice command is spoken incorrectly or incompletely and no action has been started as a result, the voice command can be repeated. The  symbol remains “active”.

- Briefly press the  button on the multi-function steering wheel to repeat the voice command.



### Recording name tags

A name tag can be recorded as a voice command in some menus via the voice operation. Follow the instructions from the voice dialog. Avoid loud noises in the background when recording voice inputs.



Some voice commands are only available if the unit is in the right operating area.

 Display of the help menus for the individual operating areas can be disabled

 If a voice command has been misunderstood several times, it may be sensible to terminate voice operation manually by pressing the  button longer and to then start again.

## Notes on voice operation

---

 Please first read and heed the **WARNINGS**  and note the introductory information

Please note the following points to ensure that the voice operation feature works properly:

- If possible, speak slowly and clearly. Indistinct words and numbers, or numbers with *swallowed* syllables cannot be recognized by the system.
- Say the telephone numbers only in single digits.
- Speak at a normal volume without exaggeration or long pauses.
- Avoid background noise, such as conversations in the vehicle. Close all windows, doors and the sunroof.
- Do not point the flow of air from the vents towards the vehicle roof.
- Speak a little louder at higher speeds.

## Voice operation settings

---

 Please first read and heed the **WARNINGS**  and note the introductory information

- Press the **SETUP** Infotainment button ⇒ fig. 131.
- Press the **Voice operation** function key.

### Function key: Effect

---

---

 **Display commands**: Voice commands for the current operating area are displayed on the screen when you activate voice operation.

---

 **Short dialog**: Voice guidance for voice operation is provided in a short dialog. Some additional supporting voice guidance from the long dialog remains.

---

 **Input signal**: Input signal for confirming a voice command is switched on.

---

**Individual speech training**: Train the voice operation for your voice to improve the recognition accuracy. Follow the instructions on the screen for individual speech training.

---

## Function key: Effect

---

**Volume:** Set volume of voice guidance for voice operation (Changing settings).

---

**Delete all name tags:** All recorded name tags will be deleted

### **WARNING**

Driving on today's roads demands the full attention of the driver at all times. Driver distraction causes accidents, collisions and serious personal injury!

- Never let yourself be distracted when setting, adjusting, or using the Infotainment System, when using your mobile phone, or when operating the mobile phone controls.
- Always drive attentively and responsibly. Use the Infotainment system, your mobile phone, and the mobile phone controls only if road, traffic, and weather conditions permit and you will not be distracted from your driving.
- If you cannot use the Infotainment System, your mobile phone, or the mobile phone controls safely while driving, wait until later or find a safe spot where you can pull off the road and park the vehicle.
- Always set sound volume levels so that you can clearly hear horns, sirens, and other warning sounds outside the vehicle.

## Sound, menu and system settings (SETUP)

### Introduction

---

In this section you'll find information about:

- Settings main menu (SETUP)
- Sound and volume settings
- System settings
- Display settings

Press the **SETUP** Infotainment button for the choice of settings menus ⇒ [fig. 131](#).

Infinitely adjustable settings are made with a slider 

In the **System settings** menu, you can reset individual areas of the Infotainment System or the complete Infotainment System to the **factory settings**.

#### More information:

- Safety information  for Infotainment System
- Basic information on use



#### WARNING

**Driving on today's roads demands the full attention of the driver at all times. Driver distraction causes accidents, collisions and serious personal injury!**

- **Never let yourself be distracted when setting, adjusting, or using the Infotainment System, when using your mobile phone, or when operating the mobile phone controls.**
- **Always drive attentively and responsibly. Use the Infotainment system, your mobile phone, and the mobile phone controls only if road, traffic, and weather conditions permit and you will not be distracted from your driving.**
- **If you cannot use the Infotainment System, your mobile phone, or the mobile phone controls safely while driving, wait until later or find a safe spot where you can pull off the road and park the vehicle.**
- **Always set sound volume levels so that you can clearly hear horns, sirens, and other warning sounds outside the vehicle.**

## Settings main menu (SETUP)

---



Fig. 139 Setup main menu (SETUP).

Please first read and heed the **WARNINGS** ⚠ note the introductory information and heed the **WARNINGS** ⚠

- Press the **SETUP** Infotainment button to open the **Settings** main menu.
- To adjust the settings for a certain feature, press the appropriate function key.

You can always go back to the previously active menu from the **Settings** main menu by pressing the  function key.

If the check box in a function key is checked , the feature is switched on

This chapter describes sound, system and display settings.

Descriptions of settings for other functions can be found in the chapters listed below.

### Function key: settings menu

---

---

**Radio**: Radio settings

---

**Media**: Track display setting

**DVD settings**: DVD settings

---

**Voice operation**: Voice operation settings

---

**Telephone**: Telephone settings

---

**Directory**: Directory settings

---

**Sound**: Sound and volume settings

---

**Navigation**: Navigation settings

---

## Function key: settings menu

---

**System**: System settings

---

**Display**: Display settings

---

**Bluetooth**: **Bluetooth settings**

## Sound and volume settings

---

 Please first read and heed the **WARNINGS**  note the introductory information and heed the **WARNINGS** 

- Press the **SETUP** Infotainment button.
- Press the **Sound** function key.

Changes made in settings menus are automatically applied once the menu is closed.

## Function key: Effect

---

**Dynaudio Confidence**: Dynaudio-Confidence® settings

---

**Treble - Bass**: Changing sound character. Change settings by moving the slider .

---

**Balance - Fader**: Changing the sound focus

---

**Volume**: Volume settings.

**Voice guidance**: Set output volume for navigation announcements during route guidance.

**Reduced audio volume** Set how much the volume for other audio sources should be reduced during a navigation announcement. The current audio source is set to the reduced volume while you change the settings.

**Parking distance warning system**: Set output volume for beeping signals (front and rear).

## Function key: Effect

---

**Reduced audio volume**: Set how much the volume for other audio sources should be reduced while a beeping signal sounds. The current audio source is set to the reduced volume while you change the settings.

**Telephone**<sup>5</sup>: Set output volume for telephone calls in the vehicle.

---

**Speed-dependent volume adjustment**: If the speed-dependent volume (GALA) is activated, the audio volume is automatically raised as the vehicle speed increases.

When speed-dependent volume is switched on in vehicles with Dynaudio Confidence<sup>®</sup>, the volume of individual frequencies is automatically raised or reduced depending on the road noise caused by the rising vehicle speed. This “reduces” the road noise in the vehicle.

### Changing the sound focus (balance and fader) using the vehicle diagram

- Press the **Balance - Fader** function key.

The crosshair in the vehicle diagram shows the current sound focus in the vehicle interior.

- Place your finger on the crosshair and, *without lifting it off*, drag it across the screen. Lift your finger off the screen once the sound focus is in the required position (Moving objects).
- **OR**: Press the point in the interior view where you want the sound focus to be.
- **OR**: Move the sound focus step by step by pressing the arrow buttons on the left of the screen.

Press the function key between the arrow buttons to return the sound focus to the center of the interior view.

### Dynaudio Confidence<sup>®</sup>

Additional settings are available if the vehicle is equipped with the RNS 850 and Dynaudio.

- In the **Sound settings** main menu, press the **Dynaudio Confidence** main menu.

## Function key: Effect

---

**Dynaudio Presets**: Set sound profile and tone color.

**Individual**: Move slider  to change setting for tone color.

---

<sup>5</sup> Only when a mobile phone or a SIM card is connected to the Infotainment System ⇒ page 360.

## Function key: Effect

---

**Authentic**, **Soft**, **Dynamic**, **Speech**: Press to select sound profile.

---

**Surround**: Set level of surround effect.

## System settings

---

Please first read and heed the WARNINGS  note the introductory information and heed the WARNINGS 

- Press the **SETUP** Infotainment button.
- Press the **System** function key.

## Function key: Effect

---

**Language**: Press to select the desired language for text and voice output.

---

**Units**: Set units for displays in the vehicle (such as for estimated driving time and distance in navigation displays).

---

**Time/Date**: Set time and date

---

**Factory default settings**: Reset the unit to the original settings

---

**Version information**: Shows the unit's hardware and software version.

### Setting time and date

Press **Time / Date** in the **System Settings** main menu.

## Function key: Effect

---

**Show clock**: The time is displayed in the status bar. Clear check box  to switch off

---

**Time source**: Set time source.





## Function key: Effect

---

**GPS:** Use **Time zone GMT** to select the time and date. **Time** and **Date** are then disabled for manual entry.

**Manual:** Time and date can be entered manually by pressing **Time** and **Date**. **Time zone GMT** is then disabled.

---

**Time:** Set the time by pressing the arrow buttons  or  and confirm change with **OK**.



---

**Time zone GMT:** Press the  or  arrow buttons to select the time zone.

---

**Time format:** Press to select the format for the time display (12 or 24-hour).

---

**Date:** Set the date by pressing the arrow buttons  or  and confirm change with **OK**.

---

**Date format:** Press to set format for displaying the date.

---

### Resetting to factory settings

Resetting to the original settings **will erase entered data, destinations and settings**, depending on the selection made.

- Press **Factory default settings** in the **System settings** main menu.
- In the **Factory settings** selection menu, select the check boxes on the left of the entries that you want to delete.
- Press the **Reset** function key.
- Also accept the confirmation dialog with the **Reset** function key.



Music files stored on the unit's hard drive must be deleted manually ⇒ page 284.



It is important that the correct date and time are set in the vehicle to ensure all Infotainment Systems work properly.

## Display settings

---

 Please first read and heed the **WARNINGS**  the introductory information and heed the **WARNINGS** 

- Press the **SETUP** Infotainment button.
- Press the **Display** function key.

### Function key: Effect

---

---

**Brightness**: Set brightness level of screen.

---

**Confirmation tone**: Switch the confirmation tone for pressing of a function key on.

---

**Day/night**: Define map display settings.

**Day**: Map view remains in bright daytime design.

**Night**: Map display remains in dark night time design.

**Automatic**: Daytime or night time design of the map view changes as the low beam headlights are switched on and off.

## System settings (CAR)

### Introduction

---

In this section you'll find information about:

Settings main menu (CAR)

Hybrid menu

Assist systems menu

Settings menu

Service menu

Press the  Infotainment button for the choice of settings menus.

#### More information:

- Safety information  for Infotainment System
- Basic information on use

#### WARNING

**Driving on today's roads demands the full attention of the driver at all times. Driver distraction causes accidents, collisions and serious personal injury!**

- Never let yourself be distracted when setting, adjusting, or using the Infotainment System, when using your mobile phone, or when operating the mobile phone controls.
- Always drive attentively and responsibly. Use the Infotainment system, your mobile phone, and the mobile phone controls only if road, traffic, and weather conditions permit and you will not be distracted from your driving.
- If you cannot use the Infotainment System, your mobile phone, or the mobile phone controls safely while driving, wait until later or find a safe spot where you can pull off the road and park the vehicle.
- Always set sound volume levels so that you can clearly hear horns, sirens, and other warning sounds outside the vehicle.

## Settings main menu (CAR)

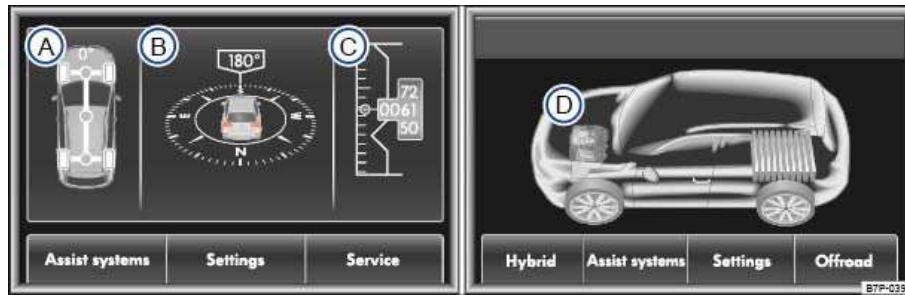

Fig. 140 Infotainment system with navigation: Settings main menu (CAR).



Fig. 141 Infotainment system without navigation: Settings main menu (CAR).

**⚠ Please first read and note the introductory information and heed the WARNINGS ⚠**

- (A) Shows steering angle.
- (B) Compass view with the current direction of travel.
- (C) Display showing the current altitude.
- (D) Energy flow to the high-voltage battery (battery charge)

Open settings main menu (CAR):

- Switch on the ignition.
- Press the **CAR** Infotainment button.
- To adjust the settings for a certain feature, press the appropriate function key.

### Function key: Effect

---

**Assist systems**: Assist systems menu

---

**Settings**: Settings menu

---

**Service**: Service menu

---

## Function key: Effect

---

**Hybrid**: Hybrid menu

---

**Offroad**: Shows the steering angle ⇒ [fig. 140 \(A\)](#), the compass view with the current direction of travel [\(B\)](#) and the current altitude [\(C\)](#).

You can always go back to the previously active menu from the main menu by pressing the  function key.

If the check box in a function key is checked , the feature is switched on

## Hybrid menu

---

 **Please first read and note the introductory information and heed the WARNINGS** 

- Switch on the ignition.
- Press the **CAR** Infotainment button.
- Tap the **Hybrid** function key on the screen.

Pressing the  function key always takes you back to the previously active menu.

The feature is enabled when the function key check box  is checked.

## Function key: Effect

---

**Energy flow**: Energy flow **to** the high-voltage battery (battery charge).

---

**On-board computer**: Display of different vehicle values for example average fuel economy and consumption.

---

**Fuel economy**: Display of fuel consumption and the regeneration of the high-voltage battery when driving.

Changes made in settings menus are automatically applied once the menu is closed.

## Assist systems menu

---

 **Please first read and note the introductory information and heed the WARNINGS** 

- Switch on the ignition.
- Press the **CAR** Infotainment button.
- Tap the **Assist systems** function key on the screen.

Pressing the  function key always takes you back to the previously active menu.

The feature is enabled when the function key check box  is checked.

### Function key: Effect

---

**Rain sensor**: Activate or deactivate rain sensor

---

**Parking distance warning system**: Settings for parking distance warning system

Changes made in settings menus are automatically applied once the menu is closed.

### Settings menu

---

**Please first read and note the introductory information and heed the WARNINGS** 

- Switch on the ignition.
- Press the **CAR** Infotainment button.
- Tap the **Settings** function key on the screen.

Pressing the  function key always takes you back to the previously active menu.

The feature is enabled when the function key check box  is checked.

### Function key: Effect

---

**Time format**: Press to select the format for the time display (12 or 24-hour).



**OR**: Select the format for the time display

---

**Date format**: Press to set the sequence for the date display.



**OR**: Set the sequence for the date display

---

**Set time**: Set the time by pressing the arrow buttons  or  and confirm change with **OK**.

**OR**: Set the time

---

**Set date**: Set the date by pressing the arrow buttons  or  and confirm change with **OK**.

## Function key: Effect

---

---

**OR:** Set the date

---

**Units:** Set units for displays in the vehicle.

**OR:** Set units for displays in the vehicle

---

**Service/inspection:** Settings for the Service reminder display and the service position of the windshield wipers. Display of current oil level  
⇒ page 587 and service messages.

**OR:** Service menu.

---

**Lights and vision:** Settings for lighting outside the vehicle and inside the passenger compartment

---

**Instrument cluster:** Settings for the instrument cluster

---

**Seat settings:** Settings for the front seats

---

**Vehicle key:** Settings for convenience closing

---

**Central locking:** Settings for the central locking system

---

**Garage door opener:** Settings for the garage door opener

---

**Vehicle ID/Number of keys:** Display of vehicle chassis number and number of authorized remote control vehicle keys

---

**Tire pressure monitoring:** Settings for the Tire Pressure Monitoring System (TPMS)

Changes made in settings menus are automatically applied once the menu is closed.

## Service menu

---

**ⓘ Please first read and note the introductory information and heed the WARNINGS ⚠**

- Switch on the ignition.

- Press the **CAR** Infotainment button.
- Tap the **Service** function key on the screen.
- **OR:** Tap the **Settings** and then tap the **Service/inspection** function key on the screen.

Display of current oil level and service messages

Pressing the **←** function key always takes you back to the previously active menu.

The feature is enabled when the function key check box  is checked.

### **Function key: Effect**

---

**Reset Interval service:** Reset Service reminder display

---

**Wipers in service pos.:** Activate or deactivate the service position of the windshield wipers



# Radio mode

## Introduction

---

In this section you'll find information about:

Opening the RADIO main menu and changing frequency band  
Changing radio station or selecting a station from the station list  
Scan feature (Scan)  
Manually selecting a station frequency  
HD radio   
Changing the station buttons and storing a radio station  
Selecting stations stored to station buttons  
Satellite radio mode  
Satellite radio main menu  
Changing station and selecting a category  
Radio settings

### More information:

- Safety information  for Infotainment System
- Basic information on use

### WARNING

**Driving on today's roads demands the full attention of the driver at all times. Driver distraction causes accidents, collisions and serious personal injury!**

- **Never let yourself be distracted when setting, adjusting, or using the Infotainment System, when using your mobile phone, or when operating the mobile phone controls.**
- **Always drive attentively and responsibly. Use the Infotainment system, your mobile phone, and the mobile phone controls only if road, traffic, and weather conditions permit and you will not be distracted from your driving.**
- **If you cannot use the Infotainment System, your mobile phone, or the mobile phone controls safely while driving, wait until later or find a safe spot where you can pull off the road and park the vehicle.**
- **Always set sound volume levels so that you can clearly hear horns, sirens, and other warning sounds outside the vehicle.**

 Parking garages, tunnels, high buildings or mountains can interfere with the radio signal.

 Decals or metal-coated stickers on the vehicle windows can affect radio reception in vehicles with window antennas.

## Opening the RADIO main menu and changing frequency band



Fig. 142 RADIO main menu in FM mode.

⚠ Please first read and heed the WARNINGS ⚠ note the introductory information and heed the WARNINGS ⚠

### Opening the RADIO main menu

- Press the **BAND** Infotainment button to open the *RADIO* main menu with the frequency band that was last set ⇒ fig. 142.

The set frequency band is displayed in the top left corner of the screen.

The station you are currently listening to is shown in the middle of the screen.

### Station name display (RDS)

If RDS is available, the station name can be displayed provided the reception is sufficiently strong ⇒ fig. 142.

RDS (Radio Data System) is a radio data service that is not supported by all units and is not available everywhere or from every radio station.

### Changing the frequency band

- In the *RADIO* main menu, press the **Band** function key.
- Call up the desired frequency range by pressing a function key in the pop-up window.

### Function keys in the radio main menu

#### Function key: Effect

---

**Band**: For selecting the desired frequency band.

---

**Stationlist**: For accessing the list of currently receivable radio stations

---

**Presets**: To select the station buttons displayed in the *RADIO* main menu

---

**Extras**: Opens a pop-up window with further options.

## Function key: Effect

**Scan**: Starts and stops the scan feature

**Screen off**: Switching off the display. To switch on again, press any Infotainment button or touch screen.

**Tune**: Opens the frequency dial for the selected frequency band

**1...** to **36...**: Station buttons for storing radio stations

## Changing radio station or selecting a station from the station list



Fig. 143 FM-station list: Station 2 is playing.

⚠ Please first read and heed the WARNINGS ⚠ note the introductory information and heed the WARNINGS ⚠

### Switching through radio stations

- Briefly press an arrow button ◀ or ▶ on the screen ⇒ fig. 142.

### Selecting stations from the station list

The unit regularly searches for stations with a strong reception and stores them in the station list.

- Press the ▶ **Stationlist** function key to open the station list for the selected frequency range.

The station list “jumps” straight to the view of the station you are listening to ⇒ fig. 143.

- Call up stations from the station list by touching them or selecting them with the setting knob ⇒ fig. 131 (3) (Browsing lists).
- To close the station list, press the ◀ function key.

The station list closes automatically after approximately one minute of inactivity.

## Scan feature (Scan)

---

ⓘ Please first read and heed the WARNINGS ⚠ note the introductory information and heed the WARNINGS ⚠

When the scan feature is running, all available stations on the current frequency band are played in sequence for roughly 10 seconds each.

- Open the *RADIO* main menu and select the frequency band
- Touch the **Extras** function key.
- In the pop-up window, press the **Scan** function key.

Station scanning starts and the **Extras** function key switches to **▶Scan**.

- Press the **▶Scan** function key to stop the scan feature at the station that is currently playing.

The scan feature also stops when you manually select a station with the arrow buttons

## Manually selecting a station frequency

---



Fig. 144 RADIO main menu with the frequency dial for the selected frequency band.

ⓘ Please first read and heed the WARNINGS ⚠ note the introductory information and heed the WARNINGS ⚠

### Displaying and hiding the frequency dial

- Open the *RADIO* main menu and select the frequency band
- Press the **Tune** function key to display the frequency dial of the selected frequency band

⇒ fig. 144.

- **OR:** Turn the setting knob ⇒ fig. 131 (3) *one stop further*.
- To hide the frequency dial, briefly *press* the setting knob.



The frequency dial is hidden automatically after approximately 5 seconds of inactivity.

Manual frequency selection is also closed if you select a station with a station button.

### Adjusting the frequency in stages

- Briefly *press* one of the arrow buttons to the right and left of the frequency dial.
- **OR:** Turn the setting knob ⇒ fig. 131 (3).

### Quickly browsing the frequency band

- Place your finger on the slider  in the frequency dial and drag it along the dial .
- **OR:** Press a point on the scale either side of the slider. The slider will then  “jump” straight to the selected point.
- **OR:** Press one of the arrow buttons at the top of the screen. The slider automatically runs through the frequency band in the corresponding direction and stops when a station has been found.

Applicable only in the United States

### HD radio



Fig. 145 Digital main station set.

 Please first read and heed the **WARNINGS**  note the introductory information and heed the **WARNINGS** 

Some radio stations also provide their output in digital format as “HD Radio™”.

HD Radio™ must be activated in the **Radio settings**

If the station you are listening to broadcasts in HD Radio™, the radio automatically switches to digital HD radio reception.



The “” symbol is displayed as active at the top right of the screen when digital reception is active.

When you leave the area with digital coverage, the radio switches to the analog main station and “” symbol is shown as inactive (gray).

### Setting HD radio sub-channels

Some HD radio stations provide additional sub-channels via their digital channel.

Available sub-channels are shown on the screen while the main channel is selected (display: **HD1**, **HD2** etc.).

- Press the arrow button  on the screen to set the next sub-channel.
- Press the arrow button  again to change to the next sub-channel. If there is no other sub-channel available then the next change takes you to the next available station.
- Pressing the arrow button  to change back up through the available sub-channels to the main channel.

The sub-channel that is currently selected is shown on the screen after the display of the main channel (such as . . . -**HD2** for the second sub-channel).

The station list only shows the sub-channels of the set main channel. The sub-channels of other HD radio stations cannot be displayed.

## Changing the station buttons and storing a radio station



Fig. 146 RADIO main menu.

⚠ Please first read and heed the WARNINGS ⚠ note the introductory information and heed the WARNINGS ⚠

In the *RADIO* main menu, you can store stations from **all** frequency bands on 36 numbered function keys. These function keys are called “station preset buttons”.

If **no station buttons are displayed** in satellite radio mode, the song info feature has been activated

### Changing the displayed station buttons

The station buttons are displayed in groups of six function keys.

- In the *RADIO* main menu, press the **Presets** function key.
- In the pop-up window, press to select the desired group of station buttons (for example [fig. 146: memory 1...6](#)).

### Storing stations on a displayed station button

Storing a station to a station button overwrites any station previously stored to that button.

If the station you are listening to is stored to a station button, the name of the frequency band displayed in the *RADIO* main menu is followed by the station button number ⇒ [fig. 147](#).

- Select a frequency band and station.
- Press the desired station preset button until a signal tone sounds.
- The station currently playing is now stored on that station button.

All stored stations can be deleted together

## Selecting stations stored to station buttons



Fig. 147 RADIO main menu: Preset 4 selected.

ⓘ Please first read and heed the WARNINGS ⚠ note the introductory information and heed the WARNINGS ⚠

- Selecting station buttons to be displayed in the *RADIO* menu
- Press the station button in which the desired station is displayed.
- **OR:** If an arrow is displayed on the **Presets** function key, you can also browse through the stored stations with the arrow buttons (**Radio settings**).

It is possible to switch to a stored station on a different frequency band.

A stored station can only then be played if it can still be received at the current location.

## Satellite radio mode

ⓘ Please first read and heed the WARNINGS ⚠ note the introductory information and heed the WARNINGS ⚠

In the USA and Canada satellite radio with a large selection of audio programs of varied categories (music, news, sport, entertainment etc.) can also be received.

Satellite radio services are subject to subscription charges. The subscription must be activated for use either by telephone or Internet using the unit-specific Sirius ID.

### Displaying the Sirius ID

- Press the **SETUP** Infotainment button ⇒ fig. 131.
- Press the **Radio** function key.
- Press the function key **SIRIUS ID**.

The Sirius ID and the Internet address and the telephone number of the Sirius activation Hotline are displayed in the pop-up window.

Different packages can be ordered. Further information on satellite radio mode is available from Volkswagen dealerships and via the Internet address displayed.

- Press function key **OK** to close the pop-up window



The Sirius ID is also shown on channel 0.

## Satellite radio main menu

---



Fig. 148 Satellite radio main menu.

ⓘ Please first read and heed the **WARNINGS** ⚠ note the introductory information and heed the **WARNINGS** ⚠

- In the *RADIO* main menu, press function key **Band** and in the pop-up window press function key **SIRIUS** ⚡ ⇒ fig. 148.

The last used station will be selected.

The *satellite radio* main menu contains information on the selected station (station category, station name and channel number). In addition, information on the current track can also be displayed (track, artist and album name).

- Press the **SIRIUS** ⚡ function key ⇒ fig. 148.
- In the pop-up window, press the **Song Info** function key.

Track information is displayed in place of the station buttons in the lower half of the screen. If track information is not available, the window remains empty after it is opened.

- Briefly press the display window to hide the track information.
- **OR:** Press the **SIRIUS** ⚡ function key and press the **Song Info** function key in the pop-up window.

### Changing the displayed station buttons

- Press the **Presets** function key and press the desired station buttons in the pop-up window.

Storing and selecting the stored stations is described in

### Service displays on the screen

#### Display: meaning

---

**Channel Update:** The Sirius program structure is being updated. Satellite radio reception is not available while updating is in progress. After the update, some stations may be broadcast on a different channel.

**Invalid:** The station is no longer available on the stored or manually selected channel.



## Display: meaning

**Unsubscribed:** The station is not included in your current subscription package or your subscription has expired.

**Subscription Change:** In the pop-up window, press the **OK** function key to start the station update following a subscription package change.

**Linking:** Satellite radio reception is currently not available, such as under trees or in an underground parking garage.

**Antenna:** Aerial fault. Please contact a Volkswagen dealership.

## Changing station and selecting a category

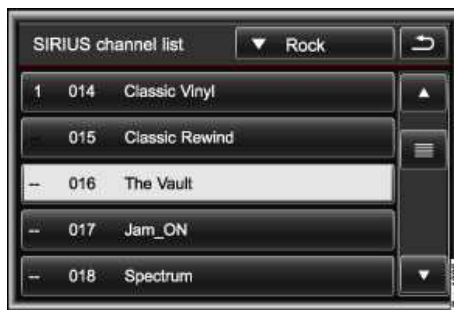

Fig. 149 Station list for station selection.

⚠ Please first read and heed the WARNINGS ⚠ note the introductory information and heed the WARNINGS ⚠

### Changing station

- Briefly press an arrow button **◀** or **▶** on the screen to select a different station.
- **OR:** Turn the setting knob ⇒ fig. 131 (3).

If an arrow **▶** is displayed on the **Presets** function key, pressing the arrow buttons changes to stored stations only. The setting can be changed in the **Radio settings** menu

### Opening the station list and selecting stations

All available stations are displayed in the station list ⇒ fig. 149.

- In the *satellite radio* main menu, press the **Channels** function key ⇒ fig. 148. The list view “jumps” straight to the view of the station you are listening to.
- Search through the list and press the required station to select it
- To close the station list, press the **↵** function key ⇒ fig. 149.

The station list closes automatically after a period of inactivity.

### Selecting a different station by changing the category

The currently selected category is displayed in the function key at the top right of the station list.

The order of the satellite stations and which categories are displayed can be preselected in the **Radio settings**

- Press the function key with the display of the current categories.
- Press a category to select it in the pop-up window.

The station list view “jumps” to the display of the selected category and plays the first station in this category.

### SCAN

- Press the **SIRIUS** function key followed by the **Scan** function key in the pop-up window to start the scan feature.

The **SIRIUS** function key changes to **Scan**. All stations of the chosen category are played in sequence for roughly 5 seconds.

- Press the **Scan** function key to stop the scan feature at the station that is currently playing.

Manually selecting a station with the arrow buttons or station buttons also stops the scan feature.

### Entering a channel number manually

The channel number for a satellite station can also be entered manually.

- In the *satellite radio* main menu, press the **Tune** function key to open an input window.
- Enter a channel number in the input window.
- Press the **OK** function key to close the input window and switch to the channel you have entered.
- To close the input window without making changes, press the **Tune** function button.

### WARNING

**Driving on today's roads demands the full attention of the driver at all times. Driver distraction causes accidents, collisions and serious personal injury!**

- **Never let yourself be distracted when setting, adjusting, or using the Infotainment System, when using your mobile phone, or when operating the mobile phone controls.**
- **Always drive attentively and responsibly. Use the Infotainment system, your mobile phone, and the mobile phone controls only if road, traffic, and weather conditions permit and you will not be distracted from your driving.**
- **If you cannot use the Infotainment System, your mobile phone, or the mobile phone controls safely while driving, wait until later or find a safe spot where you can pull off the road and park the vehicle.**
- **Always set sound volume levels so that you can clearly hear horns, sirens, and other warning sounds outside the vehicle.**

 If stations in a certain category in the station list are not displayed or cannot be called up, the category filter in the **Radio settings** may have been activated

## Radio settings

---

 Please first read and heed the **WARNINGS**  note the introductory information and heed the **WARNINGS** 

- Press the **SETUP** Infotainment button ⇒ [fig. 131](#).
- Press the **Radio** function key.

### Function key: Effect



---

**SIRIUS ID**: Displays the Sirius ID

---

**HD radio**: HD radio is activated

---

**Arrow Keys**: Define the station selection for the arrow buttons  and . Depending on the selection made, an arrow  is displayed in the function key **Stations**, **Channels** or **Presets** in all radio main menus.

 **Channel list**: All available stations and channels can be browsed in sequence with the arrow buttons.

 **Presets**: Only stations and channels that are stored to station buttons can be browsed with the arrow buttons.

---

**Category filter**: Restrict selection of stations to certain categories.

If the check box in the  **Category filter on** function key is deactivated, all categories are displayed and all stations can be selected.

---

**Sort channel list**: The station list shows all satellite stations as selected:

**Channel name**: In the all categories view arranged according to station name.

**Channel number**: In the all categories view arranged according to channel number.

**Category/chan. name**: In the category view arranged according to station name.

## Function key: Effect

---

**Category/channel no.:** In the category view arranged according to channel number.

---

**Delete preset list:** When **Delete all** is pressed, all stations and channels stored to station buttons are deleted.

## Media mode: Introduction

### Introduction

---

In this section you'll find information about:

- Data media and file requirements
- Inserting or removing data media
- Open MEDIA main menu
- Changing the media source
- Track or chapter selection in audio and video menu

"**Media sources**" are audio and video sources containing audio and video files on various different data media (such as CD, DVD, memory card, external MP3 player). These files can be played back using the corresponding players or inputs of the Infotainment System (internal CD/DVD player, memory card slot, etc.).

#### Copyright

Audio and video files stored on data media are normally subject to national and international copyright laws. Observe legal regulations!

#### More information:

- Safety information  for Infotainment System
- Basic information on use
- MEDIA-IN multimedia jack

#### WARNING

Opening a CD or DVD player's housing can lead to injuries from invisible laser radiation.

- Have CD or DVD players repaired only by a qualified workshop.

#### WARNING

Driving on today's roads demands the full attention of the driver at all times. Driver distraction causes accidents, collisions and serious personal injury!

- Never let yourself be distracted when setting, adjusting, or using the Infotainment System, when using your mobile phone, or when operating the mobile phone controls.
- Always drive attentively and responsibly. Use the Infotainment system, your mobile phone, and the mobile phone controls only if road, traffic, and weather conditions permit and you will not be distracted from your driving.
- If you cannot use the Infotainment System, your mobile phone, or the mobile phone controls safely while driving, wait until later or find a safe spot where you can pull off the road and park the vehicle.
- Always set sound volume levels so that you can clearly hear horns, sirens, and other warning sounds outside the vehicle.



## NOTICE

- When inserting and removing CDs and DVDs, always hold them at right angles to the front of the unit. Inserting or removing them at an angle to the DVD drive may lead to scratching.
- Inserting a second CD or DVD while a CD or DVD is inserted or is being ejected can destroy the DVD drive. Always wait until the data media is completely ejected.



## NOTICE

**Any foreign objects attached to a data medium and non-round data media can damage the DVD drive.**

- Only clean 12-cm standard CDs or DVDs should be used!
  - Do not attach stickers or other items to the data medium. Stickers may peel off and damage the drive.
  - Do not insert 8-cm single CDs or non-round CDs (shaped CDs) or DVDs.
  - Do not insert DVD-Plus, Dual Discs and Flip Discs, as these are thicker than standard CDs.



CDs can also be played in a DVD drive if they meet the requirements



Uneven road surfaces and strong vibrations may cause CDs and DVDs being played in the DVD drive to jump.



If the temperature inside a DVD drive is too high, loading and playback of CDs and DVDs is disabled.

## Data media and file requirements

---

**Please first read and heed the WARNINGS  note the introductory information and heed the WARNINGS **

Factory-fitted CD and DVD drives conform to safety class 1 according to DIN IEC 76 (CO) 6/ VDE 0837.

Only use 12-cm standard CDs or DVDs and memory cards with the dimensions 32 mm x 24 mm x 2.1 mm or 1.4 mm.

Data media	Conditions for playback	
	Audio files	Video files

Data media	Conditions for playback	
	Audio files	Video files
<p>Ⓒ Audio CDs (up to 80 min).</p> <p>Ⓒ Standard video DVD and DVD-compatible DVD audio.</p> <p>Ⓒ CD-ROM-, CD-R-, CD-RW audio data CD up to max. 700 MB (Megabyte) in the data system ISO 9660 Level 1 and 2, Joliet or UDF 1.02, 1.5, 2.01, 2.5.</p> <p>Ⓒ DVD+/-R/RW up to 4.7 GB and dual layer DVDs up to 8.5 GB in the Joliet file system (single-session only); UDF.</p> <p>📀 SDHC memory cards up to 32 GB. 📀 SD- and MMC memory cards in the data system FAT12, FAT16, FAT32 or VFAT up to max. 2 GB (Gigabyte) and SDHC memory cards up to max. 32 GB.</p>	<p>– Digital audio specification .</p> <p>– Bit rates from 160 kbit/s (recommended) up to 320 kbit/s and 48 kHz sampling frequency.</p> <p>– Format: MPEG layers 1, 2, and 3 (.MP3).</p> <p>– Format: Windows Media Audio 8 and 9 (.wma, .asf).</p> <p>– Format: MPEG layers 2 and 4 (.m4a, .m4b, .mp4, .aac).</p>	<p>– Bit rates up to 2000 kbit/s.</p> <p>– Maximum resolution 720 x 576 pixel.</p> <p>– Format: MPEG layers 1 and -2 (.mpg, .mpeg).</p> <p>– Format: ISO-MPEG4; DivX 3, 4 and 5 Xvid (.avi).</p> <p>– Format: ISO-MPEG4 H.264 (.mp4, .m4v, .mov).</p> <p>– Format: Windows Media Video 9 (.wmv, .asf).</p>
	<p>– Playlists supported in formats M3U, PLS and WPL (not supported by the media center (HDD)).</p> <p>– Limit of 4 partitions.</p> <p>– On DVD limit of 1000 files per medium and directory.</p> <p>– On memory cards limit of 4000 files and limit of 1000 files per directory.</p> <p>– Limit of 3000 files in the media center (HDD).</p>	

Requirements for using external data media via the MEDIA-IN multimedia jack

#### Restrictions and notes

Windows Media Audio 9 Voice, Lossless and Professional as well as DRM-protected files are **not supported**. Other data media with copy protection and multi-session CDs and DVDs can sometimes not be played back or only with limitations.

Dirt, high temperatures and mechanical damage can render a data medium unusable. Please observe data medium manufacturer information.

Quality differences between data media of different manufacturers can cause problems during playback.

The data medium configuration or the devices or programs used for recording can cause individual tracks or data medium to be unreadable. Information can be found on the Internet on the best ways to create audio files, video files and data media (compression rate, ID3 tag etc.).

Due to the larger quantity of data, it takes longer to read a data medium containing compressed audio files (such as MP3, WMA) than a "normal" audio CD. Complex directory structures can also delay the reading process. If possible, only use data media with readable audio and video files.

**Play lists** only define a certain playback sequence. Play lists do **not** save any files. Play lists **cannot** be played if the files on the data medium are **not** saved in the location to which the play list is referring (relative data path). Play lists **cannot** be copied to the media center (HDD).

## ! NOTICE

**Do not use memory card adapters.**

**i** No liability can be accepted for damaged or lost files on the data media.

## Inserting or removing data media



Fig. 150 Data media slots in glove compartment.

**⚠ Please first read and heed the WARNINGS ⚠ note the introductory information and heed the WARNINGS ⚠**

The driver should not operate the unit while driving. Insert or change data media before starting your journey.

Various data media (CDs, DVDs and memory cards) can be inserted or connected (USB storage media or MP3 players via the MEDIA-IN multimedia jack). Data media can contain both audio and video files.

Compressed and supported audio files and some video files can be saved on the **Media center** (HDD)

The slots for a CD or DVD and 2 memory cards are located in glove compartment → [fig. 150](#).

### Inserting or ejecting CDs or DVDs

- Hold the CD or DVD with the printed side facing up.
- Push the CD or DVD into the DVD slot (3) to the point where it is drawn in automatically. Do not push it in any further.
- Press the unit button **⏏** (1) to move the CD or DVD into the eject position.

Once in the eject position, the CD or DVD must be removed within about 10 seconds otherwise it will be drawn back in.



### Inserting or removing memory cards

If a memory card cannot be inserted, check the insert position and memory card.

- Insert a compatible memory card into one of the memory card slots (2) with the cutoff corner first and facing right until the card clicks into place.
- To remove, briefly press the inserted memory card. The memory card “pops” into the eject position and can be removed.

No files can be copied onto the memory card in the unit.

### Data media or files cannot be read

A message will be shown if a data medium cannot be read. The data medium needs to be removed manually.

Only supported files can be displayed and played via the Audio menu. Other files are ignored.

When you browse a media source, folders containing non-supported files are also displayed, but they appear empty once opened.

Navigation data (VCards etc.) can only be read via the **Directory** menu

### WARNING

Inserting data media when the vehicle is moving can distract you from the road and lead to accidents. Always keep the storage compartment closed when the vehicle is moving.

### NOTICE

The memory card slot's locking mechanism and the memory card can be damaged by incorrect insertion of a memory card or by inserting a incompatible memory card!

- When inserting a card, make sure it is correctly positioned.
- Excessive pressure can destroy the locking mechanism in the memory card slot.
- Only use suitable memory cards

 If you insert a number of different CDs and DVDs and receive the message **Drive error** every time, contact a qualified workshop.

## Open MEDIA main menu

---



Fig. 151 MEDIA main menu: Audio menu.



Fig. 152 MEDIA main menu: Video DVD menu.

⚠ Please first read and heed the WARNINGS ⚠ note the introductory information and heed the WARNINGS ⚠

#### Audio, video and media sources

“**Audio sources**” are sources which transmit audio signals; “**video sources**” transmit both audio and video signals. “**Media sources**” are all audio and video sources which can be selected.

In the *MEDIA* main menu different media sources can be selected and played back.

When the system is switched over to play a **standard video DVD**, the *MEDIA* main menu is opened automatically as a *Video DVD menu*

Other video sources (such as AVI films) are played back like audio files only via the *Audio menu*

#### Starting media mode

- Press the **MEDIA** Infotainment button ⇒ fig. 131.

Playback of the last media source played is continued if the data medium is still available in the Infotainment System.

Depending on the selected media source, the *MEDIA* main menu is opened as an *Audio menu* or *Video menu* ⇒ fig. 152.

If no media source is available, the *MEDIA* main menu cannot be opened.

## Changing the media source

---



Fig. 153 MEDIA main menu with display of currently playing and available media sources.

ⓘ Please first read and heed the WARNINGS ⚠ note the introductory information and heed the WARNINGS ⚠

- In the *MEDIA* main menu, press the **Source** function key ⇒ [fig. 153](#).
- Press one of the active function keys in the pop-up window to switch to playback of this media source.

The media source currently being played is highlighted. Any media source that can currently not be selected is shown as inactive ⇒ [fig. 153](#).

If a previously played media source is selected again, the playback continues at the last played position.

When **video sources are played back**, the function keys are hidden after a while.

- Briefly press the screen or **MEDIA** Infotainment button to display the function keys.

#### Optionally selectable media sources in the Audio menu

**HDD**: **Media center** (internal hard drive)

**SD**: Memory card

**INT**: Internal DVD drive

**AUX**: External audio source to AUX-IN or external data medium to multimedia jack MEDIA-IN

**BT**: Bluetooth audio transmission

#### **⚠ WARNING**

The volume may suddenly get louder when you switch media source or connect a new audio source.

- Always lower the base volume before switching media source or connecting a new audio source.

#### **! NOTICE**

Excessively loud or distorted playback can damage the vehicle speakers.

### Track or chapter selection in audio and video menu

ⓘ Please first read and heed the WARNINGS ⚠ note the introductory information and heed the WARNINGS ⚠











The tracks or chapters of the media source being played can be switched through one after the other with the arrow buttons on the screen (observe playing order of audio files and folders).

It is also possible to select tracks using the **◀** or **▶** buttons on the multi-function steering wheel.

It is **not** possible to use the arrow key to switch to playback from a play list. Playback from play list must be started manually via the menu for track selection.

#### Controlling playback via the MEDIA main menu

<b>Response</b>	<b>Effect</b>
-----------------	---------------

Response	Effect
<i>Briefly</i> press the button  once.	Switch tracks or chapters at the start of the current track or chapter.
<i>Briefly</i> press the button  twice.	Switch tracks or chapters at the start of the previous track or chapter.
<i>Briefly</i> press the button  once.	Switch to next track or chapter.
Press  and <i>hold</i> .	Fast search backward.
Press  and <i>hold</i> .	Fast search forward.
<i>Briefly</i> press the button  once.	Playback stops. The button  changes to  .
<b>OR:</b> <i>Briefly</i> press the button  once.	Playback is resumed. The button  changes to  .

## Media mode (audio):

### Introduction

---

In this section you'll find information about:

- Playing order of audio files and folders
- Playback of video files in the Audio menu
- Track display in Audio menu
- Browsing audio and media sources
- Changing playback mode
- Media center (HDD): importing files
- Media center (HDD): Accessing stored audio and video files
- External audio source connected via AUX-IN
- External audio source connected via Bluetooth®
- AUX volume: adjusting playback volume

#### More information:

- Safety information  for Infotainment System
- Basic information on use
- Media mode: Introduction
- MEDIA-IN multimedia jack

### Playing order of audio files and folders

---

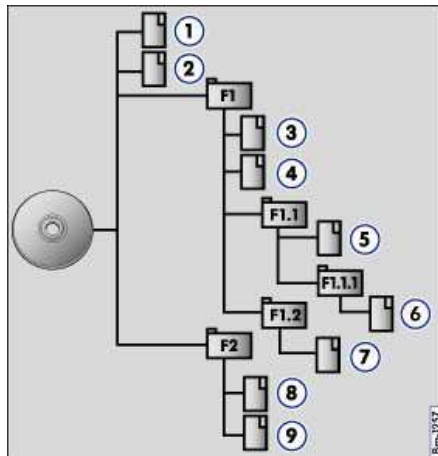







Fig. 154 Possible structure of an audio data CD or DVD.

 Please first read and heed the WARNINGS  and note the introductory information

Files  on data media are often organized by means of folders  and play lists  to determine a certain playing order.

Files, folders and playlists on a data medium are sorted by name in alphanumerical order.

The illustration shows a typical audio data CD that contains tracks , folders  and sub folders  ⇒ [fig. 154](#).

The tracks are played back as follows:

1. Tracks (1) and (2) in the CD's root directory
2. Track (3) and (4) in the **first** directory **F1** in the root directory of the CD
3. Track (5) in the **first** subdirectory **F1.1** of the directory **F1**
4. Track (6) in the **first** subdirectory **F1.1.1** of the subdirectory **F1.1**
5. Track (7) in the **second** subdirectory **F1.2** of the directory **F1**
6. Track (8) and (9) in the **second** directory **F2**

Play lists  are treated like directories in the playback sequence.

 **WARNING**

**Driving on today's roads demands the full attention of the driver at all times. Driver distraction causes accidents, collisions and serious personal injury!**

- Never let yourself be distracted when setting, adjusting, or using the Infotainment System, when using your mobile phone, or when operating the mobile phone controls.
- Always drive attentively and responsibly. Use the Infotainment system, your mobile phone, and the mobile phone controls only if road, traffic, and weather conditions permit and you will not be distracted from your driving.
- If you cannot use the Infotainment System, your mobile phone, or the mobile phone controls safely while driving, wait until later or find a safe spot where you can pull off the road and park the vehicle.
- Always set sound volume levels so that you can clearly hear horns, sirens, and other warning sounds outside the vehicle.

 Compressed video files (Podcasts, AVI) on a data medium are treated like audio files when played back.

 Play lists are **not** automatically played, they must be specifically selected via the menu for track selection.

## Playback of video files in the Audio menu

---

 **Please first read and heed the WARNINGS  and note the introductory information**

Compressed video files (Podcasts, AVI) that are stored on a data medium can also be played back via the *Audio menu* (observe requirements for data media).

Operation and playback is same as described for the playback of audio files.

When video files are played back, the function keys are hidden after a while.

- Briefly press the screen or **MEDIA** Infotainment button to display the function keys.

 Video DVDs are played back in the *Video DVD menu*

## Track display in Audio menu



Fig. 155 MEDIA main menu: Audio menu.

### Please first read and heed the **WARNINGS** and note the introductory information

Track information on various artists and albums are stored in the unit (Gracenote™-database). Furthermore track information may be stored on the data medium itself (CD text, ID3 tag for MP3 files).

Meta data containing the album, track, artist, genre and comments for MP3, WMA and M4A files can be exported as track information. The **track name** is displayed in the center with the **artist** above it and the **album name** below it ⇒ [fig. 155](#).

If the corresponding information is stored on the data medium, a picture of the album cover can also be displayed at the top right instead of the placeholder (maximum resolution: 800 x 800 pixels, file format: GIF, JPEG or PNG).

You will find information on how to create audio files so that track and cover information can be read by the unit on the Internet, for example. Observe requirements for data media and files.

If no track information is available for the track being played or display of track information is disabled, only the **Track** and the track number according to the order on the data medium will be displayed.

The elapsed playing time and the remaining playing time are displayed in minutes and seconds to the left and right of a progress bar. The running time display might be incorrect for files with a variable bit rate.

### Deactivating track information display

- Press the **SETUP** Infotainment button ⇒ [fig. 131](#).
- Press the **Media** function key.
- Check the check box in the **Activate artist/track name** function key by pressing it .



Fig. 156 Track list of a playing audio CD.



Fig. 157 Track list of a playing audio data CD.

⚠ Please first read and heed the WARNINGS ⚠ and note the introductory information

In the *Audio menu* ⇒ [fig. 155](#), tracks are changed using the function keys on the screen.

### Selecting tracks from the track list

- Select media source for playing back audio files.
- In the *Audio menu*, press the **Select** function key to open the track list.
- Browse through the track list.
- Press the desired track to select it.

Tracks can also be opened from the track list by turning the setting knob ⇒ [fig. 131 \(3\)](#) to select them and then pressing it.

The track that is currently playing is highlighted in the track list ⇒ [fig. 156](#).

If track information is available, the track name is displayed in the selection menu instead of **Track**.

The media source is displayed in the title bar.

### Browsing data media

You can manually search through the folder structure of a data medium where the files are organized by means of folders and playlists.

- Touch the display of a playlist 📄 or of a folder 📁 in the track list (such as **F1.1.1**) to open it ⇒ [fig. 157](#).



- Press the  function key to open the current folder's parent folder (for example : **F1**).

The audio source and the folder currently opened are displayed in the title bar (in ⇒ [fig. 157: SD card](#) and folder **F1.1**).

Pressing the  function key several times switches from one folder to another until you reach the top selection level of the data media.

If only the name of a data medium is displayed in the title bar, this means the root directory of the data media is opened ⇒ [fig. 160](#).

## Changing playback mode





[Fig. 158](#) Extras pop-up window for audio mode.

 Please first read and heed the **WARNINGS**  and note the introductory information

Refer to the information on the playing order of audio files and folders.

Only one playback mode can be active at any one time. Each selected playback mode is indicated in the respective function key (such as .

### Starting random play or (Mix) scan (Scan)

- During playback, press the  function key in the *Audio menu* ⇒ [fig. 158](#).
- Press  or  in the pop-up window to start the mix or scan feature and close the pop-up window.

### Starting the repeat feature (Repeat)

- During playback in the *MEDIA* main menu, press the  function key and select the repeat feature by pressing.

The range of repeat functions available depends on the selected audio source and the type of audio files played.

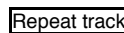
 repeats the current track.

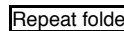
 repeats all tracks of the current folder.

### Stopping playback mode

The random play (Mix) and repeat functions (Repeat) remain active for the corresponding audio source until they are closed for that source.

- Press the function key with the display of the current playback mode (such as  to resume normal playback at the current track.

The scan feature (Scan) and random play (Mix) are stopped if a track is selected manually.

## Media center (HDD): importing files

---



Fig. 159 Select audio files to be imported.

**⚠ Please first read and heed the WARNINGS ⚠ and note the introductory information**

The “Media center” is on the hard disk drive inside the unit (HDD<sup>6</sup>).

Compressed audio files (MP3, WMA) and some video files (podcasts, AVIs etc.) can be imported from various data media into the **Media center** and played from there.

Only perform the copying procedure while the engine is running. CDs and DVDs with copy protection may not be copied.

### Selecting a memory location and copying tracks

- Switch to the media source from which you want to import files to the **Media center**
- In the *Audio menu*, press the **Extras** function key ⇒ [fig. 158](#).
- Press the **Import** function key to import the file.

The data medium is prepared. This procedure can take a few seconds.

- The **Import** menu is then opened ⇒ [fig. 159](#).
- Check the check boxes next to the files or folders that you want to import.
- If you activate **Select all**, all files and folders on the data medium will be imported.
- Press the **Import** function key.

The selected files and folders are imported into the **Media center** using the displayed names.

If no track information is available, audio files are imported as “**Track**” and albums or artists as “**Unknown**” with serial number.

### Functions and progress display during the copying operation

A progress indicator is displayed during the copying procedure.

- Press the **Cancel copying** function key to end the import with the last complete stored track.
- Press the **MEDIA** Infotainment button to close the progress indicator.
- Press the **Source** function key and press another media source to call it up ⇒ [fig. 153](#).

The copying progress indicator can be displayed again.

---

<sup>6</sup> HDD stands for Hard Disc Drive (hard drive).

- In the **Audio menu**, press the **Extras** function key ⇒ [fig. 158](#).
- In the pop-up window, press the **Import** function key.

#### Checking hard disk capacity of Media center

- In the **Audio menu**, press the **Extras** function key ⇒ [fig. 158](#).
- In the pop-up window, press the **HDD capacity** function key.

The **HDD capacity** menu shows how much hard drive memory space is used and how much is still available for storage.

- Press the **Exit** function key to close the menu.

**i** If the unit cancels a copying operation, check the capacity of the internal hard drive and check the source data medium.

**i** Play lists **cannot** be imported into the media center (HDD).

### Media center (HDD): Accessing stored audio and video files



[Fig. 160](#) Selection menu for media center.

**⚠ Please first read and heed the WARNINGS ⚠ and note the introductory information**

When tracks are stored, they are sorted into different categories and lists according to the available track information (**Playlists**, **Artists**, **Albums**, **Track**, **Genres** and **Videos**).

The stored tracks can be displayed in these lists using different sort methods and also opened from there.

- Switching to **Media center** (HDD)
- In the **Audio menu**, press the **Selection** function key to open the track list for the track being played.
- Press the **Media center** function key until the selection menu for the **Media center** opens ⇒ [fig. 160](#).
- Press one of the function keys to open the corresponding list view.
- Browse the media center and select tracks as described for audio and media sources

#### Deleting stored audio files (tracks) and folders

- Switching to **Media center** (HDD)
- Touch the **Extras** function key.

- In the pop-up window, press the **Delete** function key.
- Next search through the **media center** for files that you want to delete.
- List entries (tracks and folders) can be selected individually by pressing .
- If you press the **Select all** function key, all list entries will be selected .
- Press the **Delete** function key to delete all selected entries.
- Accept the confirmation dialog by pressing the **Delete** function key.

The delete process may take some time, depending on the number of files being deleted.

 For copyright reasons, **all** files stored in the media library need to be deleted before the unit is passed on.

 Using the voice control, you can also record the name of an artist, album or track stored in the media center after the corresponding voice command

## External audio source connected via AUX-IN

 **Please first read and heed the WARNINGS  and note the introductory information**

In some vehicles, there is an AUX-IN socket in the storage compartment in the front center armrest. Connect the external audio source to the AUX-IN socket using a suitable cable with 3.5-mm jack plug.

If instead your vehicle has a MEDIA-IN multimedia jack in the front center armrest stowage compartment, an adapter cable should be used to connect the external audio source with a 3.5-mm jack plug.

Before connecting or playing an external audio source, turn down the base volume on the Infotainment System. The **output volume** of an external audio source can be adjusted to the volume of the other audio sources later on.

Audio sources connected via AUX **cannot** be controlled via the Infotainment System. Playback is started, controlled and stopped via the external audio source.

You need to switch over the system in the *Audio menu* to playback the external audio source over the vehicle loudspeakers

**AUX/Bluetooth audio** is displayed on the Infotainment System screen.

Otherwise only the **Source** function key is displayed to switch media sources

 **WARNING**

**External devices that are loose or not securely attached can be thrown around the passenger compartment during a sudden driving or braking maneuver or in a crash.**

- **While the vehicle is in motion, always secure external devices properly outside the airbag deployment zones or stow them away safely.**
- **Always route wires for external devices so that they do not interfere the driver's view through the windows.**

 If the external audio source is powered by the 12 Volt socket of the vehicle, interference is possible.

## External audio source connected via Bluetooth®

---

 Please first read and heed the **WARNINGS**  and note the introductory information

Bluetooth audio mode is only available if the vehicle is equipped with a factory-fitted mobile phone package. The external Bluetooth audio source must support the A2DP Bluetooth profile.

The Bluetooth audio source needs to be connected to the Infotainment System via the telephone control

The  **Bluetooth audio (A2DP)** feature needs to be activated in the Bluetooth settings via the **Telephone settings** menu

### Starting playback via the vehicle speakers

Before connecting or playing an external audio source, turn down the base volume on the Infotainment System.

Playback is started and stopped via the Bluetooth audio source.

You need to switch over the system in the *Audio menu* to playback the Bluetooth audio source over the vehicle loudspeakers

**AUX/Bluetooth audio** is displayed on the Infotainment System screen.

### Playback control

The extent to which the Bluetooth audio source can be controlled using the infotainment system depends on the Bluetooth audio source connected up.

With media players which support the AVRCP Bluetooth profile, replay can be automatically stopped or started at the Bluetooth audio source, when switching to Bluetooth audio or another audio source. A track can also be displayed or changed via the infotainment system.

As a general rule, it is not possible to display a list of track or select various playback modes using Bluetooth audio sources.

 Due to the large number of different Bluetooth media players available, it is not possible to guarantee operation of all functions described here.

 On a connected Bluetooth audio source, all warning and service tones, such as touch tones on a mobile phone, should be switched off to avoid interference and malfunctions.

 Always switch off the warning and service tones on a connected Bluetooth audio source, e.g. key tones on a mobile telephone, to prevent interference noise and malfunctions.

 Do not connect an external media player to the infotainment system for playback via Bluetooth and via the MEDIA-IN multimedia interface **at the same time** as this may lead to problems in playback.

## AUX volume: adjusting playback volume

---

 Please first read and heed the **WARNINGS**  and note the introductory information

You can adjust the **input volume** on the Infotainment System for some external audio sources (such as for external audio sources connected via AUX). The **output volume** of an external audio source can be adjusted to the volume of the other audio sources.

If you need to increase the output volume, first lower the base volume on the Infotainment System

### Open settings menu

- Connect the external audio source.
- Press the **SETUP** Infotainment button ⇒ [fig. 131](#).
- Press the **Media** function key.
- Press the **AUX volume** function key.
- Move the slider  to change the setting

### Adjusting the output volume

If the sound from the external audio source is **too quiet**, if possible, increase the **output volume** on the audio source. If that is not sufficient, increase the **AUX volume**.

If the sound from the connected audio source is **too loud or distorted**, if possible, lower the **output volume** on the audio source. If that is not sufficient, decrease the **AUX volume**.



The **AUX volume** function key is only displayed if the playback volume for the connected audio source can be adjusted.

# MEDIA-IN multimedia jack

## Introduction

---

In this section you'll find information about:

- Requirements and information
- Connecting and operating

Audio files and some video files on an external data medium connected to the MEDIA-IN multimedia jack can be played and controlled via the Infotainment System.

Where this manual refers to external data media, this means USB mass storage devices containing supported files, such as MP3 players, iPods® and USB sticks. External data media and audio sources are displayed as **AUX** on the Infotainment System.

The MEDIA-IN multimedia jack provides 5 Volts, commonly used by USB devices.

### More information:

- Safety information  for Infotainment System
- Basic information on use
- Media mode

### WARNING

External devices that are loose or not securely attached can be thrown around the passenger compartment during a sudden driving or braking maneuver or in a crash.

- While the vehicle is in motion, always secure external devices properly outside the airbag deployment zones or stow them away safely.
- Always route wires for external devices so that they do not interfere the driver's view through the windows.

### WARNING

The volume may suddenly get louder when you switch media source or connect a new audio source.

- Always lower the volume before switching media source or connecting a new audio source.

## WARNING

Driving on today's roads demands the full attention of the driver at all times. Driver distraction causes accidents, collisions and serious personal injury!

- Never let yourself be distracted when setting, adjusting, or using the Infotainment System, when using your mobile phone, or when operating the mobile phone controls.
- Always drive attentively and responsibly. Use the Infotainment system, your mobile phone, and the mobile phone controls only if road, traffic, and weather conditions permit and you will not be distracted from your driving.
- If you cannot use the Infotainment System, your mobile phone, or the mobile phone controls safely while driving, wait until later or find a safe spot where you can pull off the road and park the vehicle.
- Always set sound volume levels so that you can clearly hear horns, sirens, and other warning sounds outside the vehicle.

## Requirements and information

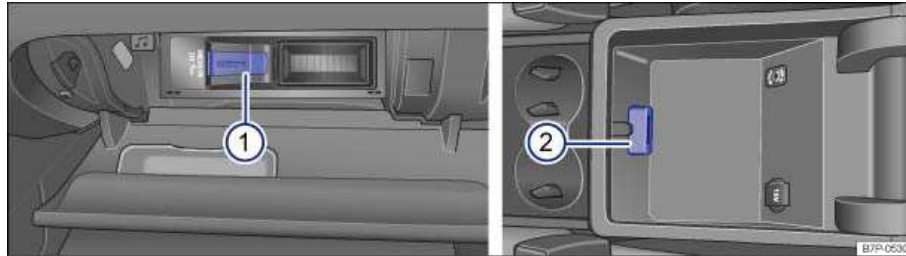

Fig. 161 MEDIA-IN multimedia jack.

### Please first read and note the introductory information and heed the WARNINGS

The MEDIA-IN multimedia jack may be located in the glove compartment, or in the front center armrest storage compartment ⇒ fig. 161 (1) or (2).

### Adapter for connecting a data medium

An external data medium must be connected to the MEDIA-IN multimedia jack using an adapter.

An adapter is included with the vehicle. Additional adapters can be obtained from the Volkswagen dealer.

Do not use memory card adapters, USB extension cables or USB hubs!

### Requirements

Only files that can be read via the MEDIA-IN multimedia jack can be displayed, played and controlled on the Infotainment System.

MTP players are not supported.

Read and follow the operational instructions of the external data medium.

Please observe further requirements, restrictions and notes



## Connectable data media

- USB flash drives (USB sticks).
- USB data media that do not need special drivers.
- External USB flash drives.
- External USB hard drives (HDD)
  - 1", 1,8", 2,5" with maximum peak and continuous current 500 mA.
- iPods<sup>®</sup> and iPhones<sup>®</sup> of various generations<sup>7</sup>.

## Requirements for playback via the Infotainment System

- USB 2.0 enabled media.
- Subclass 1 and 6 USB devices (note manufacturer's information).
- Data media in the FAT or FAT32 file systems.
- Limit of 4 partitions and 4000 files on the data medium.
- Limit of 1000 files per directory.

## Connecting and operating



Fig. 162 Selection menu of available media sources.

**⚠ Please first read and note the introductory information and heed the WARNINGS ⚠**

Before connecting or playing an external data medium, turn down the volume on the Infotainment System

### Connecting or disconnecting an external data medium

- Connect an appropriate adapter to the MEDIA-IN multimedia jack
- Connect the external data medium to the MEDIA-IN multimedia jack via the adapter.
- If applicable, switch on the external data medium and select the appropriate data mode.

Even though the display may indicate otherwise, the external data medium may be disconnected from the MEDIA-IN multimedia jack at any time without data loss.

### Operation via the Infotainment System

An external data medium that is correctly connected to the MEDIA-IN multimedia jack can be operated via the Infotainment System.

<sup>7</sup> iPod<sup>®</sup> and iPhone<sup>®</sup> are protected trademarks of Apple Inc.

- In the **Audio menu**, press the **Source** function key ⇒ [fig. 162](#).
- In the pop-up window, press the **AUX** feature key.

Further operation of the external data medium (changing track, selecting tracks and playback modes) is described in the appropriate chapters of this manual ⇒ page 277.

### iPod® and iPhone®

When an iPod® or iPhone® is connected, a special iPod selection menu is displayed at the top selection level similar to the **Media center** selection menu ⇒ page 277. There you can select list views specific to the iPod (**Playlists**, **Artists**, **Albums**, **Songs**, **Podcasts** etc.).

The iPod selection menu is used as normal.

The music control of a connected iPod® or iPhone® is disabled.

The **output volume** of some iPods® or iPhones® can be adjusted to the volume of the other audio sources

Files **cannot** be imported from an iPod® or iPhone®. The setting for the **Repeat** feature **cannot** be changed.

### Possible error messages after connecting an external data medium

Error message	Cause	Remedy
<b>Device is not supported.</b>	Playback of the external data medium or communication via the adapter cable is not possible.	Check the adapter cable. Update software of the MEDIA-IN multimedia jack via the Volkswagen dealer. If possible, update the software of the external data medium.
<b>Device not functional</b>	Communication malfunctioning.	Verify the connection and functionality of external data medium.

Due to the large number of different types of data media and several iPod® and iPhone® generations, no guarantee can be made that all functions described can be executed without errors.

## Media mode (video DVDs)

### Introduction

---

In this section you'll find information about:

Starting video DVD mode and operating the DVD film menu

Video DVD menu: controlling playback and changing display settings

DVD settings

#### **Regional code of video DVDs**

The compatibility of video DVDs is often restricted to certain regions (e.g. USA and Canada) by "regional codes". These video DVDs can only be played in units that are coded for the same region.

The unit's DVD drive is configured to read the regional code for the region in which the vehicle was originally sold.

#### **More information:**

- Safety information  for Infotainment System
- Basic information on use
- Media mode

 **WARNING**

**Driving on today's roads demands the full attention of the driver at all times. Driver distraction causes accidents, collisions and serious personal injury!**

- **Never let yourself be distracted when setting, adjusting, or using the Infotainment System, when using your mobile phone, or when operating the mobile phone controls.**
- **Always drive attentively and responsibly. Use the Infotainment system, your mobile phone, and the mobile phone controls only if road, traffic, and weather conditions permit and you will not be distracted from your driving.**
- **If you cannot use the Infotainment System, your mobile phone, or the mobile phone controls safely while driving, wait until later or find a safe spot where you can pull off the road and park the vehicle.**
- **Always set sound volume levels so that you can clearly hear horns, sirens, and other warning sounds outside the vehicle.**

 You may not be able to play video DVDs which you have burned yourself.

 The video image is shown on the Infotainment System screen only when the vehicle is stationary. The screen is switched off while the vehicle is in motion, but the sound can still be heard.

## Starting video DVD mode and operating the DVD film menu



Fig. 163 Video DVD menu.

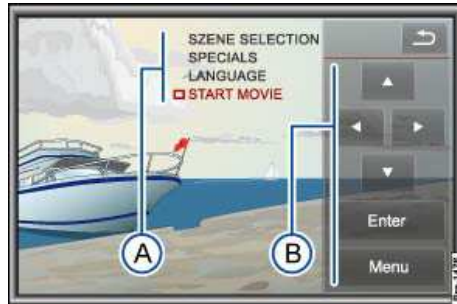

Fig. 164 DVD menu options of the inserted film.

⚠ Please first read and heed the WARNINGS ⚠ note the introductory information and heed the WARNINGS ⚠

- Insert a video DVD compatible with the unit into the DVD drive and start playback from this media source

It can take a few seconds to read out the data from a video DVD, during which time the screen remains dark.

The "Intro" stored on the video DVD (a short introductory sequence) is played. The film menu is then displayed (DVD film menu ⇒ fig. 164 (A)).

### Operating the DVD film menu with the unit's own menu control

The DVD film menu (A) cannot be controlled directly by touching the screen, instead it can only be operated using the function keys of the unit's own menu control (B).

- Briefly press the screen to show the *video DVD menu* ⇒ fig. 163.
- Press the **Menu** function key to display the unit's own menu control (B).
- Press the arrow buttons to select the options in the DVD film menu (A) one after another.
- Press the **Enter** function key to access a selected menu option.
- Briefly press the screen to hide the unit's own menu control (B).

### Opening the DVD film menu manually

The DVD film menu must be opened manually if the DVD film menu does not open automatically with the unit's own menu control, or if the video DVD is already being played.

- In the *video DVD menu*, press the **Menu** function key to open the unit's own menu control ⇒ [fig. 163](#).
- If an introduction is playing, it can be skipped by pressing the **Menu** function key in the unit's own menu control ⇒ [fig. 164 \(B\)](#).

The DVD film menu is displayed [\(A\)](#).

### DVD does not start!

Note that an inserted DVD cannot start automatically if the volume is set to "0" (display: ). A played media source is always stopped (paused) in this case.

 The visual appearance of the DVD film menus and the menu options which it offers are the responsibility of the DVD manufacturer.

 The language of a video DVD for voice output can be changed

 The DVD manufacturer is responsible for the different ways in which individual films respond to identical commands.

## Video DVD menu: controlling playback and changing display settings

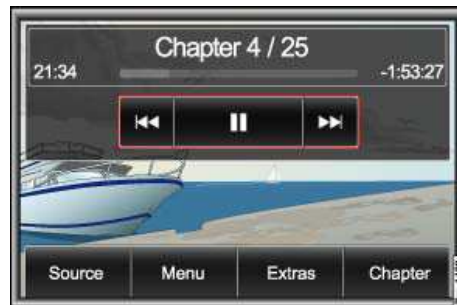

[Fig. 165 Video DVD menu.](#)

 Please first read and heed the **WARNINGS**  note the introductory information and heed the **WARNINGS** 

The *video DVD menu* is controlled in the same way as the *MEDIA* main menu.

- Change the media source
- Control film playback using the arrow buttons

### Displaying and hiding video DVD menu

- Briefly press the screen to display or hide the *video DVD menu* ⇒ [fig. 163](#).

## Chapter selection

- In the *Video DVD menu*, press the **Chapter** function key ⇒ [fig. 165](#).
- Press the desired chapter to select it from the list.

Film playback continues from the beginning of the selected chapter.

## Changing aspect ratio

The aspect ratio, in which a film is played, can be adapted to the aspect ratio of the screen.

- In the *Video DVD menu*, press the **Extras** function key.
- In the pop-up window, press the function key with the set aspect ratio to switch through the available aspect ratios one after the other.

For further information on possible aspect ratios

## DVD settings

---



**Fig. 166** Menu: Video settings.

**⚠ Please first read and heed the WARNINGS ⚠ note the introductory information and heed the WARNINGS ⚠**

- Press the **SETUP** Infotainment button ⇒ [fig. 131](#).
- Press the **Media** function key.
- In the **Media settings** menu, press the **DVD settings** function key.
- Press one of the function keys in the **DVD settings** menu to open the corresponding settings menu.

**Audio language**: Select language for audible voice output.

**Subtitles**: Define language for displayed subtitles.

**DVD format**: Set aspect ratio for picture.

The languages available for selection as the audio or subtitle language depends on the inserted video DVD.

If you select **Automatic adj.** as the aspect ratio, the aspect ratio best suited for playback will be set automatically.

# Introduction to navigation

## Introduction

---

In this section you'll find information about:

Navigation limitations

Navigation main menu

### General information

The current driving position is determined via the Global Positioning System (GPS). Sensors in the vehicle measure distances driven. All measurements are compared to the stored detailed map information and the road traffic routing stored on the navigation data medium. If required, traffic reports are taken into account in the route calculation. Based on this data, the navigation system calculates the optimal directions to the destination.

An address or a point of interest, such as a gas station or hotel, can be entered as a destination.

Acoustic navigation messages and graphic display on the navigation device and in the instrument cluster guide to the destination.

Depending on the country, some of the Infotainment System's functions can no longer be selected when the vehicle is travelling above a certain speed. This is not a malfunction, but rather compliance with legal regulations.

### More information:

- Safety information  for Infotainment System
- Basic information on use
- Destination input
- Destination memory
- Destination guidance

### WARNING

**Driving on today's roads demands the full attention of the driver at all times. Driver distraction causes accidents, collisions and serious personal injury!**

- Never let yourself be distracted when setting, adjusting, or using the Infotainment System, when using your mobile phone, or when operating the mobile phone controls.
- Always drive attentively and responsibly. Use the Infotainment system, your mobile phone, and the mobile phone controls only if road, traffic, and weather conditions permit and you will not be distracted from your driving.
- If you cannot use the Infotainment System, your mobile phone, or the mobile phone controls safely while driving, wait until later or find a safe spot where you can pull off the road and park the vehicle.
- Always set sound volume levels so that you can clearly hear horns, sirens, and other warning sounds outside the vehicle.

## Navigation limitations

---

 Please first read and heed the WARNINGS  note the introductory information and heed the WARNINGS 

## Navigation data

All navigation data required for navigation is stored in the unit navigation data memory.

Street routing is subject to ongoing changes like, for example, new streets, street names or street numbers. The route guidance may be inaccurate or incorrect if the navigation data is no longer up to date. You should therefore have the unit navigation data memory updated by a Volkswagen dealership on a regular basis. The updates are subject to a fee.

## Possible errors in navigation

When the navigation system cannot receive any data from GPS satellites (dense canopy of trees, tunnel, underground car park), navigation can still continue using the vehicle sensors.

In areas that are not or only incompletely digitized on the data medium (such as one-way streets and street type not sufficiently captured), the navigation system also tries to enable route guidance.

Please remember that the navigation may sometimes not be so accurate as usual if the precise vehicle position cannot be determined.

## Navigation main menu

---



Fig. 167 Navigation main menu: Destination mode.



Fig. 168 Navigation main menu: Tour mode.

⚠ Please first read and heed the WARNINGS ⚠ note the introductory information and heed the WARNINGS ⚠

## Accessing the Navigation main menu

- Press the **NAV** Infotainment button to open the last menu opened in the navigation function.



- Press the **NAV** Infotainment button twice in quick succession. After changing to the map display, the main menu *Navigation* is displayed.
- Press the **☰** function key to switch menu by menu from a navigation submenu to the *Navigation* main menu.
- You can switch back and forth between the map view and the *Navigation* main menu by pressing the **NAV** Infotainment button.

The *Navigation* main menu is displayed either in “normal” Destination mode or in Tour mode or as the **Waypoint navigation** menu ⇒ [fig. 208](#).

If **Tour mode** ⇒ [fig. 168](#) is displayed

If the **Waypoint navigation** menu is displayed

#### Display of the last destination

In the upper third of the screen, the destination last used as route guidance is displayed.

- Briefly touch the display box to show the displayed destination in the detailed view.
- Press the **New destination** function key followed by the **Address** function key to show the displayed destination in the **Address entry** menu and edit it

If no destination is displayed, this means no route guidance has been started or that the **destination memory** has been deleted manually

#### Function keys in the Navigation main menu

##### Function key: Effect

---

**Options**: Defines route options for calculating a route

---

**Position**: Opens the current position in the detailed view and displays the coordinates.

**Store**: Stores the displayed position in the destination memory

---

**📍**: Stores the current position as a “Flagged destination” in the destination memory

---

**🏠**: Enter home address or show home address in the *Navigation* main menu

---

**New destination**: Opens the selection menu for entry of destination

---

**Memory**: Opens a pop-up window for storing the current destination, loading stored destinations or managing destinations

---

**Route**: Opens options for route guidance

## Function key: Effect

---

**Route list**: Shows street names or street designations of the route section to be driven.

**Remove area to avoid**: Removes an entered route exclusion.

**Avoid area**: To enter a route exclusion.

---

**Extras**: Opens a pop-up window.

**New stopover**: For entering a stopover

**Tour mode**: For switching to tour mode in order to drive to several destinations during route guidance

**Waypoint mode**: For navigation in off-road areas (waypoint navigation)

---

**Start**: Starts route guidance to the displayed destination

## Destination entry

### Introduction

---

In this section you'll find information about:

Destination entry menu: defining destination selection

Address: selecting a destination address

Address entry menu

Search for points of interest using point of interest categories

Searching for points of interest using the name

Selecting special and favorite destinations from the map

Selecting destinations from the map

Entering a destination using coordinates

Selecting stored destinations (last destinations, directory)

#### More information:

- Safety information  for Infotainment System
- Basic information on use
- Introduction to navigation

#### WARNING

**Driving on today's roads demands the full attention of the driver at all times. Driver distraction causes accidents, collisions and serious personal injury!**

- Never let yourself be distracted when setting, adjusting, or using the Infotainment System, when using your mobile phone, or when operating the mobile phone controls.
- Always drive attentively and responsibly. Use the Infotainment system, your mobile phone, and the mobile phone controls only if road, traffic, and weather conditions permit and you will not be distracted from your driving.
- If you cannot use the Infotainment System, your mobile phone, or the mobile phone controls safely while driving, wait until later or find a safe spot where you can pull off the road and park the vehicle.
- Always set sound volume levels so that you can clearly hear horns, sirens, and other warning sounds outside the vehicle.

## Destination entry menu: defining destination selection

---



Fig. 169 Menu: Destination entry.

⚠ Please first read and heed the WARNINGS ⚠ note the introductory information and heed the WARNINGS ⚠

- In the *Navigation* main menu, press the **New destination** function key.

The **Destination entry** menu ⇒ [fig. 169](#) displays all possibilities for destination selection.

- Press one of the function keys to start the corresponding destination selection ⇒ [fig. 169](#).

It is possible to select new or stored destinations.

### Selecting a new destination

#### Function key: Type of destination selection

---

---

**Address**: Select destination using address information

---

**Points of interest**: Start searching for points of interest (such as hotels, petrol stations) within a particular search area. A name or a telephone number can also be entered for the search

---

**Map/GPS** Select a point on the map as destination

---

### Selecting stored destination

#### Function key: Type of destination selection

---

---

**Home address**: A home address will need to be defined before this feature is used for the first time.  
Route guidance to a previously defined home address can be started or you can edit the home address

---

## Function key: Type of destination selection

---

 **Last destinations**: Select a destination from the list of recent destinations for which route guidance was started

---

 **Favorites**: Select the destination from the list of destinations stored as favorite destinations

---

 **Directory**: Select the destination from the list of manually stored destinations

## Address: selecting a destination address

---



Fig. 170 Selecting addresses.

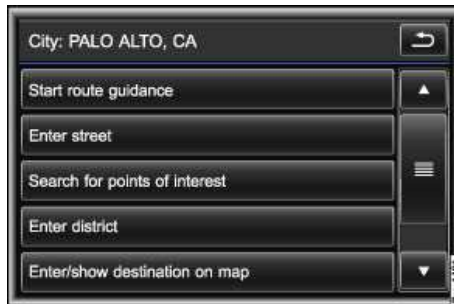



Fig. 171 Country and town selected: Narrowing down the address.

 Please first read and heed the **WARNINGS**  note the introductory information and heed the **WARNINGS** 

- In the **Destination entry** menu, press the  **Address** function key to open the **Address entry** menu ⇒ fig. 170.

For further functions in the **Address entry** menu and if a destination is already displayed

### Selecting destination parameters for the destination address

A new destination address must always be selected in the displayed sequence, first the country, then the town, etc. A "town" can be a small village or a zip code area.

The individual destination parameters (country, town, etc.) are selected using input windows

- Press the **Country** function key and select the desired country.
- Press the **City/zip** function key and select the town or zip code.

Once a town has been selected, it is already possible to start route guidance to the town center  
⇒ [fig. 171](#).

The destination address can be narrowed down further by entering a street and, following that, a house number or intersection.

- Press the **Enter/show destination on map** function key to select the destination in the map view
- When narrowing down the destination address, **please note** that every entry restricts the available range of subsequent selections. For instance, if the street you are looking for is **not** in the zip code area you have selected in a previous window, you will not be able to find the street at the street selection stage.

### Finishing destination input

- Press the **Start route guidance** function key to start route guidance to the entered destination
- **OR:** Press the **Store in directory** function key to store the destination in the destination memory

## Address entry menu

---



[Fig. 172](#) Navigation main menu with destination.



Fig. 173 Address input menu with destination address.

☐ Please first read and heed the **WARNINGS** ⚠ note the introductory information and heed the **WARNINGS** ⚠

If a destination is already displayed in the *Navigation* main menu ⇒ fig. 172, this destination will be displayed after call up in the **Address entry** menu ⇒ fig. 173.

- Press the function key next to a destination parameter to change this destination parameter in an input window or to narrow down the destination further with this parameter

Changes to one of the broad destination parameters will cause the more specific destination parameters to be deleted. If the destination parameters after **City/zip** are changed, the old parameters after **Street**, **Number** and **Intersect** are deleted.

#### Searching for address using street name

- Press the **Street** function key.

In the **Select a street** menu, the towns where you can search for a street name are listed. The town currently selected in the **Address entry** menu is displayed at the top of the list.

- Press a function key with a town name to search for a newly entered street in that town.
- **OR:** Press the **In all cities** function key to search for a street name **across the country**.

#### Further function keys in the **Address entry** menu

**Store**<sup>8</sup>: Store the displayed destination in the *destination memory* after assigning an entry name ⇒ page 312.

**Points of interest**: Select a point of interest

**Map**<sup>8</sup>: Select the destination from the map view in the vicinity of the entered address

**Start**<sup>8</sup>: Starts route guidance to the displayed destination

<sup>8</sup> This is not available unless the destination has been defined sufficiently.

## Search for points of interest using point of interest categories



Fig. 174 Selection for point of interest search.



Fig. 175 Special destination detailed view.

⚠ Please first read and heed the WARNINGS ⚠ note the introductory information and heed the WARNINGS ⚠

- In the **Destination entry** menu, press the **Points of interest** function key ⇒ fig. 169.
- The **Point of interest search** menu opens ⇒ fig. 174.

Points of interest can be searched for using point of interest categories in lists or on the map.

Points of interest can also be found using their name

### Quick search for important points of interest in your location

- Press the **Important categories** function key to open a list of frequently used point of interest categories.
- Press one of the categories to select it (in fig. 177: Hotels).

The nearest ten points of interest in the selected category are shown in a list

### Special destination search by selecting a search area and a point of interest category

In the **Search for points of interest** menu, you can set a search area for the point of interest search ⇒ fig. 174.

**In immediate vicinity:** Area around current vehicle position.



**In vicinity of destination**<sup>9</sup>: Area around last destination.

**Along the route**<sup>10</sup>: Along the calculated route.

**In a new city**: Select country and town as center of search area.

**Nationwide**: Whole of country you are currently driving in.

- Press to select search area ⇒ [fig. 174](#).
- Then press to select the desired point of interest category ⇒ [fig. 176](#).
- Some point of interest categories contain further sub-categories that are revealed upon pressing.

The points of interest found in the search area for the selected point of interest category are displayed in a list

#### **Select point of interest from list and show in detailed view**

The nearest points of interest are displayed at the top of the list of points of interest that have been found.

If the immediate vicinity has been selected as the search area, additional distance and direction details will be displayed ↗.

The distances and directions initially refer to the route as the crow flies. The arrow ↗ is shown “not filled in”.

In the background, the Infotainment System starts to calculate the route to the nearest points of interest in the list. Points of interest for which a possible route has been calculated are displayed with a “filled in” arrow. In this case, the actual distance to be driven is displayed.

The selection of points of interest can be narrowed down further by entering a name

- Touching a point of interest in the list shows the point of interest in the detailed view ⇒ [fig. 175](#).

#### **Selection options in the detailed view**

<sup>11</sup>: Opens a list where you can select other points of interest with the same address.

: Stores the points of interest in the destination memory

: Shows the point of interest on the map.

**Start**: Starts route guidance to the point of interest.

<sup>12</sup>: Makes a call to a displayed telephone number.

---

<sup>9</sup> Only if a destination has already been set.

<sup>10</sup> Can only be selected during route guidance.

<sup>11</sup> Only displayed when several points of interest with the same address can be selected.

<sup>12</sup> Only active or displayed when a telephone number is included in the point of interest information and a mobile phone or a SIM card is connected to the Infotainment System ⇒ page 360.

## Searching for points of interest using the name



Fig. 176 Select point of interest category.

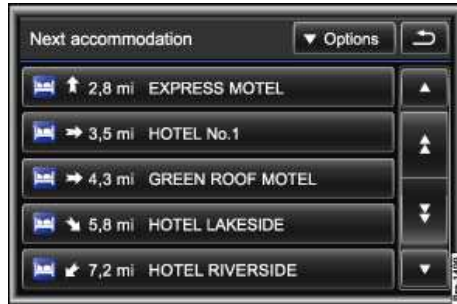

Fig. 177 List of hotels in vicinity of location.

⚠ Please first read and heed the WARNINGS ⚠ note the introductory information and heed the WARNINGS ⚠

You can also search for the name of a point of interest by entering a "keyword".

A "keyword" is a combination of digits and letters that occurs in the name or the detailed information of the desired point of interest. For example, the known part of a name can be entered, such as "Lake".

Possible results might be "Lake side Hotel" or "Green Lake Hotel" ⇒ fig. 175.

You can search for the name of a point of interest using different menus.

Response	Effect
In the <b>Search for points of interest</b> menu, press the <b>Search</b> for name function key ⇒ fig. 174.	Search for points of interest across the country and in all categories.

Response	Effect
Press the <b>Search</b> function key in a list to select a point of interest category ⇒ <a href="#">fig. 176</a> .	Search for points of interest within the previously selected search area.
In a list of found points of interest, press the <b>Options</b> function key and then the <b>Search for name</b> function key ⇒ <a href="#">fig. 177</a> .	Search for points of interest within the displayed selection of points of interest.

- Enter the keyword for the point of interest search in the subsequent input window

Correct spelling of entries is important. In the same way as when selecting a destination address, it is only possible to make entries that correspond with a point of interest stored in the navigation data.

In some lists, the **Options** ⇒ [fig. 177](#) interface can be used to put special objects into alphabetical order, according to trade names or categories.

## Selecting special and favorite destinations from the map

 Please first read and heed the **WARNINGS**  note the introductory information and heed the **WARNINGS** 

- In the **Navigation settings** menu, select point of interest symbols for display on the map
- Press the **NAV** Infotainment button until the map view is opened.

The displayed map section can be changed. To do this, touch the map with your finger and, *without lifting your finger*, drag it over the screen. Press the **GO** function key to center the map on the vehicle position again. Turn the setting knob ⇒ [fig. 131 \(3\)](#) to change the map scale.

If no symbols are displayed, turn the setting knob clockwise in order to zoom in on the map.

- Press the symbol for a point of interest category or a favorite destination on the map to open the **Point of interest** information window.

Due to the map scale, there may be several entries behind one symbol on the map, in which case a list appears for selecting the point of interest.

- Select the required entry by pressing.

### Point of interest information window

- Press the **Start** function key to start route guidance
- **OR:** Press the  function key to store the point of interest

## Selecting destinations from the map



Fig. 178 Destination on map.

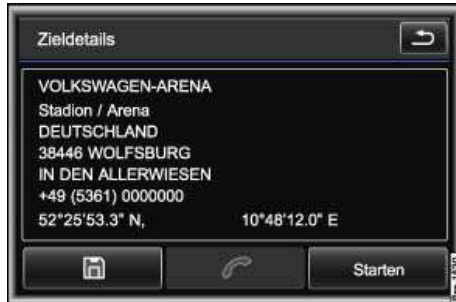





Fig. 179 Menu: Destination details.

⚠ Please first read and heed the WARNINGS ⚠ note the introductory information and heed the WARNINGS ⚠

- In the **Destination entry** menu, press the  Map/GPS function key ⇒ [fig. 169](#).
- The map display is opened ⇒ [fig. 178](#).





The most recently entered destination is shown on the map. The current location is displayed if no destination has been defined yet.

- Turn the setting knob ⇒ [fig. 131 \(3\)](#) or press the  or  function keys to change the map scale.
- In order to move the displayed map section, place your finger on the map and, *without lifting it off*, drag it over the screen.

The map view moves behind the crosshair. The destination currently selected using the crosshair is displayed in the top line of the screen. If only coordinates are displayed, this means the selected destination is in a off-road area. Such destinations cannot be reached precisely in route guidance.

- Press the  function key to start route guidance to the displayed destination.

### Other function keys

- : Briefly zooms out into an overview display.
- : Zooms into the map.
- : Zooms out of the map.
- : Centers the map view to the vehicle position or the last destination.

**OK**: Opens the destination details menu ⇒ [fig. 179](#).

### Menu: Destination details

The **Destination details** menu displays all information for the given destination.

- Press the **OK** function key to store the destination
- **☒**<sup>13</sup>: Makes a call to a displayed telephone number.
- Press the **Start** function key to start route guidance

## Entering a destination using coordinates

---

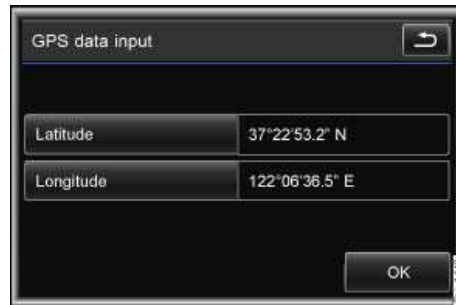

**Fig. 180** Enter the destination using coordinates.

**☒** Please first read and heed the **WARNINGS** **⚠** note the introductory information and heed the **WARNINGS** **⚠**

- Press the **GPS** function key in the map view ⇒ [fig. 178](#).

The **GPS data entry** menu is opened. The coordinates of the destination previously shown on the map are displayed ⇒ [fig. 180](#).

- Press the function key **Latitude** or **Longitude**.
- Enter the coordinates via the input window
- Press the **OK** function key when the desired latitude or longitude is displayed in the entry fields.
- In the menu **GPS data entry**, press the function key **OK** to see the destination on the map view ⇒ [fig. 178](#).

If the coordinates are outside the recorded area, you will see a corresponding message on the screen and the entry will have to be corrected.

- In the map display, press the function key **OK** to open the menu **Destination details** ⇒ [fig. 179](#).

**i** If the destination entered is not located in a digitalized area, it cannot be reached precisely in route guidance.

---

<sup>13</sup> Only active or displayed when a telephone number is included in the point of interest information and a mobile phone or a SIM card is connected to the Infotainment System 360.

 The coordinates for the current vehicle position can be shown in the *additional window* of the map display

## Selecting stored destinations (last destinations, directory)

---

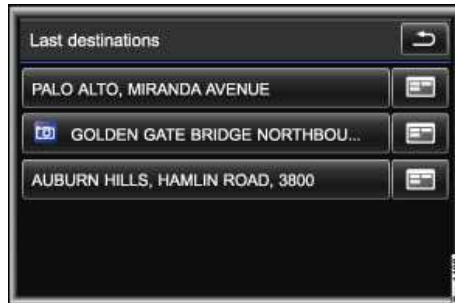

Fig. 181 List of automatically stored recent destinations.

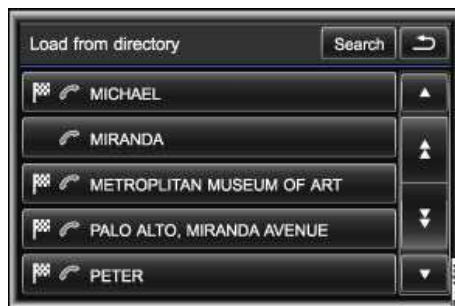

Fig. 182 Loading a destination from the directory.

 Please first read and heed the WARNINGS  note the introductory information and heed the WARNINGS 

- In the *Navigation* main menu, press the **New destination** function key ⇒ [fig. 172](#).

Route guidance to the stored home address, to an automatically stored destination or a manually stored destination can be started in the **Destination entry** menu ⇒ [fig. 169](#).

### Starting route guidance to a stored home address

- Press the **Home address** function key to start route guidance to the defined home address

### Starting route destination to an automatically stored destination or a destination stored as a favorite

Destinations originating in route guidance are **automatically** saved in the **Last destinations** list ⇒ [fig. 181](#).

**Manually** stored destinations are stored in the **Directory**. Destinations stored in the directory with the "**Display as favorite**" attribute are **also** added to the **Favorites** list

- Press the **Last destinations** or **Favorites** function key ⇒ [fig. 169](#).
- Press the entry in the list to start route guidance
- **OR:** Press the **Enter** function key next to the required entry and select one of the following options.

**Start route guidance:** Starts route guidance

**Show details:** Shows the destination in the detail view.

**Show destination on map:** Shows the destination on the map

#### **Loading a destination from the directory**

The **Load from directory** menu only displays directory entries for which route guidance can be started (display: symbol **📍**).

The directory needs to be opened for editing in order to display or edit all directory entries

- Press the **Directory** function key ⇒ [fig. 169](#).
- Press the desired directory entry in the **Load from directory** menu.
- If more than one navigation destination is stored for a directory entry, you then need to select the desired navigation destination by touching the screen.
- Press one of the following options in the **Destination details** menu.

**Start route guidance:** Starts route guidance

**Add as stopover:** Allows you to add the destination to the tour plan

**Enter/show destination on map:** Shows the destination on the map

You can also search for directory entries using a **search function**.

- Press the **Search** function key and search for the directory entry by entering the entry name in an input window

## Directory (navigation destinations, addresses and telephone numbers)

### Introduction

---

In this section you'll find information about:

Automatically stored Last destinations  
User profiles and directory entries  
Storing destinations manually  
Storing in directory  
Managing the directory  
Displays and options for directory entries  
Editing directory entries  
Favorite \*F and flagged destinations   
Importing contacts or exporting them as "VCards"  
Directory settings  
Storing or editing the home address

Destinations for which route guidance has been started are **automatically** stored in the **Last destinations** list

You can **manually** store and edit navigation destinations, addresses and telephone numbers in the unit **Directory**.

Route guidance can be started for stored navigation destinations

#### **More information:**

- Safety information  for Infotainment System
- Basic information on use
- Introduction to navigation
- Destination input
- Telephone control (PHONE)



#### **WARNING**

**Driving on today's roads demands the full attention of the driver at all times. Driver distraction causes accidents, collisions and serious personal injury!**

- **Never let yourself be distracted when setting, adjusting, or using the Infotainment System, when using your mobile phone, or when operating the mobile phone controls.**
- **Always drive attentively and responsibly. Use the Infotainment system, your mobile phone, and the mobile phone controls only if road, traffic, and weather conditions permit and you will not be distracted from your driving.**
- **If you cannot use the Infotainment System, your mobile phone, or the mobile phone controls safely while driving, wait until later or find a safe spot where you can pull off the road and park the vehicle.**
- **Always set sound volume levels so that you can clearly hear horns, sirens, and other warning sounds outside the vehicle.**



## Automatically stored Last destinations



Fig. 183 Destination entry menu.

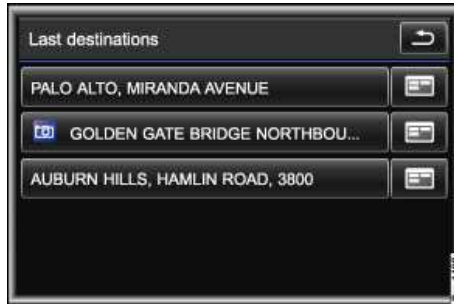

Fig. 184 List of recent destinations.

⚠ Please first read and heed the WARNINGS ⚠ note the introductory information and heed the WARNINGS ⚠

Destinations for which route guidance has been started are **automatically** stored in the **Last destinations** list ⇒ fig. 184.

Old *last destinations* are overwritten by new destinations when the list is full.

To permanently retain one of the *last destinations*, you need to store it manually in the **Directory**

### Last destinations list

- In the *Navigation* main menu, press the **New destination** function key ⇒ fig. 172.
- Press the **Last destinations** function key ⇒ fig. 183.
- Press the **[Edit]** function key next to an entry in the list to display further editing options.

**[Store]**: Stores the destination in the directory

**[Delete]**: Deletes the destination after further confirmation.

### Deleting all recent destinations

You can delete all entries in the **Last destinations** list at once.

- In the *Navigation* main menu, press the **Memory** function key
- In the pop-up window, press the **Manage memory** function key.

- In the **Manage memory** menu, press the **Delete all last destinations** function key and accept the confirmation dialog with **Delete**.

## User profiles and directory entries

**Please first read and heed the WARNINGS** ⚠ **note the introductory information and heed the WARNINGS** ⚠

A user profile is automatically created when a mobile phone is paired with the Infotainment System for the first time or a SIM card is inserted. Telephone directory entries are loaded and displayed in the **Directory** menu. The mobile phone or the SIM card is linked uniquely to the stored user profile.

Navigation destinations and directory entries, which are created manually while a user profile is active, are only assigned to that user profile and are only displayed when the corresponding mobile phone or SIM card is connected.

When the mobile phone or SIM card are connected to the unit again, the user profile is reloaded and the directory entries are displayed in the **Directory** menu.

Depending on the settings, only the directory entries for the loaded user profile are displayed in the **Directory** menu.

The directory is updated from the connected mobile phone on a regular basis. The update can also be started manually (**Import phone book**).

If you want a directory entry to also be displayed in the directory without a user profile being loaded, open the directory entry for editing and clear the check box in the **Private contact** function key

**i** User profiles can be deleted and renamed

**i** Directory entries with stored address data (postal address) can be converted into navigation destinations for route guidance

**i** There is no management and usage of user profiles in units without mobile phone package. All entries in the directory are currently accessible to all users if they are not deleted manually. Directory entries can be deleted individually from the directory or together using the factory settings

## Storing destinations manually



Fig. 185 Navigation main menu.



Fig. 186 Special destination detailed view.

ⓘ Please first read and heed the WARNINGS ⚠ note the introductory information and heed the WARNINGS ⚠

You can store destinations in the directory from different menus.

#### Function keys for storing destinations in selected navigation menus

Menu	Function keys and action
<i>Navigation</i> main menu ⇒ fig. 185.	Press  (flagged destination). The current position is stored as a flagged destination.
	Press <b>Position</b> and then <b>Store</b> to store the current position.
	Press <b>Store</b> and then <b>Store destination</b> to store the displayed destination.
Address entry ⇒ fig. 173.	Press <b>Save</b> .
<b>Last destinations</b> list ⇒ fig. 184.	Press  and then <b>Store</b> .
Special destination detailed view ⇒ fig. 186.	Press <b>Save</b> or .

After pressing the corresponding function key, the destination can be stored in the directory

## Storing in directory



Fig. 187 Storing in directory.



Fig. 188 Editing a directory entry.

**⚠ Please first read and heed the WARNINGS ⚠ note the introductory information and heed the WARNINGS ⚠**

- Select destination and press the function key to store

The **Store in directory** menu opens ⇒ [fig. 187](#).

### Storing in directory

- Press the **New directory entry** function key.
- **OR:** Press one of the stored directory entries to store the destination under this entry ⇒ [fig. 188](#).

If you selected **Create new entry**, the boxes for entering a name will be empty. If you have called up a stored directory entry, the name that was previously stored will be displayed ⇒ [fig. 188](#).

- Press the **Name** function key and enter a new name in an input window or change the existing name
- Change the displayed category by pressing the **Category** function key (Private **P** or Business **B**) ⇒ [fig. 188](#).

If you select a category under which an address is already stored, this address will then be overwritten without warning.

- If the check box in the **Display as favorite** function key is checked, the destination will also be stored in the **Favorites** list

- Press the **Store entry** function key to store the destination.

The destination is now stored under the entered name and the selected category in the **Directory** menu.

## Managing the directory



Fig. 189 Address book opened for editing.

**Please first read and heed the WARNINGS** ⚠ note the introductory information and heed the WARNINGS ⚠

When the **Directory** menu is open for editing, you can create new entries manually or import them from different sources (such as **Last destinations** list, memory card). Telephone directory entries for a connected mobile phone or a SIM card are also displayed in the directory

Depending on the settings, only the directory entries of the loaded user profile are displayed

### Opening Directory menu for editing

- In the *Navigation* main menu, press the **Memory** function key ⇒ fig. 185.
- In the pop-up window, press the **Manage memory** function key.
- In the **Manage memory** menu, press the **Directory** function key.

The **Directory** menu opens for editing ⇒ fig. 189.

### Options in Directory menu

- Press the **Options** function key ⇒ fig. 189.

**Settings**: Opens the **Directory settings** menu

**Search**: Opens an input window for finding a directory entry by entering an entry name

**New entry**: Opens a menu where you can manually enter a directory entry step by step

**i** If the **Directory** menu is called up via the destination input, only stored directory entries for which route guidance can be started are displayed ⇒ page 299. It is not possible to edit the directory entries via the destination input.

## Displays and options for directory entries



Fig. 190 Directory.

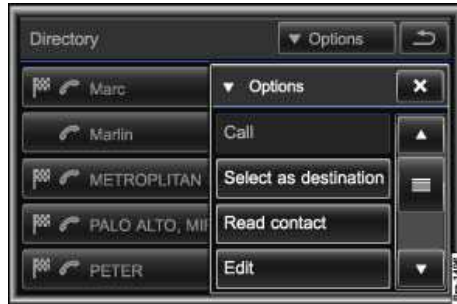

Fig. 191 Directory with a pop-up window for a directory entry.

⚠ Please first read and heed the WARNINGS ⚠ note the introductory information and heed the WARNINGS ⚠

- Open **Address book** menu for editing

### Symbols for directory entries

The symbols indicate what kind of information is stored for a directory entry ⇒ fig. 190.

📍 : Information is sufficient for route guidance.

☎ : A telephone number is stored.

### Calling up options for directory entries

- In the **Directory** menu, press the  function key next to a directory entry ⇒ fig. 191.

**Call**<sup>14</sup>: Makes a call to a stored telephone number.

**Select as destination**: Starts route guidance to a stored navigation destination

**Read contact**: The name of the directory entry is read out.

**Send by SMS**<sup>14</sup>: Sends the stored information as a business card by SMS.

**Delete**: Deletes the directory entry after confirmation.

---

<sup>14</sup> Only for directory entries of a connected mobile phone or a SIM card.

**Edit** or **Edit copy**<sup>14</sup>: Opens the directory entry for editing

## Editing directory entries

---

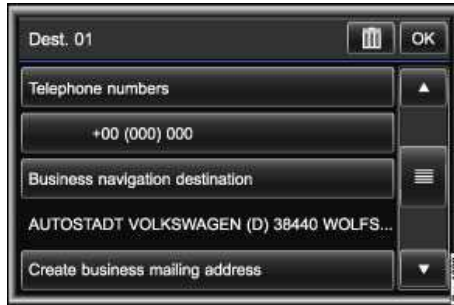

Fig. 192 Editing a directory entry.



Fig. 193 Navigation destination business opened for editing.

**⚠ Please first read and heed the WARNINGS ⚠ note the introductory information and heed the WARNINGS ⚠**

The navigation destinations, mailing addresses and telephone numbers, which were manually stored, created and imported using the **Directory** menu, can be changed and further information added.

### Displaying and editing directory entries

- Open **Address book** menu for editing
- Press the required directory entry.

All stored information for this directory entry and options for editing are displayed in a list ⇒ [fig. 192](#).

- Press the function key to modify stored information or add new information to the directory entry.

Information is entered or changed using input windows

### Function key: Effect

---

## Function key: Effect

---

**Last name**, **First name**, **Company**: Each open an input window to name the directory entry more precisely. The entries next to **Last name** and **First name** are used as voice commands.

---

**Create new telephone numbers**: Opens an input window where you can enter a telephone number manually.

---

**Create business navigation destination**: Opens a menu where you can select a navigation destination for the “Business ” favorites category or convert a stored mailing address into a navigation destination.

---

**Create business mailing address**: Opens a menu to enter a mailing address manually in input windows.

---

**Create private navigation destination**: Opens a menu where you can select a navigation destination for the “Private ” favorites category or convert a stored mailing address into a navigation destination

---

**Create private mailing address**: Opens a menu to enter a mailing address manually in input windows.

---

**Read contact**: The voice command stored under **Last name** and **First name** is read out

---

**Private contact**: The directory entry is only displayed when the corresponding user profile is loaded. If the check box  is cleared, the directory entry is transferred to the general user profile and is always displayed

If the prefix **Create ...** is **not** displayed in a function key, corresponding information is already stored. This information is displayed below the function key (such as in [fig. 192](#): **Business navigation destination**). Press the function key to display or modify the stored information ⇒ [fig. 193](#).

### Converting mailing addresses into navigation destinations

Information that is stored as **Business mailing address** or **Private mailing address** can be converted into navigation destinations, such as the telephone directory entries of a connected mobile phone.

- Press the **Create private navigation destination** or **Create business navigation destination** button.
- Press the **Create navigation destination** function key.

The mailing address is converted into a navigation destination in the Infotainment System and displayed in the **Address entry** menu where it can be edited further



- Touch the **OK** function key.

The mailing address is now stored as a navigation destination. The navigation destination is displayed and can be edited again.

- Press the **ESC** function key to close the menu.

## Favorite **\*F\*** and flagged destinations **F**



Fig. 194 Navigation main menu.

**⚠ Please first read and heed the WARNINGS ⚠ note the introductory information and heed the WARNINGS ⚠**

### Favorite destinations **\*F\***

For faster selection of a stored destination and to display it on the map, you can specify the option

**☑ Display as favorite** for frequently used destinations ⇒ [fig. 193](#).

The list of destinations stored as favorites is called up from the **Destination entry** menu using the **\*F\* Favorites** function key

Favorite destinations can also be called up from the map view using the assigned icon (private **F** or business **B**)

### Special case of flagged destination **F**

In the *Navigation* main menu, pressing the **F** function key stores the current vehicle position without further confirmation under the “**Flagged destination**” name.

Flagged destinations are stored in the directory under their respective creation date and can be re-named or have further details added like other directory entries

## Importing contacts or exporting them as “VCards”

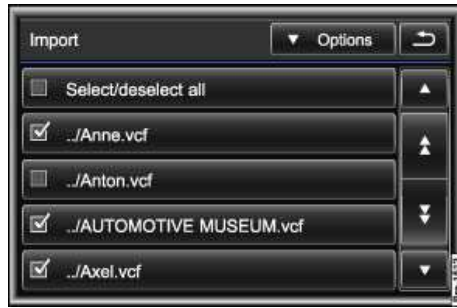

Fig. 195 Selecting the address (VCards) for the import.

**ⓘ Please first read and heed the WARNINGS ⚠ note the introductory information and heed the WARNINGS ⚠**

Contacts can be imported into the directory from a compatible data medium (memory card or USB storage medium) if they are stored in a VCard format compatible with the unit. A maximum of 100 contacts can be imported.

### Importing contacts (VCards) from a data medium

- Insert the data medium into the Infotainment System
- In the **Directory settings** menu, press the **Importing contacts** function key
- Following this, press to select the data medium.

The whole data medium is searched for contacts that can be imported. They are then displayed in a list → fig. 195.

- Select the contacts to be imported by pressing them .
- Press the **Options** function key.
- In the pop-up window, press the **Import** function key.
- Confirm the import message by pressing the **OK** function key.

### Exporting directory entries as VCards

All address book entries can be exported to a data medium such as a memory card. Directory entries from the currently connected mobile phone or the inserted SIM card can also be exported

- Insert the recordable data medium into the Infotainment System
- In the **Directory settings** menu, press the **Exporting contacts** function key
- Then select the data medium you wish to copy the contacts to by pressing on it.
- Select the contacts to be exported by pressing them in the directory .
- Press the **Options** function key.
- In the pop-up window, press the **Export** function key.

The folder “VCards” is automatically created on the data medium during the export. The exported contacts are stored in VCard format (“.vcf”) in this folder.

**ⓘ** Lists for importing or exporting contacts can be searched after pressing the **Search** function key in the **Options** pop-up window by entering the entry name (input windows).

 In some cases, an imported contact still needs to be converted for the navigation system

## Directory settings

---



Fig. 196 Address book opened for editing.



Fig. 197 Directory settings.

 Please first read and heed the WARNINGS  note the introductory information and heed the WARNINGS 

- Open **Address book** menu for editing
- Press the **Options** function key ⇒ fig. 196.
- In the pop-up window, press the **Settings** function key.

The **Directory settings** menu opens ⇒ fig. 197.

### Function key: Effect

---

**Memory capacity:** Indicates how many directory entries are stored in the current user profile and the general contacts.

---

**Sort by:** Defines the order and display of the directory entries.

---

## Function key: Effect

---

---

**Show general contacts**: Directory entries that are not assigned to a user profile are also displayed

---

**Delete profiles**: Press the profile to be deleted in the list of stored user profiles and accept the confirmation dialog with **Delete**.

---

**Change profile name**<sup>15</sup>: Renames currently loaded profile in an input window

---

**Read name tags**<sup>16</sup>: Reads out recorded name tags

---

**Delete name tags**<sup>16</sup>: Deletes recorded name tags

---

**Import directory**<sup>15</sup>: Starts an immediate import of directory entries from a connected mobile phone to the directory.

---

**Import contacts**: Imports navigation data (VCards) from an inserted data medium into the directory

---

**Export contacts**: Copies selected directory entries on an inserted data medium

---

---

<sup>15</sup> Only active when a mobile phone or a SIM card is currently connected to the Infotainment System  
⇒ page 360.

<sup>16</sup> Only active if name tags have been recorded for directory entries ⇒ page 240.

## Storing or editing the home address



Fig. 198 Menu: Destination entry.

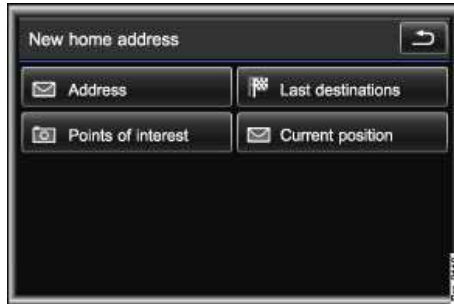



Fig. 199 Menu: New home address.

**⚠ Please first read and heed the WARNINGS ⚠ note the introductory information and heed the WARNINGS ⚠**

Only one address or position can be saved as the home address. The stored home address can be edited or deleted.

- In the *Navigation* main menu, press the  function key ⇒ [fig. 194](#).  
If a home address has already been stored, the route guidance will be started  
A message appears if the home address has not been stored.
- Confirm message to open **New home address** menu ⇒ [fig. 199](#).

### New home address menu

The **New home address** menu allows you to set a new destination as the home address ⇒ [fig. 199](#).

If a new home address is selected, the previously stored home address is overwritten.

If a home address has already been stored, it is shown and can be edited when the **Address** function key in the **Address entry** menu

### Opening the home address to edit it

- In the *Navigation* main menu, press the **New destination** function key ⇒ [fig. 194](#).
- In the **Destination entry** menu, press the **Home address** function key ⇒ [fig. 183](#).

The **Favorites - home address** menu with further feature keys opens.

**Start route guidance**: Starts route guidance to the stored home address.

**Show destination on map**: Shows the home address on the map.

**New home address**: Opens the **New home address** menu ⇒ [fig. 199](#).

**Delete home address**: Deletes the stored home address.

## Tour mode

### Introduction

---

In this section you'll find information about:

- Entering a stopover
- Selecting an additional destination and adding it to the tour
- Tour mode in the Navigation main menu
- Tour plan: creating or editing a tour
- Tour memory
- Leaving Tour mode

In Tour mode, multiple destinations can be travelled during route guidance ⇒ [fig. 204](#).



If a stopover is added or deleted during route guidance, the route guidance will then need to be started again in some cases.

A trip with multiple destinations is called a "Tour".

A tour always consists of **a destination** which is the end point of the tour and a **maximum of ten stopovers**.

#### Displaying starting point, destination and stopovers

The "starting point" of a tour is always the vehicle position determined by the navigation system (display: .

"Stopovers" are driven to before the destination and numbered in order (Display: no.  or no. .

The "destination" is the end point of a tour (display: .

#### More information:

- Safety information  for Infotainment System
- Basic information on use
- Introduction to navigation
- Destination input
- Destination guidance

### WARNING

Driving on today's roads demands the full attention of the driver at all times. Driver distraction causes accidents, collisions and serious personal injury!

- Never let yourself be distracted when setting, adjusting, or using the Infotainment System, when using your mobile phone, or when operating the mobile phone controls.
- Always drive attentively and responsibly. Use the Infotainment system, your mobile phone, and the mobile phone controls only if road, traffic, and weather conditions permit and you will not be distracted from your driving.
- If you cannot use the Infotainment System, your mobile phone, or the mobile phone controls safely while driving, wait until later or find a safe spot where you can pull off the road and park the vehicle.
- Always set sound volume levels so that you can clearly hear horns, sirens, and other warning sounds outside the vehicle.

## Entering a stopover

---



Fig. 200 Navigation main menu.

⚠ Please first read and heed the **WARNINGS** ⚠ note the introductory information and heed the **WARNINGS** ⚠

A stopover can be input once a destination has been defined. A stopover can also be entered during route guidance. The route guidance then needs to be started again in some cases.

- In the *Navigation* main menu, press the **Extras** function key ⇒ fig. 200.
- In the pop-up window, press the **Accept new stopover** function key.
- Confirm the subsequent query by pressing the **Stopover** function key.
- Select an additional destination and add it to the tour

### Finishing input of a stopover

After the first stopover has been selected, the *Navigation* main menu is automatically opened in tour mode ⇒ fig. 204.

The displayed **"New tour"** can be saved or edited further in the **tour plan**

## Selecting an additional destination and adding it to the tour

---



Fig. 201 Menu: Destination entry.



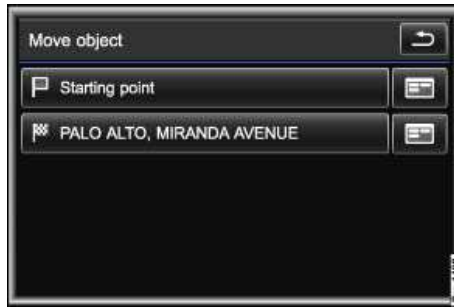

Fig. 202 Move object: Specifying the position for a new destination.

⚠ Please first read and heed the **WARNINGS** ⚠ note the introductory information and heed the **WARNINGS** ⚠

A new destination is selected as described for the destination entry

When the new destination has been sufficiently defined, a message appears that the order in which the destinations are to be driven to is to be determined.

- Press the **Next** function key.
- In the **Move object** menu, press the **Starting point** function key to add the destination as the first stopover ⇒ fig. 202.
- **OR:** Press another destination after which the new destination should be driven to.
- **OR:** Press the **...** function key to define the destination as the new destination.

The sequence in which the destinations will be driven can be changed subsequently in the **Tour plan** menu

## Tour mode in the Navigation main menu

---



Fig. 203 Navigation main menu.



Fig. 204 Navigation main menu in tour mode.

⚠ Please first read and heed the WARNINGS ⚠ note the introductory information and heed the WARNINGS ⚠

After the first stopover has been selected, the *Navigation* main menu is automatically opened in tour mode ⇒ fig. 204.

#### Manually switching to tour mode

It is possible to switch to tour mode manually from the *Navigation* main menu ⇒ fig. 203.

- Touch the **Extras** function key.
- In the pop-up window, press the **Tour mode** function key.

The *Navigation* main menu is opened in tour mode and the last destination is displayed in tour mode.

#### Editing within Tour mode

The tour is displayed in the upper third of the screen in the *Navigation* main menu ⇒ fig. 204. The name of the tour, the destination and the first stopover is displayed. Further destinations can be added to the displayed tour.

- Press the display box to show the entire tour in the **tour plan**
- **OR:** Press the **Destination entry** function key and confirm the subsequent query by pressing the **Stopover** function key.
- Select an additional destination and add it to the tour

## Tour plan: creating or editing a tour



Fig. 205 Tour plan menu: Tour with a stopover.

⚠ Please first read and heed the **WARNINGS** ⚠ note the introductory information and heed the **WARNINGS** ⚠

In the tour plan, an existing tour can be edited or a new tour can be created.

When a new tour is created, the tour displayed in the *Navigation* main menu is overwritten if it has not been stored

### Opening the Tour plan menu

- Change to tour mode
- In the *Navigation* main menu, press the **Extras** function key ⇒ fig. 204.
- Press the **New tour** function key in the pop-up window to create a new tour.
- **OR:** Press the **Edit tour** function key in the pop-up window to edit the displayed tour.

The **Tour plan** menu opens ⇒ fig. 205.

When a new tour has been created, only its starting point is specified (vehicle position). Otherwise, all destinations in the tour are displayed in the sequence in which they are driven to during route guidance.

### Displaying starting point, destination and stopover in the tour plan

Starting point: "□"

Stopover: "no. 📍" or "no. 📍"

Destination: "📍"

### Editing in the Tour plan menu

- If you press a destination displayed in the tour plan, it is then only possible to start route guidance to this destination ⇒ fig. 205.
- Press the **☰** function key following an entry to create a new tour or to edit the displayed tour.

A pop-up window containing editing options is opened:



**Details**: Opens the destination in the Detail view.

**Start**: Starts route guidance only to this destination

**Delete**: Deletes the destination from the tour plan.

**Move**: Makes it possible to move the destination in the tour plan ⇒ fig. 202.

**Add stopover**: Starts the process of selecting an additional destination

The **Starting point**  of a tour cannot be changed in the **Tour plan** menu. It is always determined by the current vehicle position. The **Add stopover**  function key is only available via the  function key.

- Press the  function key to close the tour plan. Changes are applied automatically.

## Tour memory

---





Fig. 206 Navigation main menu: Tour mode.

 Please first read and heed the **WARNINGS**  note the introductory information and heed the **WARNINGS** 

A newly created tour is always displayed with the name "**New tour**" ⇒ fig. 206. The tour needs to be stored in the tour memory otherwise it will be overwritten during editing or deleted when the tour mode is ended.



If changes to a stored tour are stored using the old tour name, this tour will be overwritten. If you do not wish to do this, save the tour under a different name.

### Storing a displayed tour

- In tour mode, press the **Memory**  function key ⇒ fig. 206.
- In the pop-up window, press the **Save tour**  function key.
- Enter a name for the tour being saved in the input window

Saved tours can be edited further in the **Tour plan**



### Calling up a stored tour

- In tour mode, press the **Memory**  function key.
- In the pop-up window, press the **Load tour**  function key.

The list of stored tours is opened.

- Press the name of a tour to display it in the *Navigation* main menu.
- **OR:** Press the function key  to display the tour in the detailed view.

### Managing stored tours

- In tour mode, press the **Memory**  function key.
- In the pop-up window, press the **Manage tour memory**  function key.
- In the **Manage tours** menu, press the **Delete all**  function key to delete all saved tours at once.

- **OR:** Press the **Change tour** function key to show all tours in a list and then press the  function key to rename or delete individual tours.

## Leaving Tour mode

---

 Please first read and heed the **WARNINGS**  note the introductory information and heed the **WARNINGS** 

A tour that has not been stored is deleted when you exit tour mode. The displayed tour can be stored before exiting

- Press the **Extras** function key ⇒ [fig. 206](#).
- In the pop-up window, press the **Leaving tour mode** function key.
- Confirm the following message with **Leaving**.

The *Navigation* main menu now only displays the destination defined as the end point in tour mode ⇒ [fig. 203](#).

## Waypoint navigation (Off-road mode)

### Introduction

---

In this section you'll find information about:

- Menu for waypoint navigation
- Plotting a waypoint tour
- Managing stored waypoint tours
- Driving a stored waypoint tour
- Stopping waypoint navigation

Waypoint navigation is a purely off-road feature as a means of orientation when driving in "Off-road areas" at low speeds.

Off-road areas are areas that do not have any street or off-road information. Streets, buildings and natural boundaries such as mountains and rivers will not be recognized even if they are shown on the map.

Waypoint navigation is **not** suitable for driving on normal roads. One-way streets, highway junctions and other such streets are not detected.

Autozoom **cannot** be activated in the map display.

#### More information:

- Safety information  for Infotainment System
- Basic information on use
- Introduction to navigation
- Destination input

#### WARNING

Using the Infotainment System while the vehicle is moving can distract you from the road and lead to accidents.

- Always drive attentively and responsibly.
- Select volume settings so that acoustic signals from the outside are audible (for example, the sirens of emergency rescue vehicles).

#### WARNING

Driving recommendations and traffic symbols displayed by the navigation system may differ from the current traffic situation.

- Traffic signs and traffic regulations have priority over the recommendations and displays provided by the navigation system.
- Always adjust your speed and driving style to road, traffic, weather, and visibility conditions.

## Menu for waypoint navigation

---



Fig. 207 Navigation main menu.



Fig. 208 Waypoint navigation menu with opened waypoint tour.

⚠ Please first read and note the introductory information and heed the WARNINGS ⚠

### Starting waypoint navigation

- In the *Navigation* main menu, press the **Extras** function key ⇒ fig. 207.
- In the pop-up window, press the **Off-road** function key.

The *Navigation* main menu is opened as the **Waypoint navigation** menu ⇒ fig. 208.

### Function keys in the waypoint navigation menu

#### Function key: Effect

---

##### **Memory**

**Load waypoint tour**: Opens a list for selecting a stored waypoint tour.

## Function key: Effect

**Manage tour memory**: Opens a menu for renaming or deleting stored waypoint tours.

## Waypoint tour

**New waypoint tour**: Starts plotting a waypoint tour

**Exit waypoint mode**: Closes waypoint navigation.

## Plotting a waypoint tour



Fig. 209 Plotting a waypoint tour.

⚠ Please first read and note the introductory information and heed the WARNINGS ⚠

A **waypoint tour** consists of a chain of automatically stored "waypoints".

### Starting recording

- In the **Waypoint navigation** menu, press the **Waypoint tour** function key ⇒ fig. 208.
- In the pop-up window, press the **New waypoint tour** function key.
- In the following input window, enter a name for the new waypoint tour

The system will start to record the route driven.

Points in the terrain can be marked by setting a manual waypoint.

- In the **Waypoint navigation** menu, press the **Mark current position in recording** function key.

Waypoints that have been set manually will be displayed on the map with a flag ⇒ fig. 211.

### Ending plotting

- In the **Waypoint navigation** menu, press the **Stop** function key.

After plotting, the stored tour is displayed in the **Waypoint navigation** menu ⇒ fig. 210.



## Managing stored waypoint tours

---



Fig. 210 Waypoint navigation menu with stored waypoint tour.

⚠ Please first read and note the introductory information and heed the WARNINGS ⚠

### Editing a waypoint tour

- In the **Waypoint navigation** menu, press the **Memory** function key ⇒ fig. 210.
- In the pop-up window, press the **Manage tour memory** function key.
- In the **Waypoint tour memory** menu, press the **Edit waypoint tour(s)** function key.
- Press the waypoint tour to display additional information.
- **OR:** Press the function key **⏏** to rename or delete the tour.

### Load waypoint tour

- In the **Waypoint navigation** menu, press the **Memory** function key.
- In the pop-up window, press the **Load waypoint tour** function key.
- Press the function key **⏏** in the list in order to see the waypoint tour in the detailed view.
- **OR:** Press the required waypoint tour directly in order to see it in the **Waypoint navigation** menu ⇒ fig. 210.

## Driving a stored waypoint tour

---



Fig. 211 Driving a waypoint tour in the map display.

⚠ Please first read and note the introductory information and heed the WARNINGS ⚠

### Starting route guidance

Before you start a waypoint tour, drive to the immediate vicinity of the required starting point.

- Load stored waypoint tour
- In the **Waypoint navigation** menu, press the **Start** function key ⇒ fig. 210.
- In the following menu, select how the waypoint tour should be driven.

“Starting” off in a stored route is not detected by the system automatically.

### Function key: Effect

---

**Reverse waypoint tour**: Reverses the direction of the displayed waypoint tour to be driven.

---

**From nearest**: Will start the waypoint tour from the nearest waypoint.

---

**Start whole tour**: Will start the entire waypoint tour. In the menu that follows you will have to select how the start point of the waypoint tour should be reached.

**On road**: The start point for the route guidance will be reached using public roads as far as possible.

**Off-road**: The start point for route guidance will be reached in off-road mode and any available roads will not be used.

When route guidance starts, the system will switch to the map view.

An audible signal is given when the starting point of the waypoint tour has been reached.

### During route guidance

Characteristics of the terrain are ignored during route guidance. A driving recommendation will be given about 55 yards (50 meters) before reaching a turning point. You should therefore drive slowly and follow recommendations for turning as far as possible!

Changes in the direction of travel will be given in relation to the current direction of travel, such as “Please travel in direction 9 o'clock!”.

The tendency of the direction of travel will be shown in the instrument cluster display using arrows.

### Stopping route guidance

- Press the Infotainment button **NAV** in the map display to open the **Waypoint navigation** menu.
- Press the **Stop** function key.

## Stopping waypoint navigation

---



Fig. 212 Waypoint navigation menu.

ⓘ Please first read and note the introductory information and heed the **WARNINGS** ⚠

- In the **Waypoint navigation** menu, press the **Waypoint tour** function key followed by the **Exit waypoint mode** function key.
- **OR:** Press the function key **New destination** and the function key **On road destination** in the menu that follows in order to open the **Destination entry** menu ⇒ page 299.

Any waypoint tour that is being recorded will be stored automatically if the waypoint navigation mode is closed.

## Route guidance

### Introduction

---

In this section you'll find information about:

- Route options
- Starting and stopping route guidance
- Provision of navigation recommendations
- Route guidance in tour mode
- Showing routes or a maneuver list
- Manually excluding the route section immediately ahead
- SIRIUS traffic reports (TRAFFIC)
- Display of traffic congestion and dynamic route guidance
- Displaying Sirius traffic reports in a list
- Navigation settings

After starting route guidance, the route is calculated according to the parameters in the routing options.

The unit switches to the map view. You are guided to your chosen destination by announcements and visual recommendations. Navigation messages are played back at the preset volume.

During route guidance all audio sources of the device are available.

#### **More information:**

- Safety information  for Infotainment System
- Basic information on use
- Introduction to navigation
- Destination input
- Tour mode



#### **WARNING**

**Driving recommendations can be different depending on the current situation, for instance if there are construction zones or out-of-date navigation data.**

- **Traffic signs and traffic regulations have priority over the recommendations from the navigation system.**
- **Always adjust your speed and driving style to road, traffic, weather, and visibility conditions.**

## Route options



Fig. 213 Navigation main menu.



Fig. 214 Routing options setup menu.

⚠ Please first read and heed the **WARNINGS** ⚠ note the introductory information and heed the **WARNINGS** ⚠

It is possible to exclude certain types of route and define route criteria for the calculation of the route. Routing options can be changed during route guidance. The route is then accordingly recalculated.

The route options that are currently active are indicated by the icons in the *Navigation* main menu. Inactive symbols do not indicate types of route that are not allowed.

- In the *Navigation* main menu, press the **Options** function key ⇒ fig. 213.

### 🔗 Route: Defining route options

- In the **Route options** menu, press the **Route** function key.
- Press the desired settings to select them in the pop-up window.

**Fast**: fastest route to the destination, even if this requires detours.

**Short**: shortest route to the destination, even if it results in a longer travelling time. The navigation route may include unusual route sections, such as dirt roads.

**Most economic**: calculates a mix between shortest route and shortest time.

Depending on the settings, 3 **alternative routes** corresponding with the selectable route criteria are displayed for selection after route guidance is started

### Dynamic route: Switching dynamic route guidance on or off

With this option, traffic reports can be taken into account in the route calculation

- In the **Route options** menu, press the **Dynamic route** function key.
- In the pop-up window, press the **On** or **Off** function key to enable or disable dynamic route guidance.

### Excluding or including types of route in the calculation

Press the **Highways**, **Ferries**, **Toll roads** and **Tunnels** function keys to activate or deactivate them. This makes it possible to define whether these types of route should be allowed for the route calculation or not.

If no reasonable route exists without the road type to be avoided, this road type will be nevertheless considered in the route calculation. For instance, if an island cannot be reached without using a ferry. For the calculation of very long routes, it is **not** possible to avoid highways.

## Starting and stopping route guidance



Fig. 215 3D map display during route guidance.



Fig. 216 Navigation main menu during route guidance.

**⚠ Please first read and heed the WARNINGS ⚠ note the introductory information and heed the WARNINGS ⚠**

After route guidance has started, the route to the first destination that meets the parameters in the **Route options** menu is calculated.

The unit switches to the map display ⇒ [fig. 215](#).

- Press the **NAV** Infotainment button or the **⊕...⊖...** function key to switch to the *Navigation* main menu.
- In the *Navigation* main menu, press the **NAV** Infotainment button or **MAP** function key to switch back to the map view.

The map is displayed in the most recently selected type (**2D** or **3D**). **3D** and “Autozoom” are activated by default

#### Alternative routes: Selecting a calculated route

In the **Navigation settings** menu, you can specify that 3 alternative routes are suggested on the map after the start of route guidance. These 3 routes correspond to the available route criteria *Fast*, *Short* and *Economical* route. **Route 1** corresponds to the current setting in this case.

- Select the required route by pressing on the right of the map.

The setting for the route criteria in the **Route options** menu is changed accordingly.

If no route is selected then route guidance starts automatically after about one minute, using the setting selected in the **Route options**.

#### Interrupting route guidance

Active route guidance can be stopped and later resumed from the new vehicle position at any time in the *Navigation* main menu.

- In the *Navigation* main menu, press the **Stop** function key ⇒ [fig. 216](#).
- Press the **Start** function key to continue route guidance ⇒ [fig. 213](#).

### Provision of navigation recommendations

---



[Fig. 217](#) 3D map display during route guidance.



Fig. 218 Visual navigation recommendations in the instrument cluster.

⚠ Please first read and heed the WARNINGS ⚠ note the introductory information and heed the WARNINGS ⚠

Navigation recommendations are provided in the form of navigation announcements and visual directions in the Infotainment System map view and on the instrument cluster display.

#### Displays in the Infotainment System map view

The red vehicle position indicator 📍 shows vehicle position and direction of travel ⇒ fig. 217.

During active route guidance, the route to be driven is indicated as a blue line.

Information on the journey time is displayed in the 🕒...🕒 function key.

📍 : Distance to the destination.

🕒 : Estimated time of arrival or driving time (**Navigation settings**).

Manually entered exclusions on the calculated route and are displayed.

Further information can be displayed in the route and maneuver list

#### Displays in the instrument cluster

After starting the route guidance, a street view is displayed in the instrument cluster by default for route guidance ⇒ fig. 218. At junctions in towns, travel direction arrows and a vehicle position indicator following the road are shown on a simplified section of the map 📍.

In the **Navigation settings** menu, you can select the classic view for route guidance in the instrument cluster. Then only travel direction arrows are displayed starting from the current direction of travel.

The distance to the next turning point is displayed in both views. In addition, a filling bar on the right of the screen graphically indicates the approach to the turn-off point. The road that you should turn into next is displayed at the top.

#### Navigation messages (acoustic driving recommendations)

After the route is calculated, an initial announcement is issued. Depending on the settings made, up to 3 navigation announcements are given before a turn, such as "Prepare to turn left", "Turn left in 325 yards (300 meters)" and "Now turn left".

- In the map view, briefly press the setting knob ⇒ fig. 131 (3) to repeat the last navigation announcement.

The distances that are announced depend on the type of road and your speed. On highways, the first announcement can be given about 1 1/4 miles (2,000 m) before an exit.

Appropriate announcements are also given on multi-lane roads, branching roads and at roundabouts, such as "Take the second exit from the roundabout".

When you reach your destination, you will hear a corresponding announcement, such as: "You have reached the destination".



### Acoustic driving recommendation settings

The volume of an acoustic driving recommendation can be adjusted to a predefined minimum and maximum volume using the volume control . All additional acoustic driving recommendations are issued at this volume.

The volume of audible navigation recommendations can be preset in the volume settings.

In the **Navigation settings** menu, you can switch off spoken navigation recommendations or define their level of detail.

Even when navigation information is switched off, you can show them briefly in the map view by pressing the setting knob => [fig. 131 \(3\)](#).



If a turn was missed during route guidance and there is no possibility to turn, continue driving until the navigation system offers an alternative route.



The quality of the announcements given by the unit depends on the navigation data provided.

## Route guidance in tour mode

---

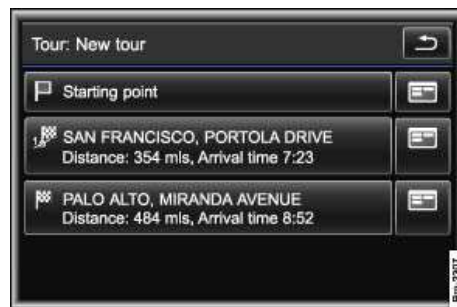

[Fig. 219](#) Tour plan in Tour mode.

 **Please first read and heed the WARNINGS**  **note the introductory information and heed the WARNINGS** 

Information about tour mode.

During route guidance, the information on driving time and arrival time refer to the next stopover.

When departing from a tour plan, the route guidance starts automatically for the next destination after reaching a stopover (announcement “You have reached the stopover”).

If a stopover cannot be reached accurately because, for example, it is located in a non-digitalized area, this destination must in some cases be deleted manually from the **Tour plan**.

- Press the display box of the tour in the *Navigation* main menu.
- In the **tour plan**, press the  function key following the stopover => [fig. 219](#).
- In the pop-up window, press the **Delete** function key.

If a stopover is added or deleted during route guidance, the route guidance will then need to be started again in some cases.

If route guidance to only one destination showed in the tour plan is started, only this destination is used and all other destinations of the tour plan will be ignored.

## Showing routes or a maneuver list

---



Fig. 220 Maneuver list in the split screen.

☑ Please first read and heed the WARNINGS ⚠ note the introductory information and heed the WARNINGS ⚠.

The route and maneuver lists can be displayed only during route guidance.

### Route list

- In the *Navigation* main menu, press the **Route** function key ⇒ fig. 216.
- In the pop-up window, press the **Route list** function key.

In the **route list** the street names or street designations of the route sections to be driven are displayed in a list.

Function keys with an arrow ► indicate that you can display further subsections for this route section.

- Press the ►... function key to display subsections.
- Press the ▼... function key to close the subsections view again.

### Maneuver list

The **Maneuver list** can be displayed in a separate window from the map view ⇒ fig. 220.

- Press the **Extras** function key in the map display.
- In the pop-up window, activate the check box in the **Split screen** function key.
- In the split screen, press the ►... function key at the top left.
- In the pop-up window, press the **Maneuver list** function key.

In the **Maneuver list** the next turning points are displayed in a list with travel direction arrows. In addition, points of interest and traffic congestion can be indicated by icons.

Street names or street designations refer to streets where turns are made.

**i** It takes a few seconds after route guidance has started for the route and maneuver list to be calculated so that it can be displayed.

## Manually excluding the route section immediately ahead

---

☑ Please first read and heed the WARNINGS ⚠ note the introductory information and heed the WARNINGS ⚠.

During route guidance, you can manually exclude the route section immediately ahead of your current location. The route exclusion is revoked when route guidance is stopped.

- In the *Navigation* main menu, press the **Route** function key ⇒ [fig. 216](#).
- In the pop-up window, press the **Avoid area** function key.

The **Avoid area** menu opens. The length of the stretch to be excluded from the current vehicle position.

- Press the **▲** function key to specify up to which route section the route ahead should be blocked.
- Press the **▼** function key to shorten the route exclusion.
- Press the **OK** function key to confirm the exclusion entry.

In the *Navigation* main menu ⇒ [fig. 216](#), the icon for an active route exclusion  is displayed.

The route is recalculated if a sensible alternative route can be calculated given the entered exclusion. In the map, the manually excluded stretch of road is shown by a red dotted line.

#### Manually revoking a route exclusion

- In the *Navigation* main menu, press the **Route** function key.
- In the pop-up window, press the **Remove** function key.

The route is recalculated if a route that saves time can be calculated after removal of the exclusion.

 Only **one** route exclusion can be entered manually.

## SIRIUS traffic reports (TRAFFIC)

---

 **Please first read and heed the WARNINGS  note the introductory information and heed the WARNINGS **

The current traffic conditions can be displayed on the map by symbols and the Sirius traffic flow displays

If dynamic route guidance is activated, reported traffic problems are taken into account in the route calculation

Sirius traffic reports are subject to subscription charges and may not be available in all locations. The subscription must be activated for use either by telephone or Internet using the unit-specific Sirius ID.

#### Displaying the SIRIUS-ID

- Press the **SETUP** Infotainment button ⇒ [fig. 131](#).
- Press the **Navigation** function key.
- Press the function key **SIRIUS traffic ID**.

The Sirius traffic ID and the Internet address and the telephone number of the Sirius activation hotline are displayed in the pop-up window.

- Press function key **OK** to close the pop-up window.

## Display of traffic congestion and dynamic route guidance



Fig. 221 SIRIUS traffic flow display and traffic congestion on the map.

ⓘ Please first read and heed the **WARNINGS** ⚠ note the introductory information and heed the **WARNINGS** ⚠

Reported traffic problems are indicated by colored symbols on the map: Familiar symbols are used to indicate traffic events, such as 🚗 for a traffic jam.

The positioning of a symbol indicates the start of the traffic congestion if this is clearly defined in the traffic message.

During route guidance, traffic congestion which is **not** on the calculated route, is shown in gray.

The length of a traffic hold-up on the calculated route is shown by a red and white dotted line.

- Press a traffic congestion symbol to display additional information.

Due to the map scale, one symbol on the map may indicate more than one traffic problem. If this is the case, a list of traffic problems at that location appears when you press the symbol.

### Dynamic route guidance

If a traffic problem affecting the route is reported during route guidance, an alternative route is calculated if the navigation system determines that it would save time. A navigation announcement also informs you if this is the case.

### Sirius traffic flow display

Traffic flow is monitored by cameras and sensors on some highways and main roads. The analyzed traffic flow data can be shown on the map as a traffic flow display => fig. 221.

**Green line:** Traffic flowing freely.

**Orange line:** Slow-moving traffic.

**Red line:** Queuing or stop-and-go traffic.

**No display:** Traffic flow display not available for this area.

ⓘ Avoiding a traffic jam as a result of reported traffic congestion may not necessarily save time if, for instance, there is also heavy traffic on the alternative route.

ⓘ The quality of dynamic route guidance depends on the stored navigation data and the traffic information provided by Sirius.

ⓘ The route ahead can also be excluded manually, to start a new calculation of the route

## Displaying Sirius traffic reports in a list

ⓘ Please first read and heed the WARNINGS ⚠ note the introductory information and heed the WARNINGS ⚠

- Press the **TRAFFIC** Infotainment button to display a list of the current traffic reports.

Traffic reports in the vicinity of the current vehicle position are displayed.

During route guidance, traffic congestion along the calculated route is shown at the top of the list and is indicated by a colored symbol. Other traffic jams are then indicated by a gray symbol.

- Press a traffic report entry to show the details.
- Press the arrow buttons in the detailed view in order to scroll through the traffic reports.

Traffic reports displayed in the detailed or list view can be read out by the Infotainment System.

- In the list view, press the function key at the top right to have all displayed traffic reports read out one after the other.
- While they are read out, you can press the **X** function key to stop the feature.

If another menu is opened using an Infotainment button, the list of traffic reports will be closed.

## Navigation settings



Fig. 222 Menu: Navigation settings.

ⓘ Please first read and heed the WARNINGS ⚠ note the introductory information and heed the WARNINGS ⚠

- Press the **SETUP** Infotainment button ⇒ fig. 131.
- Press the **Navigation** function key.

If the check box in a function key is checked , the feature is switched on

### Function key: Effect

**Suggest 3 alternative routes**: 3 **alternative routes** are displayed on the map following the start of route guidance

**Voice guidance**: Setting for the spoken navigation recommendations

## Function key: Effect

---

**Complete**: Detailed driving recommendations with lane recommendation and additional information.

**Compact**: Some additional navigation recommendations and information are left out.

**Off**: No spoken navigation recommendations.

---

**Time display**: Display  during route guidance.

**Arrival time**: The estimated time of arrival at the destination is displayed.

**Driving time**: The estimated driving time until reaching the destination is displayed.

---

**Map icons**: Select icons for display on the map

---

**Speed limit display**: The speed stored in the navigation data for the road you are currently travelling on is displayed on the map. The actual speed limit may differ from this display.

---

**Advanced navigation settings**: Allows settings for demo mode.

---

**SIRIUS traffic ID**: The Sirius traffic ID and the Internet address and the telephone number of the Sirius activation hotline are displayed in the pop-up window

---

**Instrument cluster guidance**: Visual navigation recommendations for guidance in the instrument cluster

**Arrow view**: Travel direction arrows show the direction of travel and the distance to the next turn-off point.

**Street view**: Road and route view corresponding with the map display in the Infotainment System.

---

## Function key: Effect

---

**Voice guidance during phone call**: Spoken navigation recommendations are also given during a telephone call.

### Advanced navigation settings: Demo mode and manual location

- In the **Advanced navigation settings** menu, check the check box in the **Demo mode** function key by pressing it  to start virtual route guidance to the entered destination.
- Press the **Enter current position manually** function key to select a manual location in the same way you entered a destination

If demo mode is enabled an additional pop-up window opens when you start route guidance.

- Pressing the **Demo mode** function key starts a “virtual route guidance” to the destination you have entered.
- If you press the **Normal mode** function key, a “real route guidance” starts.

The sequence of events and the operations in virtual route guidance are similar to those in real route guidance. Once a **manual location** has been entered, the virtual route guidance starts from that position.

Virtual route guidance is repeated when you reach the fictitious destination and always starts again from the starting point if it is interrupted.

When real route guidance is started following route guidance in demo mode, the unit first has to reorient itself. Depending on the number of currently received satellites, this orientation may take some time. Vehicle movement can reduce the re-orientation time.



If the vehicle is moved and the unit can determine its current location by GPS, any manually entered location will be overwritten with the current vehicle location.



Disable demo mode after use, otherwise you will be prompted to choose between virtual and normal route guidance each time you start route guidance.

## MAP (map display)

### Introduction

---

In this section you'll find information about:

- Overview of the map display
- Browsing and centering map
- Changing the scale and view
- Changing display type and displaying destination area
- Split screen in the map view
- Symbols and additional displays on the map
- Map settings: selecting map symbols

#### **More information:**

- Safety information  for Infotainment System
- Basic information on use
- Introduction to navigation
- Destination guidance

### Overview of the map display

---



**Fig. 223** 3D map display during route guidance.





Fig. 224 3D map display moved with vehicle position.

⚠ Please first read and heed the **WARNINGS** ⚠ and note the introductory information

The system automatically switches over to the map display when route guidance is started.

To switch manually to the map view, press the **NAV** Infotainment button repeatedly until the map view is displayed or, in the *Navigation* main menu, press the **MAP** function key ⇒ fig. 216.

The map display is shown with the most recently selected display type

Further screens can be displayed using the *split screen*

The red vehicle position indicator 📍 shows vehicle position and direction of travel. If the symbol 📍 turns gray and the map view “freezes”, it is currently not possible to determine the vehicle’s position, such as in a multi-story parking garage.

During route guidance, the route to be taken is shown as a blue line and instead of the **Destination** function key ⇒ fig. 224, the 📍...📍 function key is displayed ⇒ fig. 223.

- Press the **Destination** or 📍...📍 function key to switch to the *Navigation* main menu.
- Press the 📍 function key to show or hide the function keys in the bottom line of the screen.

#### Controlling audio source

The currently selected audio source is displayed in the fourth function key ⇒ fig. 224.

- Press the function key briefly to open a pop-up window for controlling the current audio source.

Some external media sources cannot be controlled.

#### Available options: **Extras** function key

**Day/night**: Changes between day and night design of map view.

**Split screen**: Shows or hides the *split screen*

**Display off**: Switches the display off. To switch on again, press any Infotainment button or touch screen.

## Browsing and centering map

---

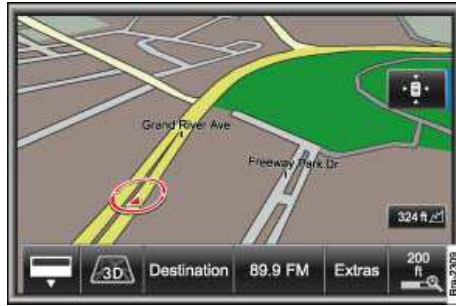

Fig. 225 3D map view (map section moved).

ⓘ Please first read and heed the WARNINGS ⚠ and note the introductory information

- In order to move the displayed map section, place your finger on the screen and, *without lifting it off*, drag it over the screen.

This function is used for “browsing the map” and, for example, looking for special or favorite destinations in the vicinity of the vehicle position 📍, which can be selected if necessary

### Showing vehicle position 📍 on map

The 📍 function key is displayed at the top right on the map if the screen section has been moved ⇒ fig. 225.

The map view no longer follows the vehicle position, instead it stays in the selected position.

- Press the 📍 function key to display the vehicle position 📍 on the map again.

While the map section is moved manually (display: 📍), autozoom remains disabled

## Changing the scale and view

---

ⓘ Please first read and heed the WARNINGS ⚠ and note the introductory information

- Turn the setting knob ⇒ fig. 131 (3) to change the map scale.

Additional function keys can be shown to change the map section and the map scale.

- Press the function key at the bottom right showing the currently selected map scale in order to show additional function keys.

The function keys are hidden after five seconds of inactivity.

- Press the 📏 or 📏 function key or move the slider 📏 in the scale to change the map scale.
- Press the 📏 function key to “zoom” the map display briefly into the map overview. After a few seconds, it returns automatically to the last selected scale.

### Display of start and end points on the map

- Press the 📍 function key to display the start and end points in an overview map.
- Press the active 📍 function key again to display the map in the original display type.

If autozoom is also enabled, the screen switches to a 2D crossroads view when you come to a junction.

## Autozoom



If Autozoom is active, the map scale is adjusted automatically, depending on the route (small scale for driving on the highway and a large scale for driving in town).

- Press the  function key to switch autozoom on or off.

When autozoom is reactivated, the screen automatically switches to the view of the current vehicle position .

Furthermore,  is displayed in the function key for showing the selected map scale => [fig. 226](#).

While the map section is moved manually => [fig. 225](#), autozoom remains disabled

- Press the  function key to display the vehicle position  on the map again.

## Changing display type and displaying destination area





[Fig. 226](#) 3D route guidance with autozoom.



[Fig. 227](#) 2D route guidance in the map overview (section moved manually).

 Please first read and heed the **WARNINGS**  and note the introductory information

The symbol shown in the second function key ,  or  shows the currently selected display type.

- Press the function key and press the map display type to select it => [fig. 226](#).

 **2D**: 2 dimensional, from above (conventional).

 **3D**: 3 dimensional, from the front at an angle (as would be seen approaching from an airplane).

: Destination view; shows the currently set destination  in the 2D map view.

## 2D: Setting orientation of map

- Press the  function key at the top right to change the map alignment for the 2D map display (facing north or direction of travel) => [fig. 227](#).

When autozoom is activated, the screen will be automatically oriented to the direction of travel at a junction.

The 3D map view is always shown in the direction of travel.

## Split screen in the map view

---



[Fig. 228](#) Maneuver list in the map display during route guidance.

### Please first read and heed the WARNINGS and note the introductory information

Further information can be displayed in the *split screen*. Information to support route guidance can be displayed while you are using the navigation system.

- In the map view, press the **Extras** function key and check the check box in the  **Extra wind.** function key by pressing it.
- Press the  function key at the top in the *split screen* to show further display options => [fig. 228](#).
- Select the desired display by pressing a function key.

**Maneuver list:** Maneuver list during route guidance

**Compass:** Compass view with current direction of travel and the current road being used.

**GPS viewer:** Current vehicle position in coordinates, altitude and GPS status (satellite reception).

**Off-road info:** Shows steering angle.

## Symbols and additional displays on the map

---



### Please first read and heed the WARNINGS and note the introductory information

Special and favorite destinations can be displayed as symbols on the map.

Reported traffic problems are also displayed by a symbol on the map

The display of symbols in the map can be activated or deactivated in the **Selection of map icons** menu



### Favorite destinations on the map

A favorite category can be specified for stored destinations. Favorite destinations can be displayed on the map with the orange favorite icon assigned to them (private  or business .

The list of favorite destinations is called up from the **Destination entry** menu.

### Points of interest on the map

Points of interest can be selected as a navigation destination.

Points of interest are divided into point of interest categories. These point of interest categories are assigned to blue point of interest icons (such as  hotel and  petrol station). A list of available point of interest categories can be called up from the **Map settings** menu. Map icons can be selected there for display.

### Display detailed information on points of interest

- Press the symbol on the map briefly to display a window with further information.

Due to the map scale, there may be several entries behind one symbol on the map, in which case a list appears for selecting an entry.

- Select the required entry by pressing.

Function keys for further operation are displayed in the information window that appears.

- Selecting points of interest and favorite destinations from the map
- TMC traffic reports on the map

### 3D models on the map

An abstract 3D city model can be displayed in the  **3D** display type for some cities (such as Berlin).

In addition, special historical buildings and sights of interest are displayed as photo-realistic 3D models.

To display these, autozoom needs to be switched off in some cases and you have to zoom further into the map

The display of 3D city models and 3D sights of interest is enabled and disabled in the map settings

 If no symbols or 3D models can be displayed due to the scale, turn the setting knob clockwise ⇒ [fig. 131 \(3\)](#) in order to zoom in on the map.

## Map settings: selecting map symbols

---

 Please first read and heed the **WARNINGS** and note the introductory information

- Press the **SETUP** Infotainment button ⇒ [fig. 131](#).
- Press the **Navigation** function key.
- In the **Navigation settings** menu, press the **Map icons** function key.
- In the **Selection of map icons** menu, check the check boxes in the function keys for display on the map .

### Function key: effect on map

---

---

**All**: Selects all available icons for display. Not recommended for cities.

---

## Function key: effect on map

---

**Traffic information**: TMC traffic reports are displayed as icons



---

**3D landmarks**: Photo-realistic 3D models of special historical buildings and landmarks are displayed<sup>17</sup>.



---

**3D city model**: Buildings in cities are displayed as abstract 3D models<sup>17</sup>.

---

 **Important destinations (business)**: Shows favorite destinations from the “business” category that were selected upon saving with 

---

 **Important destinations (private)**: Shows favorite destinations from the “private” category that were selected upon saving with 

---

**...**: Activated point of interest categories are displayed.

---

<sup>17</sup> Only available for some cities.

## Introduction

### Before using

---

**Before using the cellular telephone (mobile phone) control for the first time, carry out the following steps. This will enable you to use the mobile phone control safely and make full use of the functions it provides:**

✓	Follow the basic safety instructions  .	
✓	Familiarize yourself with the controls.	
✓	Read the instruction manual of the mobile phone or audio player you wish to pair with the unit.	

### Safety information

---

 <b>WARNING</b>	
<p>Driving on today's roads demands the full attention of the driver at all times. Driver distraction causes accidents, collisions and serious personal injury!</p> <ul style="list-style-type: none"><li>• Never let yourself be distracted when setting, adjusting, or using the Infotainment System, when using your mobile phone, or when operating the mobile phone controls.</li><li>• Always drive attentively and responsibly. Use the Infotainment system, your mobile phone, and the mobile phone controls only if road, traffic, and weather conditions permit and you will not be distracted from your driving.</li><li>• If you cannot use the Infotainment System, your mobile phone, or the mobile phone controls safely while driving, wait until later or find a safe spot where you can pull off the road and park the vehicle.</li><li>• Always set sound volume levels so that you can clearly hear horns, sirens, and other warning sounds outside the vehicle.</li><li>• Setting the sound volume too high may damage your hearing. This applies even if you are exposed to high volumes for short periods only.</li><li>• Your call may be cut off or you may be unable to make calls if you are in an area with no mobile phone network coverage, an area where the network is very weak or, in some cases, in a tunnel, garage or underpass. This also means that no emergency calls can be made.</li><li>• In some countries, an emergency call is supported only if the mobile phone is connected to the telephone control containing an "unlocked" SIM card with sufficient credit or if a valid SIM card is in the SIM card reader.</li></ul>	



### WARNING

The volume may suddenly get louder change when you switch media source or connect a new audio source.

- Always lower the volume before switching media source or connecting a new audio source.



### WARNING

A mobile phone on the seat, instrument panel or in other places can be thrown around the inside of the vehicle during a sudden braking maneuver, a crash or other accident and injure vehicle occupants.

- Never attach a mobile phone to, or place it on, a door, the windshield, or above or near the areas marked "AIRBAG" on the steering wheel, the instrument panel, and the seat backrests, or between these areas and the vehicle occupants. The mobile phone could cause serious injury in an accident, especially when the airbags inflate.



### WARNING

Always switch off the mobile phone when refueling and in areas with a risk of explosion. The electromagnetic radiation can cause sparks that can ignite fuel vapors and cause a fire.

- The mobile phone can automatically log itself into the mobile phone network again when the Bluetooth® connection to the telephone control is interrupted.



### WARNING

If a mobile phone not connected to an external aerial is used in the vehicle, electromagnetic radiation in the interior could exceed limit values. This also applies if the outside antenna is not installed properly.

- Heart specialists advise that mobile phones can adversely affect the way pacemakers work. Always keep the mobile phone and its integrated antenna at least 8 inches (20 cm) away from a pacemaker.
- Never carry a mobile phone that is switched on in the breast pocket directly over a pacemaker.
- If you suspect there may be interference with a pacemaker or other medical device, switch the mobile phone off immediately.



### NOTICE

- Your mobile phone and the telephone control must always be switched off in areas where special regulations apply and when the use of mobile phones is forbidden. Radiation from a switched-on mobile phone can interfere with sensitive technical and medical devices, potentially causing malfunctions or damage to the devices.
- High speeds, poor weather and road conditions as well as the network quality may impair telephone calls in the vehicle and lead to loss of connection.



## General information

---

When pairing a mobile phone with the telephone control using the hands-free profile (HFP) observe the information for use of a mobile phone in the vehicle without connection to the external aerial

Only use compatible Bluetooth® devices. Information on compatible Bluetooth products is available from your Volkswagen dealer or on the Internet.

Follow the operational instructions of the mobile phone and the accessory manufacturer.

You may experience poor reception or may be cut off in areas where the signal is weak.

Most electrical devices are shielded against RF (high-frequency) signals. In rare cases, however, electronic devices may not be shielded against high-frequency signals emitted by the telephone control. Interference may occur.



Some countries may have restrictions regarding the use of Bluetooth devices. Information can be obtained from the local authorities.



When connecting the telephone control with a device using Bluetooth, read the device's operating manual for detailed safety information. Use only Bluetooth-compatible devices.

## Description

### Introduction

---

In this section you'll find information about:

Bluetooth

Components of the telephone control

“Bluetooth audio” wireless communication interface

Adjusting the volume

Information and breakdown call

Some functions and settings are only possible when the vehicle is stationary and are not supported by all mobile phones.

#### **Description<sup>18</sup>**

The telephone control is, together with a compatible mobile phone, which is paired via Bluetooth rSAP, or with an inserted SIM card, a fully-fledged GSM car telephone system.

The telephone control described in this manual is approved for use in the following networks: GSM 850, GSM 900, GSM 1800 and GSM 1900.

You can connect up to 4 mobile phones to the Infotainment System using the telephone control and 3 Bluetooth profiles (rSAP, HFP and A2DP for audio playback)



Using a mobile phone in the vehicle may cause noise from the vehicle speakers.



Some networks might not support all language-dependent characters and services.

## Bluetooth

---

 **Please first read and heed the WARNINGS and note the introductory information**

#### **Bluetooth®**

Bluetooth technology is used to connect a mobile phone to the vehicle telephone control. A pairing process needs to be carried out once only to use the telephone control with a Bluetooth mobile phone.

Some Bluetooth mobile phones are detected and connected automatically when the ignition is switched on, provided a connection had been made previously. For this to happen, the mobile phone itself and the Bluetooth feature in the telephone must be switched on and all active Bluetooth connections to other units must be disconnected.

The Bluetooth wireless connection is free of charge.

Bluetooth® is a registered trademark of Bluetooth® SIG, Inc.

#### **Bluetooth profiles**

When a mobile phone is connected to the telephone control, data is exchanged via one of 3 Bluetooth profiles.

---

<sup>18</sup> country specific

- **Bluetooth remote SIM Access Profiles (rSAP)**<sup>19</sup>: The mobile phone must support rSAP. The telephone control does not use its own SIM card, but rather “borrows” the SIM data of the mobile phone via a Bluetooth connection. The mobile phone logs itself out of the GSM network and logs into the telephone control using the data from the “borrowed” SIM card. The telephone is then controlled exclusively via the controls in the vehicle. The mobile phone goes into standby mode. This Bluetooth profile allows all telephone control functions and the exterior aerial to be used to the full.
- **Bluetooth Hands-Free Profile (HFP)**: If a mobile phone is connected via HFP to the telephone control, you can make calls wireless via the hands-free system. Many other telephone control functions are *not* available. The vehicle's exterior aerial can thus *not* be used.
- **Advanced Audio Distribution Profile (A2DP)**: Bluetooth profile for transferring audio signals

 Volkswagen recommends pairing a mobile phone with the telephone control via Bluetooth-rSAP in order to use all telephone control functions.

## Components of the telephone control

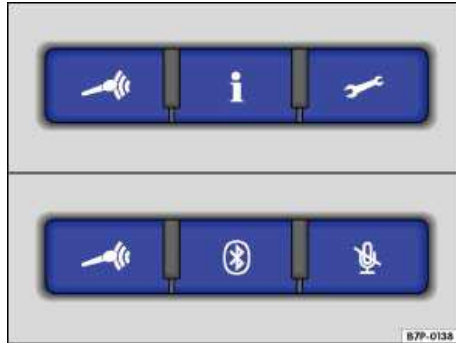







Fig. 229 3 button module in the roof: Controls for the telephone control.

 Please first read and heed the **WARNINGS**  and note the introductory information

Button	Effect
	Starting or ending voice operation
	<i>Press and hold for more than 2 seconds:</i> Information on the Volkswagen brand and on selected value-added services relating to traffic and travel
	<i>Hold down for more than 2 seconds:</i> Assistance from the Volkswagen dealership network in the event of a breakdown

<sup>19</sup> country specific

Button	Effect
	Make the telephone control briefly visible to Bluetooth devices
	Mute the microphone in the vehicle during a telephone call or cancel muting.

#### Components of telephone control<sup>20</sup>

- Cellular telephone (mobile phone) with Bluetooth® Remote SIM-Access-Profiles (rSAP) or separate SIM card<sup>21</sup>
- Infotainment System with touchscreen
- Multi-function steering wheel
- Instrument cluster display shows telephone functions
- 3 button module in the roof ⇒ [fig. 229](#).



#### NOTICE

To operate the telephone control, a light press of the button or light pressure on the feature keys on the screen is sufficient.

### “Bluetooth audio” wireless communication interface

 Please first read and heed the **WARNINGS**  and note the introductory information

Music stored on the mobile phone can be played back on the Infotainment System via the “**Bluetooth audio**” wireless communication interface.

Observe the notes on media mode and on operation during Bluetooth audio transmission.

In order to use “Bluetooth audio”, the mobile phone needs to support at least the Bluetooth profile “Advanced Audio Distribution Profile” (A2DP). A2DP is used for wireless transferring of stereo audio signals in high quality. If you wish to display track information on the instrument cluster and to control the audio playback via the Infotainment System the mobile phone must support the Bluetooth profile “Audio Video Remote Control Profile” (AVRCP).<sup>22</sup>

#### Making telephone calls during music playback via “Bluetooth audio”

All telephone functions are available during music playback via “Bluetooth audio”. During a telephone call or when other functions are carried out via Bluetooth, e.g. device search, the music playback is stopped.

#### Pairing a Bluetooth-enabled audio device

If you want to pair a Bluetooth-enabled audio device, for example an MP3 player, with the telephone control in addition to your mobile phone, please observe the following:

- Pair the Bluetooth-enabled audio device with the telephone control.

<sup>20</sup> country specific

<sup>21</sup> Available as an accessory Not provided with the vehicle.

<sup>22</sup> Depending on the mobile phone.

- To reconnect, deactivate the **Bluetooth audio (A2DP)** function in the **Bluetooth settings** menu.
- Connect a mobile phone.
- Activate **Bluetooth audio (A2DP)**.
- Connect audio device via A2DP.
- If necessary, change settings for A2DP on the mobile phone.<sup>22</sup>

 The volume can be changed directly on the mobile phone with several mobile phone models. Volkswagen recommends setting the volume to maximum on the mobile phone and adjusting the volume on the Infotainment System during operation.

 On a connected Bluetooth audio source, all warning and service tones, such as touch tones on a mobile phone, should be switched off to avoid interference and malfunctions.

 If the device is connected to the telephone control via A2DP, no other devices can be paired. The Bluetooth visibility of the telephone control deactivated for the duration of the active A2DP connection. This is not a fault in the telephone control. In order to pair further devices, deactivate the Bluetooth audio (A2DP) feature in **Telephone settings** and **Bluetooth settings** and activate it again after completing the pairing.

## Adjusting the volume

---

 Please first read and heed the **WARNINGS**  and note the introductory information

During a telephone call, the volume can be adjusted with the volume control of the Infotainment System, or with the buttons on the multi-function steering wheel. Settings on the mobile phone are not necessary.

On some mobile phones, the volume of the telephone control can be adjusted using the corresponding buttons on the phone.

### Adjusting the volume of the ring tone<sup>23</sup>

- Press the **SETUP** Infotainment button.
- Press the **Sound** function key and adjust the volume with the **Volume** and **Ring tone volume** function keys.
- Save the volume settings with the **OK** function key.

### Infotainment System

If the Infotainment System is switched off and the ignition is switched on, it will automatically be switched on for outgoing or incoming calls via the telephone control. The Infotainment System is switched off at the end of the call.

The radio broadcast or other music source is muted during an incoming or outgoing call so that the call is not disturbed by unnecessary background noise.

You can adjust the volume of an active call with the Infotainment System volume control.

### Navigation system

If route guidance is in use, you can switch navigation information off and on while you are making a telephone call via the **Navigation settings** menu

---



<sup>23</sup> With a connection via HFP, depending on mobile phone.

 The volume of the telephone control can only be adjusted if a mobile phone is paired or a SIM card is inserted in the SIM card reader<sup>24</sup>.

## Information and breakdown call

---

 Please first read and heed the **WARNINGS**  and note the introductory information

In certain countries, you can use the  and  buttons on the 3 button module to call the breakdown and service center of the Volkswagen Service Call Center. The system automatically connects you with the service center of your home country. A telephone connection can only be set up if a switched-on mobile phone is paired with the telephone control via Bluetooth

Volkswagen makes every effort to make these services available to you at the most reasonable price possible. Please inquire with a Volkswagen dealer regarding country-specific rates.

### Info call

The **Info call**  button offers information regarding Volkswagen and selected premium-rate services concerning traffic and traveling.

Press the  button for at least 2 seconds in order to establish the connection.

### Service call

**Roadside assistance** via the  button offers immediate assistance in the event of a breakdown. The Volkswagen dealership network with mobile service vehicles is at your disposal.

Press the  button for at least 2 seconds in order to establish the connection.

 A mobile network must be available for the Info and Service call. The services might not be available in some countries.

---

<sup>24</sup> country specific

## First steps

### Introduction

---

In this section you'll find information about:

Pairing a mobile phone via Bluetooth-HFP  
Automatic connection to a paired mobile phone

Some functions and settings are only possible when the vehicle is stationary and are not supported by all mobile phones.

Before the telephone control can be used with a mobile phone, a one-time pairing process with the mobile phone must be carried out to "connect" the units to each other. A user profile is created automatically in the telephone control which is clearly linked to the mobile phone and its SIM card. If a user profile already exists, replace or delete it.

A mobile phone can be paired with the telephone control using **Bluetooth HFP** or **Bluetooth-rSAP**<sup>25</sup>

Once the pairing process has been carried out, the telephone control will connect automatically with the "known" device via the Bluetooth connection when the ignition is switched on. If necessary, further settings can be made on the device for the Bluetooth connection.

All directory entries imported into the directory or created there are automatically assigned to the user profile.

#### Checklist

---

Before using (pairing) for the first time

- ✓ Switch on the mobile phone with Bluetooth.
  - ✓ Activate Bluetooth on the mobile phone.
  - ✓ Switch on Bluetooth visibility on the mobile phone.
  - ✓ Activate rSAP on the mobile phone<sup>25,26</sup>.
  - ✓ Close any Bluetooth connections on the mobile phone that are still active, i.e. that switch on automatically.
  - ✓ Deactivate the keypad lock and screensaver on the mobile phone.
- 

#### Checklist

---

To use the telephone

- ✓ Activate Bluetooth on the mobile phone.
  - ✓ Connect the mobile phone with the telephone control.
- 

---

<sup>25</sup> country specific

<sup>26</sup> Applies if rSAP is supported by the mobile phone.



## WARNING

Driving on today's roads demands the full attention of the driver at all times. Driver distraction causes accidents, collisions and serious personal injury!

- Never pair the mobile phone or configure user profiles while driving. Do this only when the vehicle is parked in a safe place.
- Never let yourself be distracted when setting, adjusting, or using the Infotainment System, when using your mobile phone, or when operating the mobile phone controls.
- Always drive attentively and responsibly. Use the Infotainment system, your mobile phone, and the mobile phone controls only if road, traffic, and weather conditions permit and you will not be distracted from your driving.
- If you cannot use the Infotainment System, your mobile phone, or the mobile phone controls safely while driving, wait until later or find a safe spot where you can pull off the road and park the vehicle.
- Always set sound volume levels so that you can clearly hear horns, sirens, and other warning sounds outside the vehicle.



For device search, select a location with the likelihood of only a few *unknown* Bluetooth devices, for example in the garage. The search range for Bluetooth is approximately 10 meters.

## Pairing a mobile phone via Bluetooth-HFP

⚠ Please first read and heed the WARNINGS ⚠ note the introductory information and heed the WARNINGS ⚠

Each mobile phone must be paired with the telephone control via Bluetooth once.

Linking takes several minutes. The first pairing can only be carried out when the ignition is switched on and the vehicle is stationary.

Read the operating manual for the mobile phone and prepare the mobile phone for pairing

Keep the mobile phone close to hand as you will need to operate it during the first pairing procedure between the telephone control and the mobile phone.

### Pairing procedure if no mobile phone has been paired with the telephone control yet

#### Step 1: Making the Bluetooth connection visible

- Activate the Bluetooth feature on the mobile phone.
- Switch the mobile phone to "device visible to all" The mobile phone will now be visible for a few minutes.<sup>27</sup> Repeat steps 1 and 2 as required if the time allowed expires without successful pairing.

#### Step 2: Bluetooth device search

- Switch on the ignition.
- Access the *PHONE* main menu with the **PHONE** Infotainment button.
- Press the **Search for telephones** function key.
- Confirm the query about whether Bluetooth has been activated on the mobile phone with **Next**.

#### Step 3: Pairing mobile phone

*There is a time limit for entering the password! Read through the whole of step 3 before carrying out all of the individual actions.*

---

<sup>27</sup> Depending on the mobile phone.



- If necessary activate "wait for incoming Bluetooth connections".
- Hold the mobile phone in your hand ready to enter the password within the time limit.
- Select the mobile phone from the device list in the vehicle by pressing the corresponding function key.
- Select the required pairing protocol below the mobile phone found.
- On the mobile phone, confirm the connection queries from the vehicle if required.
- Confirm the 4-digit password displayed on the Infotainment System screen.
- Enter the password **on the mobile phone within 30 seconds**.<sup>27</sup>.
- Confirm password entry.
- If necessary, confirm further queries on the mobile phone.

#### **Pairing procedure if a mobile phone has already been paired with the telephone control**

- Set the Bluetooth connection to visible on the mobile phone ⇒ step 1.
- Switch on the ignition.
- Access the SETUP main menu with the **SETUP** Infotainment button.
- Press the **Telephone** function key.
- Press the **Bluetooth settings** function key.
- In the **Bluetooth settings** menu, press the **Search for Bluetooth devices** function key.
- If necessary, confirm the query about whether Bluetooth has been activated on the mobile phone with **Next**.
- Carry out pairing as described ⇒ step 3.

#### **Failed pairing**

There is no limit on the number of attempts to pair the device with the telephone control.

Linking will not be successful if the password input time limit is exceeded or if the PIN code is entered incorrectly.

Restart linking if the process fails despite correct entries.

#### **Copying telephone directory to the telephone control**

Once pairing has been successfully completed, the telephone directory entries from the mobile phone<sup>27</sup> are loaded automatically into the data memory of the telephone control. Depending on the number of entries copied, the process can take several minutes.

The telephone directory memory of the telephone control is limited to 5000 entries. Each user profile can be assigned a maximum of 2000 entries as well as 100 user-created or edited entries.

### **Automatic connection to a paired mobile phone**

---

**⚠ Please first read and heed the WARNINGS ⚠ note the introductory information and heed the WARNINGS ⚠**

A mobile phone paired with the telephone control will be connected automatically to the telephone control when the ignition is switched on.

The telephone control always connects to the most recently paired device and the most recently used user profile.

If necessary, refer to the operating manual for the mobile phone for information on automatic Bluetooth connection (authorization). If necessary, switch on authorization for the telephone control on the mobile phone so that there are no queries about the connection between the mobile phone and telephone control.

The telephone control can be used as soon as the *PHONE* main menu is displayed on the Infotainment System screen.

When connecting automatically, the system will first search for the telephone that was last used in order to reconnect it with the telephone control. If this mobile phone is not in the Bluetooth range, the system will start to search for the mobile phone (user) that was used before it.

- Switch on the ignition.
- Enter the PIN code if it is not stored in the telephone control<sup>28</sup>.

#### **Requirements for automatic connection**

---

- ✓ The mobile phone needs to have already been paired with the telephone control.
  - ✓ The mobile phone must be switched on and contain a valid SIM card to make telephone calls.
  - ✓ Bluetooth must be activated on the mobile phone.
  - ✓ The mobile phone should have no connection to another Bluetooth device.
  - ✓ The mobile phone must be within the Bluetooth range of the telephone control.
  - ✓ The ignition must be switched on.
  - ✓ The mobile phone must have been *last* connected to the telephone control or another mobile phone connected via Bluetooth is no longer in the Bluetooth range of the telephone control or its Bluetooth feature has been switched off.
- 



If the automatic connection is made during an active telephone call, the telephone control can only make a connection via HFP. Change the Bluetooth connection to rSAP in order to use all telephone control functions.



If a Bluetooth connection cannot be set up even though all requirements are fulfilled or if the telephone control does not function “normally”, the mobile phone's system may have crashed. Remove the battery and insert again. Switch the mobile phone back on and try to establish a Bluetooth connection.



Volkswagen recommends not switching on authorization on the mobile phone so that you confirm the connection queries again before each automatic connection setup.

---

<sup>28</sup> country specific

## Basic functions

### Introduction

---

In this section you'll find information about:

PHONE main menu

Entering a telephone number and taking a call

#### WARNING

Driving on today's roads demands the full attention of the driver at all times. Driver distraction causes accidents, collisions and serious personal injury!

- Never let yourself be distracted when setting, adjusting, or using the Infotainment System, when using your mobile phone, or when operating the mobile phone controls.
- Always drive attentively and responsibly. Use the Infotainment system, your mobile phone, and the mobile phone controls only if road, traffic, and weather conditions permit and you will not be distracted from your driving.
- If you cannot use the Infotainment System, your mobile phone, or the mobile phone controls safely while driving, wait until later or find a safe spot where you can pull off the road and park the vehicle.
- Always set sound volume levels so that you can clearly hear horns, sirens, and other warning sounds outside the vehicle.

### PHONE main menu

---



Fig. 230 Telephone control main menu.



Fig. 231 Telephone main menu: Connection established.

ⓘ Please first read and heed the WARNINGS ⚠ note the introductory information and heed the WARNINGS ⚠

It takes a few minutes after the first pairing process until the telephone directory data from the paired mobile phone is available on the Infotainment System.

- Press the **PHONE** Infotainment button to open the *PHONE* main menu.

#### Display in the PHONE main menu

The name of the mobile phone network provider where the inserted SIM card or the SIM card of the paired mobile phone is registered is displayed in the center of the top line of the screen. The name of the paired mobile phone or the user profile being used is displayed in the second line (⇒ fig. 230: **FON 01**).

During a call, the telephone number or the name of the person you are talking to is displayed in the upper line if they are stored in the telephone directory, as well as the call duration ⇒ fig. 231.

The symbol ⓘ shows an existing Bluetooth connection.

The bars at the top right or bottom right indicate the current field strength (signal strength of the currently received mobile phone transmitter station).

#### Function keys in the PHONE main menu

##### Function key: Effect

---

: Accept, dial, or hold calls.<sup>29</sup>

---

: End call or reject incoming call.

---

**SOS**<sup>30</sup>: After you confirm a prompt, the emergency number is dialed, providing a connection can be made to a mobile phone network.

---

**Voice mail** and **Preset 2-6**: Speed dial buttons, one telephone number can be assigned to each button

---

<sup>29</sup> Country-specific valid only if conference/hold call/toggling active ⇒ page 387.

<sup>30</sup> Is not displayed on all units and is not supported by all mobile phone network providers.

## Function key: Effect

---

: Open the number pad to enter a telephone number

---

**Call lists**: Opens a pop-up window for selection of a call list for calls missed, dialed or received on the telephone control

---

**SMS**<sup>31</sup>: Opens a pop-up window with the following options:

**Inbox**: Displays received SMS.

**Templates**: Selection of available templates for sending SMS.

---

**Extras**: Opens a pop-up window with the following options:

**Display off**: Switches off the display. Press one of the Infotainment buttons or the screen to switch on again.

**Conference details**<sup>29</sup>: Opens a list of the parties in a current conference call

**Mute**: Switches the microphone off during a telephone call, so that the person on the line cannot hear what is being said in the vehicle.

---

: Opens the telephone directory of the paired mobile phone to select a telephone number

---



<sup>31</sup> Dependent on mobile phone and country.



## Entering a telephone number and taking a call



Fig. 232 Entering a telephone number.





⚠ Please first read and heed the WARNINGS ⚠ note the introductory information and heed the WARNINGS ⚠

- In the *PHONE* main menu, press the  function key ⇒ fig. 232.
- Entering a telephone number.
- Press the  function key to dial the number.

The special buttons “Asterisk”  and “Hash”  have the same functions as on a normal telephone.

### Entering a country code



To enter a country code, instead of the first 2 digits (international access code e.g. “00”) you can enter the character “+”.

- Press and hold the  function key until a pop-up window appears with the  and  function keys.
- Accept the  function key by pressing – the pop-up window is closed.

### Answering a call

An incoming telephone call is indicated in the top line of the screen by “Incoming call” and the caller's telephone number.

If the caller's telephone number is stored in the telephone directory, the caller's name is displayed

- Press the  function key to answer the call.
- Press the  function key to reject the call.

## Stored telephone numbers

### Introduction

---

In this section you'll find information about:

- Telephone directory
- Searching for an entry in the telephone directory
- Displaying and editing telephone number
- Call lists
- Storing telephone numbers to speed dial buttons

#### **! WARNING**

Driving on today's roads demands the full attention of the driver at all times. Driver distraction causes accidents, collisions and serious personal injury!

- Never let yourself be distracted if you use the telephone directory and its related functions while driving.
- Never let yourself be distracted when setting, adjusting, or using the Infotainment System, when using your mobile phone, or when operating the mobile phone controls.
- Always drive attentively and responsibly. Use the Infotainment system, your mobile phone, and the mobile phone controls only if road, traffic, and weather conditions permit and you will not be distracted from your driving.
- If you cannot use the Infotainment System, your mobile phone, or the mobile phone controls safely while driving, wait until later or find a safe spot where you can pull off the road and park the vehicle.
- Always set sound volume levels so that you can clearly hear horns, sirens, and other warning sounds outside the vehicle.

### Telephone directory

---



Fig. 233 Telephone directory.

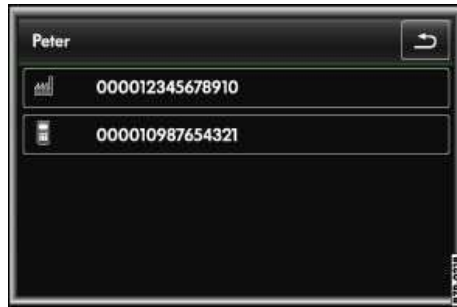

Fig. 234 Displaying a telephone directory entry.

⚠ Please first read and heed the WARNINGS ⚠ note the introductory information and heed the WARNINGS ⚠

It takes a few minutes after the first pairing process until the telephone directory data from the mobile phone is available on the Infotainment System.

The telephone directory can also be opened during an ongoing telephone call.

#### Assignment to a user profile

Telephone directory data, call lists and stored speed dial buttons are assigned to a user profile and stored in the telephone control. They are available when the corresponding SIM card or the mobile phone is connected with the telephone control again.

If telephone directory entries on the SIM card or the mobile phone have been changed, you can start a manual update of the telephone directory data via the **Directory settings** menu.

A **maximum of 4 user profiles** can be stored for mobile phones in the telephone control.<sup>32</sup> If you would like to pair an additional SIM card or a mobile phone, you have to delete a user profile first

#### Opening and searching the telephone directory

- In the *PHONE* main menu, press the function key to open the telephone directory ⇒ fig. 233.
- Press the arrow buttons to search through the telephone directory. Press the arrow button or move from entry to entry or press the double arrow button , to browse up or down page by page ⇒ fig. 233.
- If several numbers have been stored for one telephone directory entry, they can be displayed by pressing the entry ⇒ fig. 234. If only one number has been stored for an entry, a call is made to this number if the entry is pressed.
- **OR:** Press to look for a telephone directory entry on the on-screen keyboard ⇒ fig. 233.
- Press the entry open the detailed view ⇒ fig. 234.

#### Adding further telephone numbers to a telephone directory entry

- In the *Directory* menu, press the function key to the right of a telephone directory entry.
- Press the function key.
- Press the function key if the entry is stored in the mobile phone *and* as a copy in the telephone control.
- **OR:** Press functional button if the entry is stored *only* in the mobile phone.
- In the input window, enter the telephone number and confirm with .
- Confirm addition of the telephone number with .

<sup>32</sup> country specific



 The entries in the telephone directory of the mobile phone **cannot** be changed permanently via the telephone control. A telephone number stored in the telephone directory on the mobile phone can only be modified for calls from the vehicle. You can add a country code

 The telephone directory entries can be called up in the Navigation system via the **Directory** menu.

## Searching for an entry in the telephone directory



Fig. 235 Telephone directory.



Fig. 236 Search window for selecting a telephone directory entry.

 Please first read and heed the **WARNINGS**  note the introductory information and heed the **WARNINGS** 

- Open the telephone directory
- Press the **Search** function key ⇒ fig. 235.
- Enter the name you are looking for in the input window ⇒ fig. 236.

Each time you enter a character, the unit automatically suggests a complete name from the telephone directory corresponding to the character sequence you have entered ⇒ fig. 236. The number of matching results is displayed to the right of the entry field.

The use of upper and lower case letters makes no difference when searching for a telephone directory entry.

If no name is suggested as you enter text, there is no telephone directory entry matching the sequence of characters you have entered. Using the  function key, delete characters in the input line until a name is suggested again. Please take the sorting order into consideration

### Selecting displayed entry

Press the  function key to open the menu showing the search results that are still available  
⇒ [fig. 236](#).

 Using voice operation, you can also record the name stored in the telephone directory after the corresponding voice command

## Displaying and editing telephone number



---



**Fig. 237** Editing a telephone number.

 Please first read and heed the WARNINGS  note the introductory information and heed the WARNINGS 

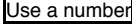
A telephone number stored in a call list can be changed before you dial it.

- Press the  function key next to a displayed telephone number or a displayed entry ⇒ [fig. 233](#).
- Press the  function key ⇒ [fig. 237](#).
- Press digits to enter them in the input line or press the  function key to delete digits in the input line.
- Press the  function key to dial the displayed telephone number.

After the telephone number has been dialed, it is then available in the call list of numbers dialed from the vehicle

 The entries in the telephone directory of the mobile phone **cannot** be changed permanently via the telephone control. A telephone number stored in the telephone directory on the mobile phone can only be modified for calls from the vehicle. You can add a country code, for example ⇒ [page 375](#).

## Call lists

---

 Please first read and heed the WARNINGS  note the introductory information and heed the WARNINGS 

You can save telephone numbers in the telephone control from calls that have been missed, dialed or received **in the vehicle**. Depending on the mobile phone model, call lists stored on the mobile phone could also be displayed.

- In the *PHONE* main menu, press the **Call lists** function key.
- Open a call list by pressing it in the pop-up window.

### Function key: Effect

---

---

**Missed calls**: Missed calls.

---

**Dialed Numbers**: Dialed telephone numbers.

---

**Received calls**: Received calls.

Incoming calls rejected with the  function key are stored in the call list of **received calls**<sup>33</sup>.

If a telephone number is stored in the telephone directory, the stored name is displayed instead of the telephone number.

- Press a telephone number or a name on the screen to dial it.
- Press the  function key to edit the telephone number or use it further.

Call lists are always specific to a user profile

### Storing telephone numbers to speed dial buttons

---

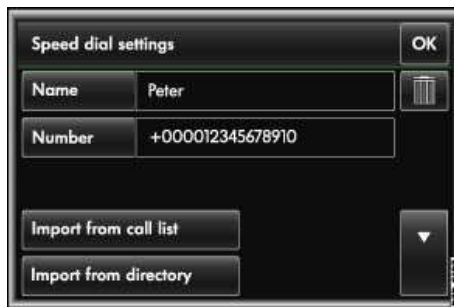

Fig. 238 Speed dial settings menu: Assignment of speed dial buttons.

---

<sup>33</sup> Depending on the mobile phone.



Fig. 239 Telephone control main menu: Newly assigned speed dial button.

⚠ Please first read and heed the WARNINGS ⚠ note the introductory information and heed the WARNINGS ⚠

The five speed dial buttons **Memory 2** to **Memory 6** can each be assigned a telephone number. The **Voice mail** speed dial button is reserved for the voice mail telephone number.

All speed dial buttons must be assigned manually (including **Voice mail**) and are specific to a user profile

#### Assigning speed dial buttons

- In the *PHONE* main menu, press a **free** speed dial button to open the *Speed dial settings* menu ⇒ [fig. 238](#).
- Press the **Number** function key to enter a telephone number manually.
- **OR:** Press the **Import from call list** or **Import from directory** function key select the required telephone number from the corresponding list.
- Having selected a telephone number, press the **Name** function key to assign a name to the speed dial button.
- Review all the details entered in the *Speed dial settings* menu ⇒ [fig. 238](#).
- Press the **OK** function key to apply all details entered and close the *Speed dial settings* menu.

In the *PHONE* main menu, the name you have entered is displayed in the speed dial button to which the respective telephone number is assigned ⇒ [fig. 239](#).

#### Dialing with speed dial buttons

- In the *PHONE* main menu, *briefly press* an **assigned** speed dial button to dial the telephone number stored to that button.

#### Editing assigned speed dial buttons

- In the *PHONE* main menu, *press and hold* an **assigned** speed dial button until the *Speed dial settings* menu opens.
- **OR:** Access the *Speed dial settings* menu with the **SETUP** Infotainment button and in the following order via the **Telephone** and **Speed dial** function keys.
- Press one of the function keys to edit its entry.
- To delete all entries for a speed dial button, press the **iii** function key.
- To close the *speed dial* menu without applying changes, press the **↩** function key.

## Functions during a telephone call

### Introduction

---

In this section you'll find information about:

During a call

Making an additional call, "toggling calls" and "call waiting"

Making a conference call

#### WARNING

Driver distraction can cause accidents and serious personal injury.

- Making telephone calls and carrying out functions while the vehicle is in motion can distract you from the road.

### During a call

---



Fig. 240 Telephone control main menu: Telephone call.





Fig. 241 Entering a DTMF button tone during a call.

 Please first read and heed the WARNINGS  note the introductory information and heed the WARNINGS 

When a connection is made to a dialed telephone number, the *PHONE* main menu changes to the *telephone call* view ⇒ [fig. 240](#).

#### Holding a call<sup>34</sup>

- Press the  function key to “mute” the current telephone call (display: **Call being held**).
- Press the  function key to resume the call.

While a call is being held, no sound is transmitted. Conversations in the vehicle cannot be heard by the other party.

#### Ending a telephone call

- Press the  function key to end the current call.

The *PHONE* main menu is displayed again ⇒ [fig. 239](#).

#### DTMF tones

Every telephone button has a specific DTMF tone assigned to it. DTMF tones are used, for example, to send a password or to select an employee in a call center or to access the voice mail.

- If you are asked to enter a sequence of characters during a telephone call, open the keypad by pressing the  function key and enter the characters ⇒ [fig. 241](#).

### Making an additional call, “toggling calls” and “call waiting”



[Fig. 242](#) Telephone call with call on hold.

 **Please first read and heed the WARNINGS**  **note the introductory information and heed the WARNINGS** 

During a telephone call, it is possible to make or take an additional call. You can switch between 2 calls (“toggling”)<sup>35</sup>.



#### Making a second call while telephoning

- Press the  function key during a call to put your current call on “hold”.
- Set up another call by entering a telephone number or selecting a stored telephone number.
- Once the additional call is connected, you can switch between the 2 calls (toggling).

<sup>34</sup> Country-specific valid only if conference/hold call/toggling active ⇒ page 387.

<sup>35</sup> Country-specific valid only if conference/hold call/toggling active ⇒ page 387.



### “Call waiting”: accepting an additional incoming call

- If another party calls while you are already on the telephone, the new caller's telephone number or name appears in the second line of the screen (display: **Waiting**).
- To reject the new call, press the  function key in the **Waiting** line.
- **OR:** To take the new call as an additional call, press the function key  in the **Call on hold** line.

If you take the new call, the first call is put on hold, but not ended (in  $\Rightarrow$  fig. 242: **Call being held**).

### “Toggling”: changing between 2 parties

While you have 2 active calls, **Call being held** is shown in the line of the party who is on hold.

- Press the  function key in the **Call being held** line to resume this call and put the other call on “hold”.
- **OR:** To end one of the calls, press the function key  in the line for that call.

During any call, it is only possible to hold one additional call. Several parties can be brought together in a conference call  $\Rightarrow$  page 384.

 If functions such as “toggling” and “conference” are used, the active call is shown first. If a call in the list is ended, the order of the calls in the list could be refreshed.

## Making a conference call



Fig. 243 Adding another party to a conference call.

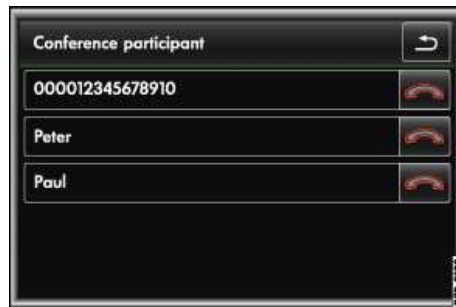



Fig. 244 Detailed view of a conference call.

 Please first read and heed the WARNINGS  the introductory information and heed the WARNINGS 

A call “on hold” can be brought into the active call to form a conference call<sup>36</sup>.

### Combining several calls to form a conference call

All parties in a conference call can hear and talk to each other.



- Press the  function key in front of the currently active call to join the 2 calls and form a conference call.

On the screen, the 2 parties are combined into one line labelled “**Conference call**”.



- You can now make or take an additional call and add the new party to the existing conference call by pressing the  function key.
- **OR:** You can toggle between the new call and the conference call

During a conference call, no more than **one** additional call to a separate party can be maintained ⇒ [fig. 243](#).

### Managing parties in a conference call<sup>36</sup>

- During a conference call, press the  function key ⇒ [fig. 243](#).
- In the pop-up window, press the  function key.

The list of parties in the conference call will be displayed ⇒ [fig. 244](#).

- To close the connection to one of the parties, press the  function key.
- Press the  function key to leave the list of parties in the conference call.

---

<sup>36</sup> Country-specific valid only if conference/hold call/toggling active ⇒ page 387.



# Settings

## Introduction

In this section you'll find information about:  
Overview of Telephone settings menu  
Call options  
Overview of Bluetooth settings menu

### **! WARNING**

**Driver distraction can cause accidents and serious personal injury.**

- Only adjust settings for the telephone control and carry out functions while the vehicle is stationary.

**i** Some functions in the **Telephone settings** menu are only available when a mobile phone is paired or if the mobile phone is paired with the telephone control via Bluetooth rSAP<sup>37</sup>.

## Overview of Telephone settings menu



Fig. 245 Settings main menu.

**! Please first read and heed the WARNINGS ! note the introductory information and heed the WARNINGS !**

### Opening the Telephone settings menu

- Press the **SETUP** Infotainment button ⇒ fig. 131.
- In the **Settings** main menu, press the **Telephone** function key ⇒ fig. 245.

<sup>37</sup> country specific

## Function key: Effect

---

**Telephone ID**<sup>38</sup>: Display of IMEI (telephone ID, serial number). If a mobile phone is paired via Bluetooth rSAP or a SIM card is inserted in the SIM card reader, the telephone ID of the telephone control will be displayed. If a mobile phone is paired via Bluetooth HFP, the telephone ID of the mobile phone is displayed ⇒ *Bluetooth profiles*.

---

**Call options**: Function settings for telephone calls that are made via the telephone control

---

**SIM PIN settings**<sup>38</sup>: Setting for use of the SIM PIN for the connection with a mobile phone.

---

**Speed dial buttons**: Set the telephone numbers for the speed dial buttons

---

**SMS settings**<sup>38</sup>: Setting for receiving and sending SMS from the vehicle.

---

**Call forwarding**<sup>38</sup>: Setting for forwarding incoming calls.

---

**Automatic network selection**<sup>38</sup>: Available mobile phone networks are displayed and can be selected. Logging on may not be possible due to restrictions for the SIM card being used. If the user profile is changed, the setting is reset to **automatic** if necessary.

---

**Switch off telephone**<sup>38</sup>: Switch the telephone control on or off.

---

## Call options

---

Please first read and heed the WARNINGS  note the introductory information and heed the WARNINGS 

## Function key: Effect

---

---

<sup>38</sup> country specific

## Function key: Effect

---

**Call waiting**<sup>39</sup>: You are informed about an incoming call during a telephone call visually and audibly.

---

**Show my number for outgoing calls**<sup>39</sup>: Setting defining whether your own telephone number is displayed to the person you are calling or is suppressed. This function is not supported by all mobile phone network operators.

---

**Automatic redial**<sup>39</sup>: A telephone number is automatically dialed up to five times when the line is busy.

---

**Automatic call acceptance**: Automatic pickup of an incoming call after the third “ring”.

---

**Caller ID**: Anonymous display of the telephone number or the name on the Infotainment System screen for outgoing and incoming calls.

---

**Conference call/Hold call/Call waiting**<sup>39</sup>: Enables “Hold”, “toggling” and conference functions. In certain mobile phone networks, this feature can cause the call to break up or result in functional problems.

## Overview of Bluetooth settings menu

---

ⓘ Please first read and heed the **WARNINGS** ⚠ note the introductory information and heed the **WARNINGS** ⚠

- Press the **SETUP** Infotainment button ⇒ [fig. 131](#).
- In the **Settings** main menu, press the **Bluetooth** function key ⇒ [fig. 245](#).

### Bluetooth settings

## Function key: Effect

---

**Search telephone**: Search for visible mobile phones within range of the telephone control.

---

---

<sup>39</sup> country specific

## Function key: Effect

---

**Search for audio player**: Search for visible Bluetooth audio players within range of the telephone control.  **Bluetooth-Audio (A2DP)** must be activated in the **Bluetooth settings** menu

---

**Search for all Bluetooth devices**: Search for visible Bluetooth devices within range of the telephone control.

---

**Bluetooth settings**: Press to open **Bluetooth settings** menu

### Bluetooth settings

## Function key: Effect

---

**Bluetooth**: Switch the telephone control Bluetooth feature on and off with the  function key. The  symbol is displayed in the *PHONE* main menu when the feature is enabled ⇒ [fig. 230](#).

---

**Visibility**: Switch the telephone control Bluetooth visibility on and off with the  function key. The visibility needs to be switched on to pair a mobile phone with the telephone control. The visibility feature will be switched off automatically after 3 minutes after the engine is started when **Automatic** is set.

---

**Bluetooth audio (A2DP)**: This feature needs to be activated if you want to connect a Bluetooth audio player to the telephone control

---

**Name**: Display or edit the device name of the telephone control. When the telephone control is set to visible, its name will be displayed on other Bluetooth devices following a device search

---

**Bluetooth device list**: Displays paired devices. Currently connected devices are indicated by the  symbol. If you press the function key of a device in the list, further settings can be displayed or changed in the submenu:

**Delete device**: Deletes the user profile for the selected device.

## Function key: Effect

---

**Car phone**<sup>40</sup>: Device paired via Bluetooth rSAP ⇒ *Bluetooth profiles*. Press the function key to make a connection; for instance, to switch from HFP to rSAP

**Hands-free function**: Device paired via Bluetooth HFP Press the function key to set up a connection.

**Audio player**: Device paired via Bluetooth A2DP. Press the function key to also pair a paired mobile phone with the telephone control as an audio player.

---

**Delete all external devices**: Deletes all paired devices after confirmation.

---

**Display recently found devices**: Displays the devices most recently found by the telephone control.

---

<sup>40</sup> country specific

# Starting and stopping the engine

## Introduction

---

In this section you'll find information about:

Warning and indicator lights  
Vehicle key positions in the ignition switch  
Starter button  
Starting the engine  
Stopping the engine  
Electronic immobilizer

### **Immobilizer display**

If an unauthorized vehicle key is used or the system malfunctions, **Immobilizer active!** may appear on the instrument cluster. The engine cannot be started.

### **Push-starting and tow-starting**

For technical reasons, **never** try to push-start or tow-start the vehicle. Jump-start the vehicle instead while following proper and safe procedures.

### **More information:**

- Vehicle key set
- Shifting
- Braking and parking
- Steering
- Hybrid drive
- Starting assistance systems
- Refueling
- Fuel
- Emergency closing and opening
- Jump-starting
- Towing



### **WARNING**

Switching off the engine while the vehicle is moving can make the vehicle harder to stop and result in loss of vehicle control, leading to collisions and severe personal injuries.

- Brake and steering assistance systems, the airbag system, safety belt pretensioners, and other vehicle safety features only work when the engine is running.
- Switch off the engine only when the vehicle is not moving.

**⚠ WARNING**

To reduce the risk of serious personal injury when starting and running the vehicle's engine:

- Never start the engine or let it run in a confined or enclosed area. Engine exhaust contains carbon monoxide, a poisonous, colorless, and odorless gas. Carbon monoxide can cause unconsciousness and death.
- Never leave the vehicle unattended with the engine running. The vehicle could move suddenly or some other unexpected event could occur resulting in property damage or personal injury.
- Never use starting assist fluids. Starting fluids can explode and can cause a “run-away” vehicle condition.



**⚠ WARNING**



The vehicle exhaust system and the catalytic converter or diesel particulate filter get very hot. They can cause fires and serious personal injury.

- Never park the vehicle where the hot exhaust system or catalytic converter could ignite flammable materials, such as brush, leaves, dry grass, spilled fuel, etc.
- Never apply additional undercoating or rust proofing on or near the exhaust manifold, exhaust pipes, catalytic converter, diesel particulate filter, or heat shields.

**Warning and indicator lights**

📖 Please first read and note the introductory information and heed the WARNINGS ⚠

Lights up	Possible cause	Proper response
	Ignition malfunction.	Get professional assistance
	Electronic immobilizer active.	Use an authorized remote control vehicle key
	Ignition switch or starter button (Keyless Access) malfunction.	Have the system checked immediately by a qualified workshop.
	Battery in remote control vehicle key is dead.	Replace the battery; get an authorized Volkswagen dealer or an authorized Volkswagen Service Facility to assist you.
	Glow plug preheating before diesel engine start-up.	

Lights up	Possible cause	Proper response
	Depress brake pedal!	Depress the brake pedal while starting the engine.
<b>READY</b>	Hybrid vehicles: Electric drive is ready.	Never leave the vehicle parked in the ready position. Remove the remote control vehicle key out of the ignition or for vehicle with Keyless Access press the starter button. When leaving the vehicle always take the remote control vehicle key with you.
	No authorized remote control vehicle key found (Keyless Access).	Use an authorized remote control vehicle key
	Engine cannot be started with starter button (Keyless Access).	Start the engine with the remote control vehicle key. Take the vehicle to an authorized Volkswagen dealer or an authorized Volkswagen Service Facility and have the system checked.

When the ignition is switched on, several warning and indicator lights come on briefly for a function check. They go out after a few seconds.

### **WARNING**

Failure to heed warning lights and instrument cluster text messages can cause the vehicle to break down in traffic and result in a collision and serious personal injury.

- Never ignore warning lights or text WARNINGS.
- Always stop the vehicle as soon as it is safe to do so.
- Whenever stalled or stopped for repair, move the vehicle a safe distance off the road, turn on the emergency flashers, stop the engine, and use other warning devices to warn approaching traffic.

### **NOTICE**

Failure to heed warning lights or text WARNINGS can result in vehicle damage.



## Vehicle key positions in the ignition switch

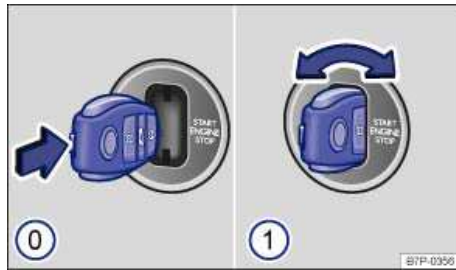

Fig. 246 In the ignition switch: Vehicle key positions.

**⚠ Please first read and note the introductory information and heed the WARNINGS ⚠**

(0) If there is no vehicle key in the ignition, the steering column is locked.

(1) *Brake pedal not depressed:*

Turn the ignition switch either clockwise or counterclockwise to switch the ignition on, and the steering column lock is disengaged. Diesel engine is preheated. Vehicle key **cannot** be removed from ignition switch.

*Press the brake pedal:*

Ignition is switched on, steering column lock is disengaged and the motor is started. Diesel engine is preheated. vehicle key **cannot** be removed from ignition switch.

Ignition switched on, engine is started. Diesel engine is preheated. vehicle key **cannot** be removed from ignition switch.

On *Hybrid vehicles* depending on the environmental conditions and the current operating state of the vehicle, either the combustion engine will be started or pure electric departure will be enabled. This leaves the combustion engine off for the time being. In both cases, the vehicle **READY** indicator will be displayed in the instrument cluster ⇒ table

To stop the engine, again turn the vehicle key to the left or right and release. vehicle key can then be removed from ignition switch.

To switch off the engine, turn the vehicle key either clockwise or counterclockwise and release. The vehicle key can be removed from the ignition switch when the transmission shift lever is in the **(P)** position.

### If you use the wrong key

If an unauthorized remote control vehicle key has been inserted into the ignition switch, it can be removed as follows:

- The vehicle key cannot be removed from the ignition unless both the key and the selector lever have been moved to the correct position. Press the release button on the transmission selector lever, move the selector lever to the Park **(P)** position and release the button. The vehicle key can now be removed.

## WARNING

Improper use of vehicle keys can result in serious personal injury.

- Always take the key with you when you leave the vehicle. The engine can be started and vehicle systems such as the power windows can be operated, leading to serious personal injury.
- Never leave children, disabled persons, or anyone who cannot help themselves in the vehicle. The doors can be locked with the remote control vehicle key. This could result in people being trapped in the vehicle in an emergency. For example, depending on the time of year, people trapped in the vehicle can be exposed to very high or very low temperatures.
- Heat build-up in the passenger and luggage compartment of a parked vehicle can result in temperatures in the vehicle that are much higher than the outside temperatures, particularly in summer. Temperatures can quickly reach levels that can cause unconsciousness and death, particularly to small children.
- Never remove the key from the ignition switch while the vehicle is moving or rolling to a stop. The steering wheel will lock and you will not be able to steer or control the vehicle.

 Leaving the key in the ignition for a long time when the engine is not running will drain the vehicle battery.

 Leaving the selector lever for a long period of time in any position other than Park (P) when the ignition is switched off can drain the vehicle battery.

 The vehicle key can be removed from the ignition switch only when the transmission is in Park (P). You may have to press the release button on the transmission selector lever to put the lever into Park (P).

## Starter button

---



Fig. 247 In the front center console: Starter button of the Keyless Access locking and starting system.

 Please first read and note the introductory information and heed the WARNINGS 

The starter button can only be used when an authorized vehicle key is in the vehicle.

### Engaging and releasing the steering lock

- Push the starter button *once* briefly to release the steering lock and turn on the ignition, without pressing the foot brake ⇒ .
- Push and starter button **again** to turn the ignition off again. The steering lock is unlocked.

If you happen to press the starter button while trying to lock the steering lock while the ignition is still on, a chime will sound when the driver door is opened. At the same time, a message appears in the instrument cluster display informing you that the ignition is still active.

### Switching the ignition on and off

- Push the starter button *once* to switch on the ignition without depressing the brake pedal ⇒ .
- Push the starter button *again* to switch off the ignition.

When the ignition is switched on, a chime will sound when the driver door is opened. At the same time, a message appears in the instrument cluster display informing you that the ignition is still active.

### Starting and stopping the engine

- Depress the brake pedal.
- Push the starter button to start the engine.
- Push the starter button *again* to stop the engine.

#### **WARNING**

Unintended vehicle movement can cause serious personal injury.

- Do *not* depress the brake pedal when switching on the ignition, as the engine could otherwise start immediately.

#### **WARNING**

Improper use of vehicle keys can result in serious personal injury.

- Always take the key with you when you leave the vehicle. Children or unauthorized persons may use it to lock the vehicle, start the engine, and operate vehicle systems such as the power windows, leading to serious personal injury.
- Never leave children, disabled persons, or anyone who cannot help themselves in the vehicle. The doors can be locked using the remote control vehicle key. This could result in people being trapped in the vehicle in an emergency. For example, depending on the time of year, people trapped in the vehicle can be exposed to very high or very low temperatures.
- Heat build-up in the passenger and luggage compartment of a parked vehicle can result in temperatures in the vehicle that are much higher than the outside temperatures, particularly in summer. Temperatures can quickly reach levels that can cause unconsciousness and death, particularly to small children.

 In vehicles with a diesel engine and Keyless Access, the engine start may be delayed if the engine has to be preheated.

 If the ignition is switched on or the engine is running and the driver door is opened, a chime sounds. The chime is also a reminder to switch off the engine and turn off the ignition before leaving and locking the vehicle from the outside.

## Starting the engine

---

 Please first read and note the introductory information and heed the WARNINGS 

Please perform these steps only in the order listed.

Step	Vehicles without Keyless Access	Vehicles with Keyless Access
1.	Depress and hold down the brake pedal until step 4 is completed.	
2.	Shift the transmission into Park (P) or (N).	
3.	<p>Turn the remote control vehicle key <i>briefly</i> clockwise or counterclockwise ⇒ <a href="#">fig. 246 (2)</a> and release.</p> <p><b>In vehicles with a diesel engine</b>, the engine start may be delayed if the engine is preheated.</p>	<p>Press the starter button ⇒ <a href="#">fig. 247</a> <i>briefly</i> and release - do not depress the accelerator pedal. An authorized remote control vehicle key must be inside the vehicle in order to start the engine.</p> <p><b>In vehicles with a diesel engine</b>, the engine start may be delayed if the engine is preheated.</p>
4.	If the engine does not start, switch off the ignition and start again after about 1 minute.	
5.	Release the electronic parking brake when you are ready to start driving	

 **WARNING**

Never leave the vehicle unattended while the engine is running. The vehicle could move suddenly, especially when the vehicle is in gear, resulting in accidents and personal injury.

 **WARNING**

“Starting fluids” can explode and can cause a “run-away” vehicle condition.

- Never use starting assist fluids.

 **NOTICE**

- You can damage the starter or the engine if you try to start the engine when the vehicle is still moving, or if you try to restart the engine right after switching it off.

- Avoid high engine speeds, full throttle acceleration and heavy engine loads when the engine is cold.
- Do not try to start the engine by pushing or towing the vehicle. Unburned fuel can get into the catalytic converter and damage it. The steering column may also be locked.



Do not let your vehicle warm up while standing; instead, start driving right away after making sure that you have good visibility through all windows. This will help the engine reach operating temperature faster and keep down emissions.



If the battery in the remote control vehicle key is weak or dead, the engine cannot be started with the starter button. In this case, remove the starter button from the ignition switch and insert the remote control vehicle key into the ignition switch to start the vehicle.



Major consumers of electricity are temporarily switched off when the engine is being started.



After starting a cold engine, there may be increased operating noises for a few seconds. This is normal and harmless.

## Stopping the engine

Please first read and note the introductory information and heed the WARNINGS

**Please perform these steps only in the order listed.**

	<b>Vehicles without Keyless Access</b>	<b>Vehicles with Keyless Access</b>
1.	Bring the vehicle to a complete stop ⇒ .	
2.	Depress and hold down the brake pedal until step 4 is completed.	
3.	Shift the transmission into Park <b>(P)</b> .	
4.	Apply the electronic parking brake to help prevent the vehicle from moving	
5.	Turn the vehicle key in the ignition clockwise or counterclockwise pause and then release.	Push the starter button to his second position.

Please perform these steps only in the order listed.

	Vehicles without Keyless Access	Vehicles with Keyless Access
6.	Removing the vehicle key from the ignition switches off electrical equipment and activates the steering column lock.	Opening the doors switches off electrical equipment and activates the steering column lock.

**Emergency shut-off function**

If the engine does **not** switch off when the vehicle key is turned in the ignition lock or when the starter button is pressed briefly, it must be switched off using the emergency switch-off function.

The steps should only be carried out in the specified order.

	Vehicles without Keyless Access	Vehicles with Keyless Access
1a.	<p>Selector lever in position <b>D/S/R</b>: turn the vehicle key clockwise or counterclockwise in the ignition lock <i>twice</i> within 1 second and then release the key.</p> <p><b>OR</b>: Hold the vehicle key in the required position for longer than <i>2 seconds</i>.</p>	<p>Selector lever in position <b>D/S/R</b>: at a speed below 10 km/h (6 mph) and with the brake pedal depressed, press the starter button <i>twice</i> within a 1 second period and then release ⇒ ⚠.</p> <p><b>OR</b>: Press and hold the starter button for longer than <i>2 seconds</i>.</p>
1b.	<p>Selector lever in position <b>N</b>: Turn the vehicle key in the ignition lock clockwise or counterclockwise and then let go of the key.</p>	<p>Selector lever in position <b>N</b>: Irrespective of the speed at which the vehicle is travelling, press the starter button <i>once</i> ⇒ ⚠.</p>
2.	The engine switches itself off.	

## WARNING

Never stop the engine before the vehicle has come to a complete stop. You can lose control of the vehicle, crash, and be seriously injured.

- The airbags and safety belt pretensioners will not work when the ignition is switched off.
- The brake booster does not work when the engine is not running. More brake pedal pressure will be needed to stop the vehicle.
- The power steering system does not work when the engine is not running, and you will need more force to steer the vehicle.
- When the key is removed from the ignition switch, the steering will lock and you will not be able to steer the vehicle.

## NOTICE

If the vehicle has been driven hard for a long time, the engine could overheat when it is stopped. To reduce the risk of engine damage, let the engine idle in Neutral for about 2 minutes before you switch off the ignition.

 If the ignition is switched on or the engine is running and the driver door is opened, a chime sounds. The chime is also a reminder to switch off the engine and turn off the ignition before leaving and locking the vehicle from the outside.

 The vehicle key can be removed from the ignition only when the transmission is in Park (P).

 After the engine has been switched off, the radiator fan in the engine compartment may keep running for several minutes, or may start running after the vehicle has been parked for a while, even if the ignition is switched off and the vehicle key has been removed. The radiator fan shuts off automatically when the engine has cooled down enough.

## Electronic immobilizer

 Please first read and note the introductory information and heed the WARNINGS 

The immobilizer helps to prevent the engine from being started and driven with an unauthorized vehicle key.

There is a microchip inside the vehicle key. The chip deactivates the immobilizer automatically when an authorized vehicle key is inserted into the ignition switch.

The electronic immobilizer is automatically activated when the remote control vehicle key is pulled out of the ignition switch. On vehicles with Keyless Access, the remote control vehicle key must be outside the vehicle ⇒ *Unlocking or locking vehicles with Keyless Access.*

The engine can therefore only be started with an authorized and correctly coded genuine Volkswagen remote control vehicle key. Coded remote control vehicle keys are available from authorized Volkswagen dealers, authorized Volkswagen Service Facilities, and from certain independent repair facilities and locksmiths who are qualified to make these vehicle keys ⇒ *Vehicle key set.*

If an unauthorized remote control vehicle key is used, **Immobilizer active!** appears in the instrument cluster display. The vehicle cannot be operated with this key.

A Declaration of Compliance with the United States FCC and Industry Canada regulations is on.



Using genuine Volkswagen keys helps minimize the risk of malfunctions.



# Shifting

## Introduction

---

In this section you'll find information about:

Warning and indicator lights

Pedals

Automatic transmission: Selector lever

Shifting with Tiptronic®

Driving with automatic transmission

Automatic transmission malfunction

### **When the ignition is switched on and the transmission is in Reverse (R):**

- The backup lights come on.
- The rear window wiper switches on when the windshield wipers are switched on.
- Parking Distance Control, the optical Park Assist system, and the camera for Rear Assist switch on (if applicable).

### **More information:**

- Instruments
- Braking and parking
- Reverse driving assistant (Rear Assist)
- Park distance control system
- Climate control
- Engine control and emission control system
- Emergency closing and opening

### **WARNING**

**Rapid acceleration can cause skidding and loss of traction, especially on slippery roads, resulting in a loss of vehicle control, collisions, and serious personal injury.**

- **Only use the kick-down feature or fast acceleration if visibility, weather, road, and traffic conditions permit it and other drivers will not be endangered by your driving and the vehicle's acceleration.**

### **WARNING**

**Constant braking causes the brakes to overheat and even to fail leading to collisions and serious personal injury.**



- **Never "ride" the brakes or apply the brake pedal too often or too long.**
- **Riding the brakes will substantially reduce braking performance, increase stopping distance, and can cause complete brake system failure.**

 **NOTICE**

- Never “ride” the brakes by keeping your foot on the brake pedal when you do not want to brake. This will make the brakes wear faster.
- Before driving downhill, especially on hills that are long or steep, always reduce speed and shift into lower gear (manual or automatic transmission). This will let the vehicle use engine braking and reduce the load on the brakes. Otherwise, the brake system could overheat and even fail. Only use the brakes when you need them to slow the vehicle down more or to stop.

### Warning and indicator lights

 Please first read and note the introductory information and heed the WARNINGS 

Lights up	Possible cause	Proper response
	Depress brake pedal!	Depress the brake pedal.
	Automatic transmission malfunction.	Have the system checked immediately by an authorized Volkswagen dealer, an authorized Volkswagen Service Facility, or another qualified workshop.
	Depress brake pedal!	Depress the brake pedal to select a gear or drive position.  Also refer to electronic parking brake

Flashes	Possible cause	Proper response
	The release button in the selector lever is not engaged. Vehicle movement is prevented.	Engage selector lever release button

When the ignition is switched on, several warning and indicator lights come on briefly for a function check. They go out after a few seconds.

## **⚠ WARNING**

Failure to heed warning lights and instrument cluster text messages can cause the vehicle to break down in traffic and result in a collision and serious personal injury.

- Never ignore warning lights or text WARNINGS.
- Always stop the vehicle as soon as it is safe to do so.
- Whenever stalled or stopped for repair, move the vehicle a safe distance off the road, turn on the emergency flashers, stop the engine, and use other warning devices to warn approaching traffic.

## **ⓘ NOTICE**

Failure to heed warning lights or text WARNINGS can result in vehicle damage.

## Pedals

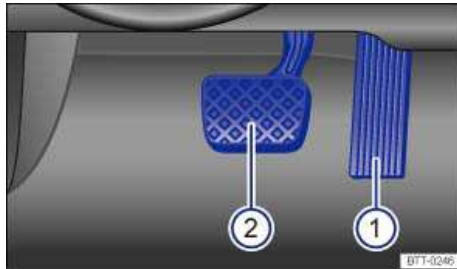

Fig. 248 Pedals in vehicles with automatic transmission: 1 Accelerator pedal, 2 brake pedal.

**ⓘ Please first read and note the introductory information and heed the WARNINGS ⚠**

All pedals must always be able to move freely in and out without interference from floor mats or other things.

Only use floor mats that leave the pedal area free and are held securely in place with floor mat fasteners to help prevent sliding.

If a brake circuit malfunctions, more brake pedal travel is needed to bring the vehicle to a full stop, and it is important that nothing is in the way when you have to depress the brake pedal harder and further than normal.

## **⚠ WARNING**

Objects in the driver footwell can prevent the pedals from moving freely. This can cause loss of vehicle control and increase the risk of serious personal injuries.

- Always make sure that nothing can interfere with the pedals.
- Always fasten floor mats securely to the floor.
- Never put floor mats or other floor coverings on top of already installed floor mats.
- Always make sure that nothing can fall into the driver footwell while the vehicle is moving.

**NOTICE**

Always make sure that the pedals are able to move freely and that nothing can interfere with them. If a hydraulic brake circuit fails, more brake pedal travel will be needed to bring the vehicle to a stop. The brake pedal must be pressed farther and harder than normal.

**Automatic transmission: Selector lever**



Fig. 249 Automatic transmission selector lever with shift lever release button (arrow).

**⚠ Please first read and note the introductory information and heed the WARNINGS ⚠**

Automatic transmission vehicles have an Automatic Shift Lock (ASL). With ASL, you must depress the brake pedal and hold it down while pressing the release button on the selector lever handle in the direction of the arrow ⇒ fig. 249 in order to move the selector lever out of Park (P) and into a drive gear. When the selector lever is in Neutral (N), you also have to depress the brake pedal before you can move the selector lever to Drive (D), Sport Drive (S), or Reverse (R).

If the ignition is switched on, either the current selector lever setting or the current gear is shown in the instrument cluster display.

Selector lever position	Designation	Meaning ⇒ ⚠
P	Park	The drive wheels are mechanically locked. Select only when the vehicle is <i>not moving</i> . To change the selector lever position, switch on the ignition (if it is off) and then press the release button while holding down the brake pedal.

Selector lever position	Designation	Meaning ⇒ ⚠
<b>R</b>	<b>Reverse</b>	The reverse gear is engaged. Shift into Reverse only when the vehicle is <i>not moving</i> .
<b>N</b>	<b>Neutral</b>	Transmission is in Neutral position. No power is transferred to the wheels and no engine braking effect is available.
<b>D</b>	<b>Drive</b> (Standard driving position)	All forward gears shift up and down automatically. The transmission shifts as needed depending on engine load, individual driving style, and driving speed.
<b>S</b>	<b>Sport Drive</b> (Sport driving position)	All forward gears automatically upshift <i>later</i> and downshift <i>earlier</i> than in the Drive ( <b>D</b> ) position, to take full advantage of the engine's power reserves. The transmission shifts as needed depending on engine load, individual driving style, and driving speed.
▽	<b>Toggle between driving positions</b>	To toggle between Drive ( <b>D</b> ) and Sport Drive ( <b>S</b> ) briefly push the selector lever backward once from the ( <b>D/S</b> ) position. The selector lever always springs back to ( <b>D/S</b> ).  This feature lets you access Tiptronic mode from both the Sport driving position ( <b>S</b> ) and the standard driving position ( <b>D</b> )

#### Automatic Shift Lock (ASL)

The Automatic Shift Lock (ASL) in Park (**P**) and Neutral (**N**) prevents drive positions from being engaged inadvertently, which would cause the vehicle to move.

To release the ASL, depress and hold the brake pedal with the ignition switched on. Press the release button on the selector lever at the same time.

The ASL is not engaged if the selector lever is moved quickly through Neutral (**N**) (e.g., when shifting from Reverse (**R**) to Drive (**D**)). This makes it possible to “rock” the vehicle backwards and forwards if it is stuck in snow or mud. The ASL engages automatically if the brake pedal is not depressed and the lever is in Neutral (**N**) for more than about 1 second and the vehicle is traveling no faster than about 3 mph (5 km/h).



### WARNING

Moving the selector lever to the wrong position can cause loss of vehicle control, a collision, and serious personal injury.

- Never accelerate when moving the selector lever.
- When the engine is running and a drive position is engaged, the vehicle will start to move as soon as the brake pedal is released.
- Never shift into Reverse or Park when the vehicle is moving.



### WARNING

Unintended vehicle movement can cause serious personal injury.

- Never get out of the driver's seat while the engine is running, especially when the transmission is in a drive gear. If you must leave your vehicle while the engine is running, always set the electronic parking brake and shift the transmission into Park (P).
- Never leave the vehicle in Neutral (N). It will roll down hills, whether the engine is running or not.
- When the engine is running and a drive gear - Drive (D), Sport Drive (S), or Reverse (R) - has been selected, press and hold the brake pedal to keep the vehicle from moving. The vehicle may "creep" and move forward or backward even if the engine is idling slowly.
- Never shift into Reverse (R) or Park (P) when the vehicle is moving.



### NOTICE

Even though the transmission is in Park (P), the vehicle may move a couple of inches (a few centimeters) forwards or backwards if you take your foot off the brake pedal after stopping the vehicle without first setting the electronic parking brake.



If the selector lever is moved into Neutral (N) by mistake when the vehicle is moving, take your foot off the accelerator pedal. Wait until the engine speed has dropped to idle speed before moving the selector lever into a drive gear.



Leaving the selector lever for a long period of time in any position other than Park (P) when the ignition is switched off can drain the vehicle battery.

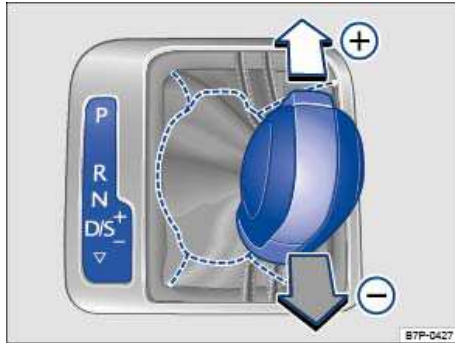

Fig. 250 Selector lever in Tiptronic position.



Fig. 251 Steering wheel with optional Tiptronic shift paddles.

⚠ Please first read and note the introductory information and heed the WARNINGS ⚠

Tiptronic lets you upshift and downshift manually with the automatic transmission. When Tiptronic mode is used, the transmission stays in the current gear and does not upshift or downshift automatically unless the transmission senses a situation where upshifting or downshifting is necessary to keep the engine from over- or under-revving.

### Using Tiptronic with the selector lever

- Push the selector lever sideways to the right from Drive **D/S** position into the Tiptronic position ⇒ ⚠ in *Automatic transmission: Selector lever*
- Briefly push the selector lever forward (+) to upshift into a higher gear or backward (-) to downshift into a lower gear ⇒ fig. 250.

### Using Tiptronic with the shift paddles behind the steering wheel

- The paddles ⇒ fig. 251 (arrows) work when the selector lever is in the Tiptronic position or when the selector lever is in Drive (**D**) or Sport Drive (**S**). You do not have to move the selector lever over to the right into the Tiptronic position.
- To upshift, pull the paddle on the right **+ OFF** toward you.
- To downshift, pull the paddle on the left **-** toward you.

- To switch off Tiptronic mode, pull the paddle on the right **+ OFF** toward you and hold it there for about 1 second.

Tiptronic will switch off automatically if the shift paddles have not been used for a while and the selector lever is not in the Tiptronic position.

## NOTICE

- **During acceleration, the transmission will shift automatically into the next higher gear before reaching maximum engine speed (rpm).**
- **If you use Tiptronic to shift into a lower gear, the transmission will downshift only when doing so will not over-rev the engine.**

## Driving with automatic transmission

---

 **Please first read and note the introductory information and heed the WARNINGS **

All forward gears shift up and down automatically.

### Driving on hills

The steeper the grade, the lower the gear that must be selected. Lower gears increase the braking effect of the engine. Never coast downhill in Neutral (N).

- Reduce speed.
- Switch to Tiptronic mode by moving the selector lever from Drive (D) to the right into the Tiptronic position ⇒ *Shifting with Tiptronic®*.
- Downshift by pulling the selector lever back briefly (-).
- **OR:** Downshift using the paddles (if equipped) on the steering wheel.

### Stopping and starting on hills

If you stop on a hill with the vehicle in gear, you must depress the brake pedal or engage the electronic parking brake to keep the vehicle from rolling. Do not release the brake pedal or the parking brake until the vehicle has started to move forwards ⇒ .

### Kick-down acceleration

The kick-down feature permits maximum acceleration when the selector lever is in the Drive (D), Sport Drive (S) or Tiptronic mode.

If you push the accelerator all the way down, the vehicle will automatically downshift, depending on vehicle speed and engine speed (rpm). This feature lets you take advantage of the full acceleration capacity of the vehicle ⇒ .

With kick-down actuated, the transmission will stay in the current gear longer and not upshift until the engine reaches maximum rpm.



## WARNING

Rapid acceleration can cause skidding and loss of traction, especially on slippery roads, resulting in a loss of vehicle control, collisions, and serious personal injury.

- Only use the kick-down feature or fast acceleration if visibility, weather, road, and traffic conditions permit and other drivers will not be endangered by your driving and the vehicle's acceleration.
- Always adapt your driving to the traffic flow.
- Note that the drive wheels can spin and the vehicle can swerve when ASR is switched off, especially when the road is slippery.
- Once you have accelerated, switch ASR back on again.

## NOTICE



- When stopping on hills with the transmission in a drive gear, do not use the accelerator to help prevent the vehicle from rolling backwards. This can cause the automatic transmission to overheat and be damaged.
- Never let the vehicle coast or roll down a hill in Neutral (N), especially when the engine is not running. The transmission will not be lubricated and will be damaged.

## Automatic transmission malfunction

---

 Please first read and note the introductory information and heed the WARNINGS 

### Emergency shift program

If the automatic gearbox goes to emergency program, it is indicated with a text message along with a yellow indicator lamp  on the instrument cluster display. Depending on the current system fault, the selector lever position may continue to be displayed. The text message will go away after a few seconds. The yellow indicator lamp  remains lit up while the system fault continues to exist.

In any event, have the automatic transmission checked by an authorized Volkswagen dealer or authorized Volkswagen Service Facility.

## NOTICE

- As soon as you get any of these warnings about transmission overheating, you must either park the vehicle in a safe place or drive faster than 12 mph (20 km/h).
- If the text message and acoustic warning repeat themselves every 10 seconds or so, you must park the vehicle in a safe place as soon as you can safely do so and stop the engine. Let the transmission cool down.
- To help prevent damage to the transmission, do not drive the vehicle again until the acoustic warning has stopped. As long as the engine is overheated, avoid stop and start driving and avoid low speeds (“walking pace”).

# Braking and parking

## Introduction

---

In this section you'll find information about:

Warning and indicator lights  
Electronic parking brake  
Parking  
About the brakes  
Braking assistance systems  
Switching Anti-Slip Regulation (ASR) on and off  
Brake fluid

The **braking assistance systems** are the Anti-Lock Brake System (ABS), Brake Assist System (BAS), Electronic Differential Lock (EDL), Anti-Slip Regulation (ASR) and Electronic Stability Control (ESC).

### More information:

- Trailer towing
- Tires and wheels
- Starting assistance systems
- Parts, accessories, repairs and modifications



### WARNING

Driving with bad brakes or worn brake pads can cause a collision and serious personal injury.

- If the symbol **BRAKE WEAR** or  lights up in the instrument cluster display, whether alone or together with a text message, immediately contact an authorized Volkswagen dealer or authorized Volkswagen Service Facility to have the brake pads checked and, if necessary, replaced.

**⚠ WARNING**

Parking improperly can cause serious personal injury.

- Never remove the key from the ignition switch while the vehicle is moving or rolling to a stop. The steering wheel will lock and you will not be able to steer or control the vehicle.
- Never park the vehicle where the hot exhaust system or catalytic converter could ignite flammable materials, such as brush, leaves, dry grass, spilled fuel, etc.
- Always apply the parking brake when parking your vehicle.
- Improper use of the parking brake can seriously injure you and your passengers.
- Never use the parking brake to slow down the vehicle when it is moving, except in an emergency. The stopping distance is much longer because only the rear wheels are braked. Always use the foot brake to stop the vehicle.
- Never activate the throttle manually from the engine compartment when the engine is running and the automatic transmission is in gear. The vehicle will start to move as soon as the engine speed increases even if the parking brake is on.
- Never leave children or anyone who cannot help themselves behind in the vehicle. They could release the parking brake and move the gear selector lever or gear shift, which could cause the vehicle to start moving. This can lead to a crash and serious personal injuries.
- Always take the key with you when you leave the vehicle. The engine can be started and vehicle systems such as the power windows can be operated, leading to serious personal injury.
- Never leave children, disabled persons, or anyone who cannot help themselves in the vehicle. The doors can be locked with the remote control vehicle key, trapping passengers in the vehicle in an emergency. For example, depending on the time of year, people trapped in the vehicle can be exposed to very high or very low temperatures.
- Heat buildup in the passenger and luggage compartment of a parked vehicle can result in temperatures in the vehicle that are much higher than the outside temperatures, particularly in summer. Temperatures can quickly reach levels that can cause unconsciousness and death, particularly to small children.











**! NOTICE**









- Always be careful when you park in areas with parking barriers or high curbs. These vary in height and could damage your bumper and related parts if the front of your vehicle hits a barrier or curb that is too high while you are getting into or out of a parking spot. To help prevent damage, stop before the tires of your vehicle touch a parking barrier or curb.
- Always be careful when you enter a driveway or drive up or down steep ramps or over curbs or other obstacles. Parts of the vehicle close to the ground may be damaged (such as bumper covers, spoilers, and parts of the engine, suspension, and exhaust systems).





**Warning and indicator lights**

☞ Please first read and note the introductory information and heed the WARNINGS ⚠

Lights	Possible cause or meaning	Proper response
up	⇒ ⚠	

Lights up	Possible cause or meaning ⇒ ⚠	Proper response
	 <b>Stop!</b> Electronic parking brake engaged.	In order to drive off, release the electronic parking brake by depressing the brake pedal
	Brake system malfunction.	 <b>Stop!</b> Get professional assistance immediately
	Brake fluid level too low.	 <b>Stop!</b> Check the brake fluid level
	Together with ABS indicator light  or <b>ABS</b> : ABS failure.	See an authorized Volkswagen dealer or an authorized Volkswagen Service Facility. The vehicle brakes will work without ABS.
	Together with indicator light  : electronic parking brake malfunction.	See an authorized Volkswagen dealer or authorized Volkswagen Service Facility because you may not be able to park the vehicle safely.
	Depress brake pedal!	Depress the brake pedal.
	Brake pads worn.	If you believe it is safe to do so, immediately take the vehicle to an authorized Volkswagen dealer or authorized Volkswagen Service Facility. Check, and if necessary replace, <b>all</b> brake pads.
	Electronic parking brake malfunction.	See an authorized Volkswagen dealer or authorized Volkswagen Service Facility because you may not be able to park the vehicle safely.

Lights up	Possible cause or meaning ⇒ 	Proper response
	ESC malfunction.	Take the vehicle to an a qualified workshop.
	ESC switched off by the system.	Switch ignition off and on again. You may have to drive a short distance.
	Together with ABS indicator light  or <b>ABS</b> : ABS malfunction.	Take the vehicle to an a qualified workshop. The vehicle brakes will work without ABS.
	Vehicle battery has been re-connected.	Drive a short distance at a speed of 10 – 12 mph (15 - 20 km/h. If the indicator light stays on, see an authorized Volkswagen dealer or an authorized Volkswagen Service Facility
	Deactivation of ESC (by the system).	Switch ignition off and on again. You may have to drive a short distance.
	Deactivation of ASR (manually).	Switch on ASR manually. Automatically switch on ASR by turning the ignition on and off.
 / <b>ABS</b>	Together with ESC indicator light  : ABS malfunction.	See an authorized Volkswagen dealer or an authorized Volkswagen Service Facility. The vehicle brakes will work without ABS.
	Together with warning light  or <b>BRAKE</b> : ABS failure.	
	Depress brake pedal!	Depress the brake pedal to select a gear or drive position.
		Depress the brake pedal to release electronic parking brake.

Flashes	Possible cause	Proper response
 / <b>PARK</b>	Electronic parking brake malfunction.	 <b>Do not continue driving</b> Contact an authorized Volkswagen dealer or authorized Volkswagen Service Facility for assistance.
	ESC or ASR is working.	Take foot off accelerator pedal. Adapt driving to road conditions.
	The release button in the selector lever is not engaged.	Engage the Automatic Shift Lock (ASL).

When the ignition is switched on, several warning and indicator lights come on briefly for a function check. They go out after a few seconds.





### **WARNING**

Failure to heed warning lights and instrument cluster text messages can cause the vehicle to break down in traffic and result in a collision and serious personal injury.

- Never ignore warning lights or text WARNINGS.
- Always stop the vehicle as soon as it is safe to do so.

### **WARNING**

Driving with bad brakes can cause a collision and serious personal injury.

- If the brake warning light **BRAKE** or  does not go out, or comes on when driving, either the brake fluid level in the reservoir is too low or there is a fault in the brake system. Stop the vehicle as soon as you can do so safely and get expert assistance ⇒ page 423, *Brake fluid*.
- If the brake warning light **BRAKE** or  comes on at the same time as the ABS warning light **ABS** or , the ABS may not be working properly. This could cause the rear wheels to lock up relatively quickly during braking. Rear wheel brake lock-up can cause loss of vehicle control.
- If you believe the vehicle is safe to drive, drive slowly and very carefully to the nearest authorized Volkswagen dealer, authorized Volkswagen Service Facility, or other qualified workshop and have the brake system inspected. Avoid sudden hard braking and steering.
- If the ABS indicator light **ABS** or  does not go out, or if it comes on while driving, the ABS system is not working properly. The vehicle can then be stopped only with the standard brakes (without ABS). You will not have the protection ABS provides. Contact your authorized Volkswagen dealer or an authorized Volkswagen Service Facility as soon as possible.
- If the symbol **BRAKE WEAR** or  lights up in the instrument cluster display, whether alone or together with a text message, immediately contact an authorized Volkswagen dealer or authorized Volkswagen Service Facility to have the brake pads checked and, if necessary, replaced.

## ! NOTICE

Failure to heed warning lights or text WARNINGS can result in vehicle damage.

### Electronic parking brake

---



Fig. 252 In the lower front center console: Switch for the electronic parking brake.

ⓘ Please first read and note the introductory information and heed the WARNINGS ⚠

#### Setting the electronic parking brake

You can engage the electronic parking brake any time the vehicle is not moving - even if the ignition is switched off. Always engage the parking brake when you leave or park the vehicle.

- Pull and hold the switch ⇒ fig. 252.
- The parking brake is engaged when the indicator light (P) in the switch and in the instrument cluster ⇒ *Braking and parking* comes on.

#### Releasing the electronic parking brake

- Switch the ignition on.
- Press the switch ⇒ fig. 252. At the same time, press the brake pedal firmly or press the accelerator pedal lightly if the engine is running.
- The parking brake is released when the indicator light (P) in the instrument cluster goes out.

#### Releasing the electronic parking brake automatically when you start driving

The electronic parking brake releases automatically when you start driving if the driver's door is closed **and** the driver's safety belt is buckled.

#### Emergency braking function

Only use the emergency braking function in an emergency, when you cannot stop the vehicle using the brake pedal ⇒ ⚠ !

- Pull and hold the switch ⇒ fig. 252 to brake the vehicle **hard**. An audio warning signal will sound at the same time.
- To stop the braking maneuver, release the switch or press the accelerator pedal.



## WARNING

Improper use of the electronic parking brake can cause accidents and severe injuries.

- Never use the parking brake to slow down the vehicle when it is moving, except in an emergency. Braking distance is much longer, since only the rear wheels are braked. Always use the foot brake.
- Never press the accelerator pedal when a selector lever position or gear is engaged and the engine is running. The vehicle could begin moving, even if the electronic parking brake is set.
- Never activate the throttle manually from the engine compartment when the engine is running and the automatic transmission is in gear. The vehicle will start to move even if the parking brake is engaged.



## NOTICE

Even though the transmission is in Park (P), the vehicle may move a couple of inches (a few centimeters) forwards or backwards if you take your foot off the brake pedal after stopping the vehicle without first firmly setting the parking brake.



If the vehicle battery is dead, the electronic parking brake cannot be released. Use a jump-start



You may hear noises when setting or releasing the electronic parking brake.



If the electronic parking brake is not used for a while, an automatic system check will occasionally run when the vehicle is parked. This system check makes audible noises.

## Parking

---

 Please first read and note the introductory information and heed the WARNINGS 

Please note legal regulations when stopping and parking your vehicle.

### Parking the vehicle

Please perform these steps only in the order listed.

- Stop the vehicle on a suitable surface ⇒ .
- Hold the brake pedal down until the engine is switched off.
- Apply the electronic parking brake to help prevent the vehicle from moving ⇒ *Electronic parking brake*.
- Shift the transmission into Park (P).
- Switch off the engine and then take your foot off the brake.
- Remove the vehicle key from the ignition.
- If necessary, turn the steering wheel slightly to engage the steering lock.
- Make sure all passengers and especially children leave the vehicle.
- Take all vehicle keys with you when leaving your vehicle.
- Lock the vehicle.



## On hills

Before stopping the engine, turn the steering wheel so that, if the vehicle starts to roll, its front wheels will roll into the curb:

- Facing downhill, turn the front wheels so that they point toward the curb.
- Facing uphill, turn the front wheels so that they point away from the curb.

### WARNING

The vehicle exhaust system and the catalytic converter or diesel particulate filter get very hot. They can cause fires and serious personal injury.

- Never park where the hot exhaust system could ignite flammable materials, such as brush, leaves, dry grass, spilled fuel, etc.

### NOTICE

- Always be careful when you park in areas with parking barriers or high curbs. These vary in height and could damage your bumper and related parts if the front of your vehicle hits a barrier or curb that is too high while you are getting into or out of a parking spot. To help prevent damage, stop before the tires of your vehicle touch a parking barrier or curb.
- Always be careful when you enter a driveway or drive up or down steep ramps or over curbs or other obstacles. Parts of the vehicle close to the ground may be damaged (such as bumper covers, spoilers, and parts of the engine, suspension, and exhaust systems).

## About the brakes

 Please first read and note the introductory information and heed the WARNINGS 

**New brake pads** do not provide full performance during the first 100 to 200 miles (200 to 300 km) and must first be “broken” in ⇒ . To some extent, you can make up for the somewhat reduced performance by applying more pressure to the brake pedal. But, **during the break-in period**, the stopping distance for hard braking and emergency braking will be longer until the brakes are fully broken in. Avoid hard braking and situations that might require hard braking (such as following other vehicles too closely) – especially during the break-in period.

**Brake pad wear** depends mostly on operating conditions and the way the vehicle is driven. If you do a lot of city and short-distance driving and/or have a sporty driving style, you should have the brake pads checked by an authorized Volkswagen dealer or authorized Volkswagen Service Facility more often than the regular service intervals.

**Wet brakes** (for example, after driving through water or washing the vehicle or after heavy rainfall) will not brake as well. Stopping distances will be longer when brake discs are wet or, in winter, even icy. Wet or icy brakes must be dried as soon as possible by carefully applying the brakes a couple of times while traveling at a relatively high speed. Make sure nobody is behind you and that you do not endanger yourself or others ⇒ .

**Brakes coated with road salt** also react slower and need longer stopping distances. If there is salt on the roads and you are not braking regularly, brake carefully and gently from time to time to remove any salt coating from the brake discs and pads ⇒ .

Brake disc **corrosion** (rust) and **dirt** build-up on the brake pads are more likely to occur if the vehicle is not driven much or is driven only for short distances with little braking. If the brakes have not been used and there is some rust on the discs, clean the brake discs and pads once in a while by carefully braking a couple of times while driving at relatively high speed to help clean the brake discs and pads.

Make sure nobody is behind you and that you do not endanger yourself or others ⇒ .

### Brake system malfunction

If you brake and find that vehicle doesn't brake nearly as well as it used to (sudden increase in stopping distance), a brake circuit may have failed. The brake warning light **BRAKE** or  will come on and a message may appear in the instrument cluster display. If you believe the vehicle is safe to drive, immediately take it to the nearest authorized Volkswagen dealer or authorized Volkswagen Service Facility for repair. Drive slowly and very carefully, allow for the longer stopping distance, and be ready to push longer and harder on the brake pedal to slow the vehicle down.

### Brake booster

The brake booster works only when the engine is running. It increases the force on the brakes above and beyond the pressure put on the brake pedal by the driver.

If the brake booster is not working, or if the vehicle has to be towed, you will have to push the brake pedal harder to make up for the lack of booster assistance and the resulting longer stopping distance  
⇒ .

#### **WARNING**

New brake pads do not provide maximum braking performance.

- New brake pads do not have the best stopping power for the first 200 miles (320 km) and must be "broken in." You can compensate for the slightly reduced braking force by putting more pressure on the brake pedal.
- Drive with extra care while the new brake pads are being broken in. This reduces the risk of collisions and serious personal injuries due to a loss of control over the vehicle.
- Never follow other vehicles too closely or put yourself into other situations that might require sudden, hard braking, especially when the brake pads have not been broken in.

#### **WARNING**

Overheated brakes will reduce the vehicle's stopping power and increase stopping distances considerably.

- When driving downhill, the brakes have to work especially hard and heat up quickly.
- Before driving downhill, especially on hills that are long or steep, always reduce speed and shift into lower gear (manual or automatic transmission). This will let the vehicle use engine braking and reduce the load on the brakes. Otherwise, the brake system could overheat and possibly fail. Only use the brakes when you need them to slow the vehicle down more or to stop.
- A damaged front spoiler or a non-standard spoiler can reduce airflow to the brakes and make them overheat.

#### **WARNING**

Wet brakes or brakes coated with ice or road salt react slower and need longer stopping distances.

- Carefully apply the brakes to test them.
- Always dry brakes and clean off ice and salt coatings with a few cautious brake applications when visibility, weather, road and traffic conditions permit.

## WARNING

Driving when the brake booster is not working increases stopping distances and can cause accidents and serious personal injuries.

- Never let the vehicle coast when the engine is switched off.
- If the brake booster is not working (such as when the vehicle is being towed), a lot more pedal force is needed to slow down and stop.

## NOTICE

- Never “ride” the brakes by keeping your foot on the brake pedal when you do not want to brake. Constant pressure on the brake pedal can make the brakes overheat. Riding the brakes will substantially reduce braking performance, increase stopping distance, and can cause complete brake system failure.
- Before driving downhill, especially on hills that are long or steep, always reduce speed and shift into lower gear (manual or automatic transmission). This will let the vehicle use engine braking and reduce the load on the brakes. Otherwise, the brake system could overheat and possibly fail. Only use the brakes when you need them to slow the vehicle down more or to stop.



When the front brakes are serviced, you should have the rear brake pads inspected at the same time. The wear of all brake pads should be visually checked regularly. The best way to check for brake pad wear is to have your authorized Volkswagen dealer or authorized Volkswagen Service Facility visually inspect the pads through the openings in the wheel rims or from underneath the vehicle. If necessary, the wheels can be taken off for a more thorough inspection.

## Braking assistance systems

---

 Please first read and note the introductory information and heed the WARNINGS 

The ESC, ABS, BAS, ASR and EDL braking assistance systems work only when the engine is running. These systems can significantly improve active driving safety.

### Electronic Stability Control (ESC)

ESC helps to improve road holding and vehicle dynamics to help reduce the probability of skidding and loss of vehicle control. It works only when the engine is running. ESC detects certain difficult driving situations, including when the vehicle is beginning to spin (yaw) out of control. ESC then helps you to get the vehicle back under control by selectively braking the wheels and/or reducing engine power and by providing steering assistance to help hold the vehicle on the driver's intended course.

ESC has limitations. It is important to remember that ESC cannot overcome the laws of physics. It will not always be able to help out under all conditions you may come up against. For example, ESC may not always be able to help you master situations where there is a sudden change in the coefficient of friction of the road surface. When there is a section of dry road that is suddenly covered with water, slush or snow, ESC cannot perform the same way it would on a dry surface. If the vehicle “hydroplanes” (rides on a cushion of water instead of the road surface), ESC will not be able to help you steer the vehicle because contact with the pavement has been interrupted and the vehicle cannot be braked or steered. During fast cornering, particularly on winding roads, ESC cannot always deal as effectively with difficult driving situations as it can at lower speeds. When towing a trailer, ESC is not able to help you regain control as it would if you were not towing a trailer.

Always adjust your speed and driving style to visibility, road, traffic, and weather conditions. ESC cannot override the vehicle's physical limits, increase the available traction, or keep a vehicle on the road if road departure is a result of driver inattention. Instead, ESC improves the possibility of keeping the vehicle under control and on the road during extreme maneuvers by using the driver's steering

inputs to help keep the vehicle going in the intended direction. If you are traveling at a speed that causes you to run off the road before ESC can provide any assistance, you may not experience the benefits of ESC.

ESC includes and/or works together with the ABS, BAS, ASR, EDL, and XDL systems (see below). ESC is switched on all the time. In certain situations when you need less traction or additional traction cannot be achieved, you can switch off ESC by pressing the ASR button ⇒ [fig. 253](#). Be sure to switch ASR on again when you no longer need less traction.

ESC can be switched on and off manually in *Off-road Mode* ⇒ *Off-road mode*.

### **Anti-Lock Brake System (ABS)**

ABS helps to keep the wheels from locking up and helps to maintain the driver's ability to steer and control the vehicle. This means the vehicle is less likely to skid, even during hard braking:

- Push the brake pedal down hard and hold it there. Don't take your foot off the pedal or reduce the force on the pedal!
- Do not "pump" the brake pedal or let up on it!
- Steer the vehicle while pushing down hard on the brake pedal.
- ABS stops working if you release or let up on the brake.

When ABS is doing its job, you will notice a **slight vibration** through the brake pedal and hear a noise. *ABS cannot shorten the stopping distance under all conditions*. The stopping distance may even be longer, for instance, when driving on gravel or on newly fallen snow covering an icy or slippery surface.

When driving forwards on loose surfaces, a special off-road ABS is automatically activated. In this mode, the front wheels could lock briefly. This shortens the braking distance in off-road situations as the wheels dig into loose surfaces. This occurs only when driving straight ahead. When the front wheels are turned, the normal ABS is activated.

### **Brake Assist (BAS)**

The Brake Assist System (BAS) can help to reduce stopping distances. If you press the brake pedal very quickly, BAS detects an emergency situation. It then very quickly builds up full brake system pressure, maximizing braking power and reducing the stopping distance. This way, ABS can be activated more quickly and efficiently.

Do **not** reduce pressure on the brake pedal! BAS switches off automatically as soon as you release or let up on the brake.

### **Anti-Slip Regulation (ASR)**

ASR reduces engine power directed to spinning wheels and adjusts power to the road conditions. Even under poor road conditions, ASR can make it easier to get moving, accelerate, and climb hills.

ESC and ASR can help when driving on loose surfaces (such as gravel) and in deep snow. If you get stuck in deep snow, you may be able to get going again by "rocking" the vehicle back and forth. ESC and ASR recognize this special driving situation and automatically increase the speed of the front wheels. Keep pressing the accelerator and let ESC increase the speed of the front wheels to help you keep moving or get moving again.

ASR can be switched on or off manually ⇒ *Switching Anti-Slip Regulation (ASR) on and off*.

### **Electronic Differential Lock (EDL and XDL)**

EDL is applied during regular straight-line acceleration. EDL gently brakes a drive wheel that has lost traction (spinning) and redirects the drive force to other drive wheels. In extreme cases, EDL automatically switches off to keep the brake from overheating. As soon as the brake has cooled down, EDL automatically switches on again.

XDL is an extension of the Electronic Differential Lock system. XDL does not react to drive wheel slippage when driving straight ahead. Instead, XDL detects slippage of the inside front wheel during

fast cornering. XDL applies enough brake pressure to this wheel in order to stop the slippage. This improves traction, which helps the vehicle stay on track.

### **WARNING**

Driving fast on icy, slippery, or wet roads can lead to a loss of control and result in serious personal injury for you and your passengers.

- Always adjust your speed and driving style to road, traffic, weather, and visibility conditions. Never let the additional safety that ESC, ABS, BAS, ASR, and EDL can provide tempt you into taking extra risks.
- Braking assistance systems cannot overcome the laws of physics and always prevent loss of vehicle control. Slippery and wet roads are still dangerous even with ESC and the other systems!
- Driving too fast on wet roads can cause the wheels to lose contact with the road and “hydroplane.” A vehicle that has lost road contact cannot be braked, steered, or controlled.
- These systems cannot reduce the risk of accident, for example if you drive too fast for conditions or if you do not keep your distance from the vehicle in front of you.
- Although these systems are very effective and can help you control the vehicle in many difficult situations, always remember that your vehicle handling control is limited by tire traction.
- When accelerating on a slippery surface, for example on ice and snow, depress the accelerator carefully. Even with these systems, the wheels may start to spin, leading to a loss of vehicle control.

### **WARNING**

The effectiveness of ESC can be significantly reduced if other components and systems that affect vehicle dynamics, including but not limited to brakes, tires, and other systems mentioned above, are not properly maintained or functioning.

- Always remember that vehicle alterations or modifications can affect the functioning of the ABS, BAS, ASR, EDL, and ESC systems.
- Changing the vehicle suspension or using an unapproved tire / wheel combination can change the way the ABS, BAS, ASR, EDL, ASR, and ESC systems work and reduce their effectiveness.
- The effectiveness of ESC is also determined by the tires fitted ⇒ page 175, *Tires and wheels*.

 All 4 wheels must be equipped with identical tires in order for ESC and ASR to work properly. Differences in the tread circumference of the tires can cause the system to reduce the engine power when it is not expected.

 If ABS is not working, ESC, ASR, and EDL will also not work.

 You may hear noises when these systems are active.

## Switching Anti-Slip Regulation (ASR) on and off

---



Fig. 253 In the front center console: Button to manually switch ASR on and off.

**⚠ Please first read and note the introductory information and heed the WARNINGS ⚠**

The Electronic Stability Control (ESC) only works when the engine is running. This system includes ABS, EDL and ASR.

ASR can be switched off by pressing  button ⇒ [fig. 253](#) while the engine is running. Switch off ASR only in situations where there is not enough traction, such as the following:

- When driving in deep snow or on loose surfaces.
- When “rocking” the vehicle back and forth when you are stuck.

Afterward, reactivate ASR by pressing the  button again.

In *Off-road Mode* you can also switch ESC on or off on some models by pushing the  button ⇒ *Off-road mode*.

## Brake fluid

---



Fig. 254 In engine compartment: Brake fluid reservoir cap.

**⚠ Please first read and note the introductory information and heed the WARNINGS ⚠**

Brake fluid absorbs water from the air over time. Too much water in the brake fluid will damage the brake system. Water also lowers the boiling point of the brake fluid. Too much water in the brake fluid can cause vapor lock during heavy brake use or hard braking. Vapor lock reduces braking perfor-

mance, increases stopping distances and can even cause total brake failure. Your safety and the safety of others depends on brakes that are working properly at all times ⇒ ⚠.

### Brake fluid specifications

Volkswagen has developed a special brake fluid that is optimized for the brake system in your Volkswagen. Volkswagen recommends that you expressly use brake fluid that conforms to quality standard **VW Standard 501 14** for optimum performance of the brake system. Check the information on the container for the brake fluid you want to use to make sure it meets the requirements for your vehicle.

Brake fluid that complies with **VW Standard 501 14** can be purchased from your authorized Volkswagen dealer or authorized Volkswagen Service Facility.

If this special brake fluid is not available you may – under these circumstances – use another high-quality brake fluid that complies with U.S. Federal Motor Vehicle Safety Standard (FMVSS) 116 DOT 4 ⇒ ⚠.

Please note, however, that not all brake fluids that comply with U.S. Federal Motor Vehicle Safety Standard FMVSS 116 DOT 4 have the same chemical composition. Some of these brake fluids can contain chemicals that could, over time, degrade or damage internal parts of the vehicle's brake system.

Volkswagen therefore recommends that you use brake fluid that expressly complies with **VW Standard 501 14** for optimum brake system performance over the long term.

### Brake fluid level

The fluid level in the transparent brake fluid reservoir must always be between the MIN and MAX marking ⇒ ⚠.

On some vehicles, engine components block the view of the brake fluid reservoir and make it impossible to see the brake fluid level. If you cannot clearly see the brake fluid level in the brake fluid reservoir, please see an authorized Volkswagen dealer or authorized Volkswagen Service Facility.

The brake fluid level drops slightly when the vehicle is being used as the brake pads wear and the brakes are automatically adjusted.

### Changing brake fluid

Brake fluid must be changed according to the service schedule in your ⇒ Booklet *Warranty and Maintenance*. Have the brake fluid checked by an authorized Volkswagen dealer or an authorized Volkswagen Service Facility. Refill only with new brake fluid that meets the standards listed above.

## WARNING

**Brake failure and reduced brake performance can be caused by not having enough brake fluid in the reservoir or by old or incorrect brake fluid.**

- Check the brake system and brake fluid level regularly.
- Always change the brake fluid according to the service schedule in your ⇒ Booklet *Warranty and Maintenance*.
- Hard braking with old brake fluid may cause vapor lock. Vapor lock reduces braking performance, increases stopping distances and can even cause total brake failure.
- Always make sure that only the correct brake fluid is used. Only use brake fluid that expressly conforms to VW Standard 501 14 or, if it is not available, only use a high-quality brake fluid that conforms to U.S. Standard FMVSS 116 DOT 4 requirements.
- Using another brake fluid, or one that is not of high quality, can impair the function of the brake system and reduce its effectiveness. If the container does not say that the brake fluid complies with VW Standard 501 14, or U.S. Standard FMVSS 116 DOT 4, do not use it.
- The brake fluid must be new.



## WARNING

Brake fluid is poisonous.

- To reduce the risk of poisoning, never use food, beverage or other non-original containers to store brake fluid. Someone might be misled by the original label on the container, or by the shape of the container, and drink the brake fluid. This could occur even if you relabel the container as “brake fluid.”
- Only store brake fluid in the closed, original container and keep it out of the reach of children.



## NOTICE

Brake fluid will damage vehicle paint, plastic parts and tires. Wipe any brake fluid off vehicle paint and other vehicle parts immediately.



Brake fluid can pollute the environment. Brake fluid that has leaked out must be collected and disposed of properly, following all applicable environmental regulations.



# Saving fuel and helping the environment

## Introduction

---

In this section you'll find information about:

Efficient driving style  
Fuel-efficient driving

Fuel consumption, environmental impact, and wear and tear on engine, brakes and tires depend mainly on the following 3 factors:

- Your personal driving style.
- External driving conditions (weather road conditions).
- Technical requirements.

You can reduce fuel consumption by up to 25% by using a few simple techniques and adjusting your driving style.

### **WARNING**

**Always adjust your speed and the distance you keep between you and the vehicles ahead of you to the road, traffic, weather, and visibility conditions.**



See for additional tips on using your hybrid drive to help reduce fuel consumption.

## Efficient driving style

---

 **Please first read and note the introductory information and heed the WARNINGS **

### Shifting faster

As a rule, the following applies: The higher gear is always the most efficient gear. The rule of thumb for most vehicles is to drive in 3rd gear at about 20 mph / 30 km/h, 4th gear at about 25 mph / 40 km/h, and 5th gear at about 30 mph / 50 km/h.

If traffic and driving conditions permit, "skipping" gears when upshifting also saves fuel.

Do not run the gears up to their limit. Use 1st gear only to start moving and then smoothly shift into 2nd gear. Avoid kick-downs in vehicles with automatic transmissions.

### Coasting

If you take your foot off the accelerator, fuel delivery to the engine is interrupted, which lowers fuel consumption.

Therefore, when nearing a red stop light, for instance, allow the vehicle to coast without using the accelerator. The engine will then continue to run at idle.

In situations where the vehicle will be stopped for a longer period of time, such as at a railroad crossing, physically switch off the engine.

### **Defensive driving and “flowing” with traffic**

Frequent braking and acceleration increases fuel consumption significantly. Just by driving defensively and keeping a sufficiently large distance away from the vehicle in front of you can make up for the speed fluctuations caused by taking your foot off the accelerator. Active braking and accelerating is then not necessarily required.

### **Calm and smooth driving**

Consistency is more important than speed. The more smoothly you drive, the less fuel the vehicle consumes.

When driving on the highway or freeway, a constant, moderate speed is more efficient and economical than constantly accelerating and braking. Usually you can reach your destination just as quickly by driving at a moderate, but steady speed.

The cruise control system can assist in maintaining a uniform driving style.

### **Moderate use of extra electrical loads**

Comfort inside the vehicle is nice and important, but it is important to use them in an environmentally conscious manner.

Some devices can increase fuel consumption when activated (examples):

- Climate control system (air conditioner): If the climate control system has to produce starkly contrasting temperatures, it requires a large amount of energy, which is generated by the engine. The temperature in the vehicle should therefore not be extremely different from that of the outside temperature. It may be helpful to ventilate the vehicle before driving and then to drive a short distance with the windows open. After that, switch on the air conditioner with the windows closed. Keep the windows closed when driving at high speeds. Open windows increase fuel consumption.
- Switch off seat heating once it has served its purpose.
- Switch off the windshield and rear window defroster as soon as the windows are free of fog and ice.

### **Additional factors that increase fuel consumption (examples):**

- Malfunctioning engine control.
- Driving in the mountains.
- Towing a trailer.



### **NOTICE**

**Never let the vehicle coast or roll down a hill in Neutral (N), especially when the engine is not running. The transmission will not be lubricated and will be damaged.**



See additional tips on using your hybrid drive to help reduce fuel consumption.

## Fuel-efficient driving

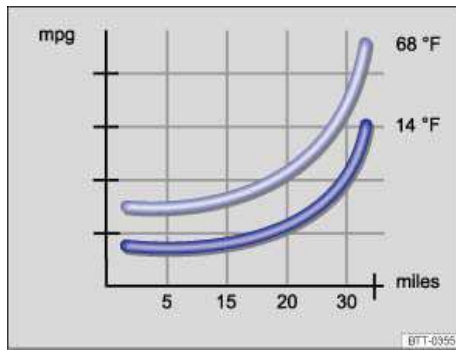

Fig. 255 Fuel consumption at 2 different outside air temperatures.

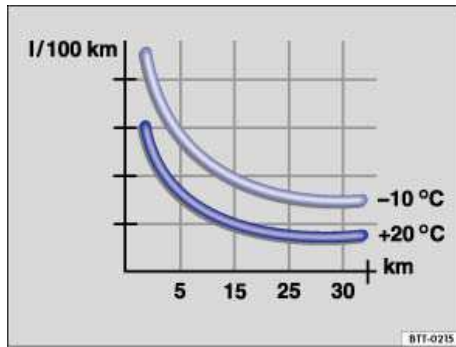

Fig. 256 Fuel consumption in l/100 km at 2 different outside air temperatures.

☐ Please first read and note the introductory information and heed the WARNINGS ⚠

Driving defensively and economically can easily reduce fuel consumption by 10 to 15%.

The vehicle consumes the most fuel when accelerating. Defensive driving requires less braking and therefore less acceleration. If possible, coast the vehicle to a stop, for example, when you can see that the next traffic light is red or is about to turn red.

### Avoid traveling short distances

A cold engine consumes significantly more fuel immediately after starting. It takes a few miles before the engine is warmed up and fuel consumption is stabilized.

To reduce fuel consumption and the emission of pollutants effectively, the engine and catalytic converter must reach their optimal **operating temperature**. Critical in this context is also the **outside air temperature**.

⇒ fig. 255 and ⇒ fig. 256 display the varying fuel consumption rates for the same distance driven, once at +68 °F (+20 °C) and once at +14 °F (-10 °C).

Therefore, avoid driving short distances unnecessarily and consolidate routes.

Under the same conditions, the vehicle consumes more fuel in winter than in summer.

“Letting the engine run to warm up” is not only illegal in some places, but also technically not necessary and wastes fuel.

**Adjust the tire pressure**

The proper tire pressure helps reduce rolling resistance as well as fuel consumption.

When purchasing new tires, always make sure that the tires are optimized for lower rolling resistance.

**Use low viscosity engine oil**

Fully "synthetic," low viscosity engine oils that expressly comply with Volkswagen oil quality standards reduce fuel consumption. Low viscosity engine oils reduce the frictional resistance on the engine and are distributed more evenly and quickly, particularly when cold-starting the engine. The effect is particularly apparent in vehicles that frequently travel short distances.

Always ensure the right engine oil level is maintained and keep to the scheduled service intervals (engine oil changes).

Make sure the engine oil that you purchase expressly complies with Volkswagen oil quality standards and is the oil approved by Volkswagen for your vehicle.

**Avoid unnecessary weight**

The lighter the vehicle, the more economical and eco-friendly it will be. For example, an extra 220 lbs (100 kg) of weight increases fuel consumption by up to 1 pint per 60 miles (0.3 l/100 km).

Remove all unnecessary items and unnecessary dead weight from the vehicle.

**Remove unnecessary aftermarket components**

The more aerodynamic the vehicle, the less fuel it will consume. Aftermarket components such as bicycle racks reduce its aerodynamic performance.

Therefore, remove unnecessary structures and unused rack systems, particularly if planning to drive at higher speeds.



See additional tips on using your hybrid drive to help reduce fuel consumption.

# Steering

## Introduction

---

In this section you'll find information about:

- Warning and indicator lights
- Steering system information

The power steering system is not electro-mechanical, it is hydraulic. In both cases, the power steering works only when the engine is running.

The hydraulic power steering system uses hydraulic lines, hydraulic oil, a pump, a filter, and other parts to maintain a constant oil pressure in the hydraulic system.

The electro-mechanical power steering system automatically adjusts to driving speed, steering torque, and the steering angle of the wheels. It delivers extra steering force only when you are actually turning the wheels. The electro-mechanical power steering works only when the engine is running.

### More information:

- Starting and stopping the engine
- 12 Volt vehicle battery
- Towing

 **WARNING**

Turning the steering wheel is very hard when the power steering system is not working. This makes it harder to steer and control the vehicle.



- Power steering works only when the engine is running.
- Power steering works only when either the combustion engine or the electric motor is running.
- Never let the vehicle coast with the engine switched off.
- Never remove the key from the ignition switch while the vehicle is moving or rolling to a stop. The steering wheel will lock and you will be unable to control the vehicle.



## Warning and indicator lights

---

 Please first read and note the introductory information and heed the WARNINGS 

Lights up	Possible cause	Proper response
-----------	----------------	-----------------

Lights up	Possible cause	Proper response
	Steering system malfunction.	<b>Stop!</b> Have the power steering system checked immediately by an authorized Volkswagen dealer or an authorized Volkswagen Service Facility.
	Power steering assist is reduced.	Stop, restart the engine, and drive a short distance. If the yellow warning light does not come on again, you do <b>not</b> need to have the steering system checked. Otherwise, have the steering checked immediately by an authorized Volkswagen dealer or an authorized Volkswagen Service Facility.
	Vehicle battery was disconnected and has been reconnected.	Drive a short distance at about 10 - 12 mph (15 - 20 km/h).

Flashes	Possible cause	Proper response
	Electronic steering column lock malfunction.	<b>Stop!</b> The ignition cannot be switched on. The vehicle must not be towed! Get professional assistance.
	Steering column is twisted.	Turn the steering wheel back and forth.
	Steering column not	Switch the ignition off and then

Flashes	Possible cause	Proper response
	locked/unlocked.	switch it on again. Heed any messages shown in the instrument cluster display, if applicable. On vehicles with Keyless Access, press the starter button briefly twice in a row without depressing the brake or clutch pedal. <b>Do not drive any farther</b> if the steering column remains locked after you switch on the ignition. Contact your authorized Volkswagen dealer or an authorized Volkswagen Service Facility for assistance.

When the ignition is switched on, several warning and indicator lights come on briefly for a function check. They go out after a few seconds.

 **WARNING**

Failure to heed warning lights and instrument cluster text messages can cause the vehicle to break down in traffic and result in a collision and serious personal injury.

- Never ignore warning lights or text WARNINGS.
- Always stop the vehicle as soon as it is safe to do so.

 **NOTICE**

Failure to heed warning lights or text WARNINGS can result in vehicle damage.

## Steering system information

 Please first read and note the introductory information and heed the WARNINGS 

### Electronic steering column lock

The steering column is locked by removing the remote control vehicle key from the ignition switch when the vehicle is not moving. The electronic steering column lock does not lock if the vehicle moves for more than 10 seconds after the remote control vehicle key is removed.

Vehicles with Keyless Access: The steering column is locked if the driver door is opened with the ignition switched off. The vehicle must be standing still and the transmission must be in Park (P) on an automatic transmission vehicle.

If the driver door is opened before the ignition is switched off, the electronic steering column lock is activated only after the vehicle has been locked with the vehicle key or via the sensor in the door handle.

### **Power steering**

Power steering automatically adjusts to driving speed, steering torque, and the steering angle of the wheels. Power steering works only when the engine is running.

If power steering is reduced or lost completely, it will be much harder to steer and control the vehicle.

### **Counter-steering assistance**

Counter-steering assistance is part of Electronic Stability Control (ESC). This feature makes it easier for the driver to control the vehicle in difficult situations. For example, if you have to brake hard on a surface that provides uneven traction, the vehicle could pull to the right or left. ESC detects this situation and helps the driver counter-steer with additional steering power ⇒ ⚠.



### **WARNING**

**The counter-steering assistance in ESC can do no more than help the driver steer in difficult situations. The driver must still control the vehicle. The vehicle does not steer by itself with this feature!**



### **NOTICE**

**If the ignition is off, the steering column lock will engage and the vehicle cannot be steered. For this reason, you must leave the ignition on when going through an automatic car wash, for example, so that the wheels will still steer.**



# Hybrid drive

## Introduction

---

In this section you'll find information about:

- Warning and indicator lights
- Special driving tips
- Hybrid functions and modes
- Energy flow display
- High-voltage battery
- Special considerations for hybrid vehicles
- Removing and installing engine compartment cover

All work on the high-voltage system is dangerous, requires specialized knowledge, and should be carried out solely by authorized Volkswagen dealers and authorized Volkswagen Service Facilities that are qualified to do work on hybrid vehicles and have the training, know-how, tools, and equipment required to properly maintain, diagnose, and repair the hybrid electrical system in accordance with the standards and guidelines established by Volkswagen ⇒ .

The high-voltage network is made up of the following high-voltage components: the high-voltage battery, the power electronics (made up of the DC/DC converter and pulse inverter), the electric motor, high-voltage air conditioning compressor, and the orange-colored high-voltage cables and connectors.

### **More information:**

- Instruments
- System settings (CAR)
- Starting and stopping the engine
- Braking and parking
- Saving fuel and helping the environment
- Working in the engine compartment
- Replacing a light bulb
- Jump-starting



## DANGER

The vehicle's high-voltage electrical system and high-voltage battery are dangerous and can cause burns, other serious personal injuries, electrocution, and death.

- Always assume that high-voltage battery and parts of the high-voltage system are fully charged and energized.
- Never touch or let jewelry or other metal objects contact high-voltage cables or the high-voltage battery and battery poles, especially if the cables, battery, and battery poles have been damaged in any way.
- Never do any work yourself on the high-voltage electrical system, the orange-colored high-voltage wiring, or on the high-voltage battery.
- Never open, service, repair, or disconnect any part of the hybrid electrical system.
- Never damage the orange-colored high-voltage cables. Never remove them and never disconnect them from the high-voltage electrical system.
- Never open or remove the orange-colored cover on the high-voltage battery.
- Always have work on the hybrid electrical system and systems that could be indirectly affected by it done by qualified, trained technicians who have the know-how, experience, documentation, and tools to do the work safely.
- All work on the high-voltage electrical system and the high-voltage battery must be done in compliance with Volkswagen standards and guidelines.
- Vehicle keys must be safely stored a safe distance from vehicle so that the ignition cannot be switched on and energize the electrical system.
- Gases vented or released from the high-voltage battery vapors are potentially poisonous and can burn.
- Physical damage to the vehicle or the high-voltage battery can result in immediate or delayed release of poisonous gases that can also cause a fire.
- Always avoid contact with leaking fluids and gases escaping from the battery, particularly one that has been damaged.
- Always tell emergency responders that the vehicle has a high-voltage battery.



## WARNING

Driver distraction causes accidents and serious personal injury. Using the instrument cluster or accessing Infotainment System menus while driving can take your attention off the road and cause accidents.

- To help reduce the risk of accidents and injuries, never change settings in the instrument cluster display or use Infotainment System functions unless the vehicle is standing still.

 **WARNING**

When powered by the electric motor, the vehicle makes much less noise, both when idling and driving, than when it is running on the internal combustion engine. It is much harder or even impossible for the drivers of other vehicles and above all for cyclists, pedestrians, and children to hear the vehicle when it is running on electrical power.

- Pedestrians and others can be struck and seriously injured because they cannot hear the vehicle and tell that it is getting close to them, for instance when you are parking, backing up, or driving in a low-speed zone where there is likely to be pedestrian traffic.
- Always watch out for pedestrians, especially small children, cyclists, and others who may not hear the vehicle or realize that it is about to move or will cross their path of travel.
- Always be especially careful in residential areas, school zones, and other places where the speed of motor vehicles is restricted and pedestrians may be at greater risk.
- Make sure the ignition and the hybrid drive system have both been turned off before leaving the vehicle.

 **WARNING**

Never leave the vehicle when hybrid drive system indicator lights are still lit. The vehicle can move if the accelerator is depressed even though the combustion engine has been stopped. This can cause accidents and severe or fatal injuries.

- Make sure the transmission is in Park (P) before you get out of the vehicle.

 **WARNING**

Never support the vehicle with cinder blocks, bricks, or other objects to inspect it. The vehicle could slip or move suddenly and cause an accident with serious personal injury.

 **WARNING**

Never let the hybrid battery get wet. Liquids and other fluids can cause short circuits, electrical shock, burns, and explosions.

- Never carry large amounts of liquids or other fluids in the luggage compartment.
- Always make sure that any containers with liquids and other fluids are properly secured and tightly closed to prevent leakage during normal driving as well as hard cornering, braking, and other vehicle maneuvers. Leaking liquids can get into the cover of the high-voltage battery and the high-voltage cable connections. This can damage the electrical system and the high-voltage battery.

 Never drive until the fuel tank is completely empty. There may not always be enough charge in the high-voltage battery to get to the next gas station.

 When outside temperatures are low, a cold high-voltage battery can affect how the combustion engine starts up and can also reduce the vehicle's range in electric drive.



## Warning and indicator lights

 Please first read and note the introductory information and heed the WARNINGS 

### Warning messages

When the ignition is switched on, several warning and indicator lights come on briefly for a function check. They go out after a few seconds.

Warning lights and text messages are shown in the instrument cluster display. Acoustic warnings may also sound at the same time.

Lights up	Warnings in the instrument cluster display	Proper response
	Fault in the hybrid system: stop the vehicle at a safe location!	Stop the vehicle in a safe place as soon as it is safe to do so.
	Fault in the hybrid system: Workshop!	See an authorized Volkswagen dealer or an authorized Volkswagen Service Facility.
	Hybrid battery is charging, leave engine running.	While this message appears, do not stop the engine.
<b>READY</b>	Electric drive is READY.	Never leave the vehicle parked in the ready position. Remove the remote control vehicle key out of the ignition or for vehicle with Keyless Access press the starter button ⇒ page 395. When leaving the vehicle always take the remote control vehicle key with you.
<b>E-MODE</b>	Extended electro-mode drive active.	
<b>E-MODE</b>	E-MODE currently not available.	Check to see if the requirements for extended electro-mode drive are met
	Vehicle can still be driven.	

Lights up	Warnings in the instrument cluster display	Proper response
	Electric driving is currently not possible.	Never leave the vehicle parked in the ready position. Remove the remote control vehicle key out of the ignition or for vehicle with Keyless Access press the starter button.
	Request to start the engine.	Start the engine with the ignition switch or starter button.

#### Warning when leaving the vehicle

Switch off the ignition before leaving the vehicle unattended ⇒ *Starting and stopping the engine*. In certain situations, a message **Ignition on** appears in the instrument cluster display as you are leaving the vehicle. This message warns you that the vehicle's electric drive is still enabled and that the combustion engine might start automatically.

Always switch the engine off, remove the key, and take it with you when leaving the vehicle ⇒ . As a reminder to do so, the combustion engine may start automatically under the following conditions:

- The ignition is switched ON.
- **AND:** Electrical drive is functional (Ready).
- **AND:** The transmission is in Park (**P**) or Neutral (**N**).
- **AND:** The driver safety belt is not fastened. **OR** The driver door is open.

The message in the instrument cluster display also reminds you to switch the ignition off. In addition, always be sure to apply the parking brake, remove the key, and take it with you when leaving the vehicle.

#### WARNING

A parked vehicle that is not properly parked can roll away and cause accidents or severe injuries. When leaving the vehicle, always move the selector lever into Park (**P**) and engage the electronic parking brake.

#### WARNING

Failure to heed warning lights and instrument cluster text messages can cause the vehicle to break down in traffic and result in a collision and serious personal injury.

- Never ignore warning lights or text WARNINGS.
- Always stop the vehicle as soon as it is safe to do so.

#### NOTICE

Failure to heed warning lights or text WARNINGS can result in vehicle damage.

## Special driving tips

☐ Please first read and note the introductory information and heed the **WARNINGS** ⚠

This short overview cannot replace the detailed description in this entire chapter, especially not the warnings or safety instructions.

Driving situations	Requirements and conditions	Vehicle behavior
Electrical driving.	– Selector lever in position <b>(D)</b> .	If all operative requirements of the Hybrid system are fulfilled, the vehicle starts electrically. The combustion engine is switched on only at higher speeds.
	– Foot brake released.	
	– Accelerator is slightly depressed.	
Constant driving and gliding without engine on (Sailing).	– Thinking ahead when driving, with careful acceleration.	The kinetic energy of the vehicle is used optimally for its motion ahead. No energy is lost through excessive acceleration or braking.
	– Reducing speed early or completely in case of obstacles or speed limits.	By easing off the accelerator completely, the combustion engine is automatically switched off and disconnected. The vehicle glides (sails) without engine power, and friction losses are minimized.
Full acceleration (Boost).	– Selector lever in position <b>(D)</b> . Kick-down mechanism of accelerator activated. – Accelerator fully depressed or kick-down acceleration activated.	The electric motor assists the combustion engine in acceleration. The maximum overall output is used <i>briefly</i> .
	– Selector lever in position <b>S</b> or Tiptronic: accelerator is depressed to 80%.	

Driving situations	Requirements and conditions	Vehicle behavior
Braking energy regeneration (Recuperation).	– Early and even braking with short brake pedal travel.	The vehicle is braked by the electric motor. Most of the kinetic energy is then won back and can be stored in the form of electrical energy in the high-voltage battery.
Driving in city traffic.	– Selection of a moderate speed.	Driving in fully electric mode at this level is possible only with a speed of up to approximately 50 km/h (31 mph).
	– Avoid full acceleration.	The fuel consumption is reduced with moderate acceleration due to higher efficiency of the combustion engine and driving in fully electric mode is possible.
	– Careful use of <b>E-MODE</b> button ⇒ <a href="#">fig. 257</a> .	The high-voltage battery discharges quickly with the <b>E-MODE</b> button switched on. This can increase fuel consumption since driving in electric mode is preferred in this case, even though the combustion engine would be more efficient.
Driving on country roads and highways.	– Conscious easing off of the accelerator, to enable longer sailing distance.	By easing off the accelerator, the combustion engine is automatically switched off and de-clutched. The vehicle glides without engine power.
	– Reducing speed by easing off the accelerator early and not by braking.	Sailing possible. Reduction of speed this way is more fuel-efficient than through braking.

Driving situations	Requirements and conditions	Vehicle behavior
	<ul style="list-style-type: none"> <li>– Avoid speeds of over about 160 km/h (99 mph).</li> </ul>	Efficient sailing is possible with a speed of about 160 km/h (99 mph).
	<ul style="list-style-type: none"> <li>– Careful selection of gear <b>(S)</b>.</li> </ul>	Sporty driving style with activated sport program increases fuel consumption. Efficient sailing in sport program with combustion engine automatically switched off is possible with a speed of about 70 km/h (43 mph).
Driving in cold months.	<ul style="list-style-type: none"> <li>– Do not warm up the combustion engine by running it with the vehicle stationary.</li> </ul>	The temperature of the combustion engine increases very slowly, but fuel consumption increases considerably.
	<ul style="list-style-type: none"> <li>– Careful use of heating for the rear window, outside mirror, steering wheel and front seats.</li> </ul>	This prevents energy from being lost and saves energy for the electric motor.
	<ul style="list-style-type: none"> <li>– Leave the vehicle in a garage overnight.</li> </ul>	This prevents the high-voltage battery and the vehicle interior from cooling down too much. The optimal temperature of the high-voltage battery is reached quicker at the beginning of the journey and the combustion engine can be switched off quicker when the vehicle interior is sufficiently heated.



## Hybrid functions and modes



Fig. 257 In the lower center console: E-MODE button for extended electro-mode drive.

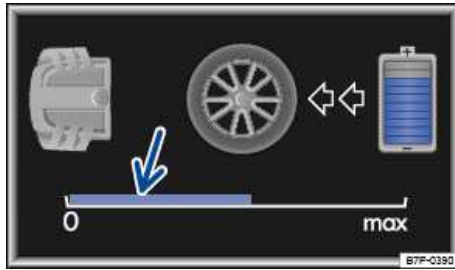

Fig. 258 Hybrid menu in the instrument cluster display: Current electric power level.

### ⚠ Please first read and note the introductory information and heed the WARNINGS ⚠

The functions and operating modes described below are controlled automatically by the vehicle management system depending on how the vehicle is being driven. This helps to ensure that the vehicle operates in the best mode at all times. Extended electro-mode drive (**E-MODE**) is an exception, however. The driver must manually select this mode ⇒ *Extended electro-mode drive (E-MODE)*.

#### Combustion engine drive

In this mode, the vehicle is powered by the combustion engine. The electric motor acts as an alternator and recharges the vehicle's high-voltage battery. It also supplies the 12 Volt power system at the same time.

A message may also appear in the instrument cluster to let you know that the combustion engine is active.

#### Full-acceleration (Boost)

For full acceleration, the vehicle is powered by the combustion engine and the electric motor. This *Boost* mode is available only for a short period because it uses a lot of the battery's charge.

Boost mode is activated by:

- Kick-down when the transmission is in Drive (**D**).
- **OR**: Heavy acceleration when the transmission is in Sport Drive (**S**).
- **OR**: Heavy acceleration when the transmission is in Tiptronic mode.

#### Electrical motor drive

The vehicle can be powered by the electrical motor at low to moderate speeds, provided the high-voltage battery charge is adequate and wind resistance is not too strong. The combustion engine is

switched of in this mode. Gentle start-ups (getting the vehicle going) and parking are also phases the electrical motor can often handle alone.

The combustion engine is started if you accelerate faster or if the charge level of the high-voltage battery gets too low. As soon as allowed by your acceleration and the high-voltage battery charge level, the vehicle switches back to electrical motor drive.

Use the following indicators to tell when the vehicle is being powered electrically:

- Tachometer for the combustion engine shows zero engine revolutions.
- Instrument cluster display.
- Infotainment System screen.

### Extended electro-mode drive (E-MODE)

By pressing the **E-MODE** button ⇒ [fig. 257](#), the driver can extend the normal limits of electrical motor drive so that the electric motor powers the vehicle whenever possible (given the battery charge level and the way you are driving). In this mode, the vehicle is propelled by the electric motor as much as possible.

Extended electro-mode drive can be **activated** only if all of the following conditions apply:

- The high-voltage battery must have an adequate charge.
- The transmission must not be in Sport (**S**) or Tiptronic mode.
- The speed must be below 45 mph (70 km/h).
- The driver must accelerate gently.

If extended electro-mode drive is not possible, a message appears in the instrument cluster display.

The activation of the extended electro-mode drive will be indicated by the symbol **E-MODE** in the instrument cluster display.

The combustion engine starts and **interrupts** extended electro-mode drive if the first 2 conditions change. Then the color of the symbol **E-MODE** changes from green to *grey*. Extended electro-mode drive resumes automatically as soon as all conditions listed above apply again and the symbol **E-MODE** changes to *green*.

Extended electro-mode drive is **deactivated** if any of the following conditions apply:

- Ignition is switched off.
- **E-MODE** button is pushed a second time.
- Transmission is in Sport Drive (**S**).
- Transmission is in Tiptronic mode.
- Speed is greater than about 45 mph (70 km/h).

To reactivate, press the **E-MODE** button again.

### Electric power level display (E-Powermeter)

The electric power level is shown in the MFI display ⇒ [fig. 258](#) (arrow). When the power level display reaches its **maximum**, the vehicle automatically switches to the combustion engine. By accelerating gently it is possible to drive the vehicle using electric energy only.

The power level display is activated during electric drive and at full acceleration (Boost). When the vehicle is fully accelerated, the display is constantly in the **maximum** area.

The power level display only appears when the vehicle is being driven with the electric motor.

In all other driving modes, the power level display is deactivated so that the bar is not shown.

### Start-Stop mode

The combustion engine is operated only as needed. When the vehicle is stopped the combustion engine is normally off. The vehicle electrical systems are supplied with power from the high-voltage battery. The instrument cluster tachometer will show zero engine speed (zero engine revolutions).

This depends on vehicle conditions of the hybrid drive system is normal and is designed to save fuel. The power steering and the braking assistance systems remain active. In certain situations it may be necessary for the system to start the combustion engine even when the vehicle is not moving. With prolonged driving in traffic jams, the combustion engine will be switched on and off to charge the high-voltage battery for the following start-stop phase.

### **Sailing**

If the accelerator is not depressed and the lever is in Drive **(D)**, the internal combustion engine is switched off even at higher speeds. The vehicle then decelerates slower than conventional vehicles.

This feature can be used to help reduce fuel consumption when you keep traffic conditions in mind and can anticipate the vehicles power requirements. Even in this case, the rev counter in the instrument cluster displays zero engine speed (0 engine revolutions). The instrument cluster powermeter shows zero.

### **Brake energy regeneration (Recuperation/charge)**

When the vehicle brakes, the electrical energy is generated by the electric motor, which works as an alternator and charges the high-voltage battery. The same thing occurs while the vehicle is coasting to a stop or driving downhill.

Energy regeneration is shown in the instrument cluster display or on the Infotainment System screen. The combustion engine may be switched off automatically in this situation. The instrument cluster powermeter registers below zero.

When the high voltage battery is fully charged, there is no brake energy recuperation, and therefore no engine braking. Recuperation and engine braking are also automatically reduced if the vehicle detects that the road conditions do not permit sufficient contact between the wheels and the road surface.

### **Automatic starting - combustion engine**

The combustion engine is started automatically in a number of situations.

- Engine temperature is too low.
- Catalytic converter temperature is too low.
- High-voltage battery being charged at high rate when decelerating. The high-voltage battery cannot absorb any more energy and for this reason the electric motor cannot brake the vehicle. The combustion engine comes on to help slow the vehicle down (engine brake).
- Engine hood is open.
- Leaving the vehicle when the electric motor is still "live". The status of the electric motor is not always obvious, particularly when the combustion engine is not running. The combustion engine will therefore start if the driver's safety belt is unlatched or the driver's door is opened when the transmission is in Park **(P)** or Neutral **(N)** ⇒ *Warning when leaving the vehicle.*

## Energy flow display

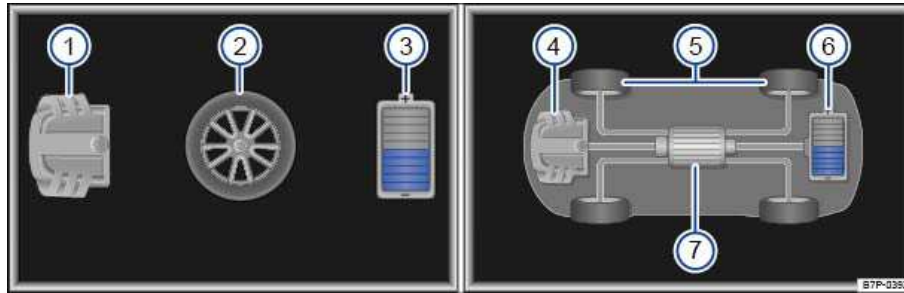

Fig. 259 Energy flow display (Variant 1). Left: Instrument cluster. Right: Infotainment System.

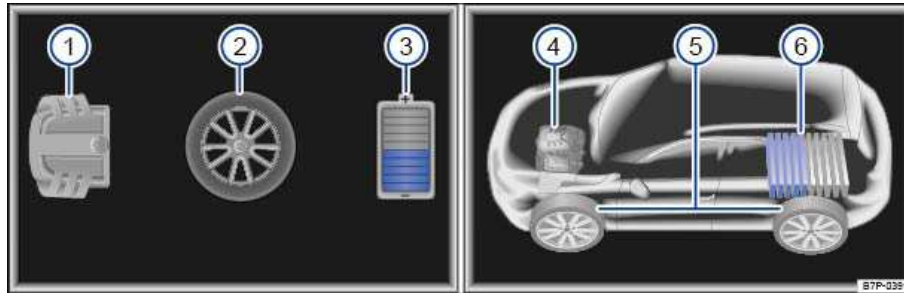

Fig. 260 Energy flow display (Variant 2). Left: Instrument cluster. Right: Infotainment System.

**⚠ Please first read and note the introductory information and heed the WARNINGS ⚠**

Hybrid drive energy flow is shown with symbols and arrows in the instrument cluster display (MFI) and on the Infotainment System screen. The displays let you know whether the electric motor or the engine is active while driving.

Explanation of the symbols that appear in the energy flow display when the vehicle is not moving

⇒ fig. 259:

- (1) Symbol for combustion engine in **instrument cluster display**.
- (2) Symbol for vehicle drive in **instrument cluster display**.
- (3) Symbol for high-voltage battery in **instrument cluster display**.
- (4) Symbol for combustion engine on the **Infotainment System screen**.
- (5) Symbol for electric motor on the **Infotainment System screen**.
- (6) Symbol for high-voltage battery on the **Infotainment System screen**.
- (7) Symbol for vehicle drive on the **Infotainment System screen**.

### Color codes

Color	Infotainment System screen
Orange	Energy flow from combustion engine (combustion engine drive).

Color	Infotainment System screen
Blue	Energy flow <b>from</b> the high-voltage battery (electrical motor drive). Energy flow <b>to</b> the high-voltage battery (battery charge).
Green	Energy regeneration through deceleration or braking (recuperation).

## High-voltage battery

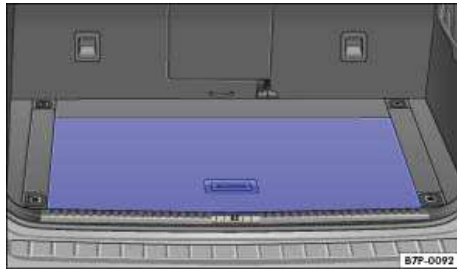

Fig. 261 Location of the high-voltage battery: under the luggage compartment floor.

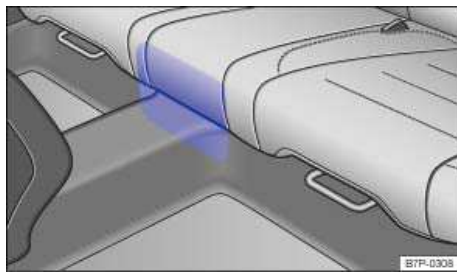

Fig. 262 Air ventilation for the high-voltage battery under the rear seat bench.

⚠ Please first read and note the introductory information and heed the WARNINGS ⚠

The high-voltage battery is under the luggage compartment floor ⇒ fig. 261.

### Cooling the high-voltage battery

There are ventilation slots under the rear seat bench that provide the high-voltage battery with cool air.

The ventilation area under the rear seat bench ⇒ fig. 262 must not be blocked or covered ⇒ ⚠.

### Maintenance of the high-voltage battery

Other than taking the vehicle in for scheduled maintenance to an authorized Volkswagen dealer or an authorized Volkswagen Service Facility that is qualified to do work on hybrid vehicles, there is nothing that the vehicle driver has to do to maintain the high-voltage battery.

The maintenance connection for the high-voltage battery is under the luggage compartment floor under an orange cover. This connection is **only** for scheduled maintenance, which must be performed **only** by specially trained service technicians. There is no need to remove the connector at any time when the vehicle is being used => ⚠

#### WARNING

The high-voltage hybrid electrical system is dangerous and can cause burns, other serious personal injuries, electrocution and death.

- Never open, service, repair, or disconnect the high-voltage hybrid battery.
- Never touch or let jewelry or other metal objects contact high-voltage cables or the high-voltage battery and battery poles, especially if the cables, battery, or battery poles have been damaged in a crash or in some other way.
- Always have work on the hybrid electrical system and on systems that could be indirectly affected by it done by qualified, trained technicians, who have the know-how, experience, documentation, and tools to do the work safely.

#### WARNING

Failure to heed warning lights and instrument cluster text messages can cause the vehicle to break down in traffic and result in a collision and serious personal injury.

- Never ignore warning lights or text WARNINGS.
- Always stop the vehicle as soon as it is safe to do so.

#### NOTICE

- Failure to heed warning lights or text WARNINGS can result in vehicle damage.
- If the 12 Volt vehicle battery is disconnected or dead or has been replaced, there is a possibility that the combustion engine will not automatically switch off when the vehicle is powered by the electric motor. If this situation persists for several days, take the vehicle to an authorized Volkswagen dealer or an authorized Volkswagen Service Facility that is qualified to do work on hybrid vehicles.
- Never transport water or other liquids or fluids in open containers, such as an aquarium. If liquid is spilled in the luggage compartment, this can cause short circuits or damage the high-voltage battery.

#### NOTICE

Never block or cover the cooling air vents for the high-voltage hybrid battery under the rear seat. Blocking or covering these vents can damage the high-voltage battery.

# Starting assistance systems

## Introduction

---

In this section you'll find information about:

Warning and indicator lights

Hill Hold

Hill Descent Assist

### More information:

- Volkswagen Information System
- Tires and wheels
- Braking and parking
- 12 Volt vehicle battery
- Parts, accessories, repairs and modifications
- Jump-starting

### WARNING

The intelligent technology of the dynamic starting assistance features cannot overcome the laws of physics. Never let the increased convenience provided by the dynamic starting assistance features tempt you into taking risks.

- Unintended vehicle movement can cause serious personal injury.
- The dynamic starting assistance features are no substitute for careful and attentive driving.
- Always adapt your speed and driving style to visibility, weather, road, and traffic conditions.
- The dynamic starting assistance features cannot keep the vehicle from moving in all hill-start situations (for example, if the ground is slippery or icy).
- Never activate the throttle manually from the engine compartment when the engine is running and the automatic transmission is in gear. The vehicle will start to move as soon as the engine speed increases, even if the parking brake is set.

### WARNING



Driving with too little fuel in the fuel tank increases the risk of stalling, especially when driving up and down hills.

- If your vehicle stalls suddenly, this can cause an accident and serious personal injuries.
- Driver assistance and braking assistance systems can malfunction when there is too little fuel in the tank and cause you to lose control of the vehicle.
- Never drive until the fuel tank is almost empty.

## Warning and indicator lights

---

 Please first read and note the introductory information and heed the WARNINGS 

Lights up	Possible cause	Proper response
	Hill Hold malfunction.	Take the vehicle to an authorized Volkswagen dealer or an authorized Volkswagen Service Facility and have the system checked.
	Hill Descent Assist switched on.	

Flashes	Possible cause	Proper response
	Hill Descent Assist is operating.	

When the ignition is switched on, several warning and indicator lights come on briefly for a function check. They go out after a few seconds.

### WARNING

Failure to heed warning lights and instrument cluster text messages can cause the vehicle to break down in traffic and result in a collision and serious personal injury.

- Never ignore warning lights or text WARNINGS.
- Always stop the vehicle as soon as it is safe to do so.

### NOTICE

Failure to heed warning lights or text WARNINGS can result in vehicle damage.

## Hill Hold

 Please first read and note the introductory information and heed the WARNINGS 

Hill Hold helps keep the vehicle from rolling backwards when starting out on a hill, for example after stopping at a traffic light. You don't have to apply and release the parking brake while depressing the accelerator. For Hill Hold to work, the engine must be running and the vehicle must be in Drive (D) or Sport Drive (S) and you must use the foot brake to hold the vehicle before starting to move.

Hill Hold keeps the brake applied for not quite 2 seconds with the same force you used to prevent the vehicle from moving. This gives you time to take your foot off the brake, and gently depress the accelerator to get the vehicle moving again. If you do not depress the accelerator pedal and get the vehicle moving again within this time, the brakes will release and the vehicle will roll downhill. Furthermore, if



any requirement for engaging Hill Hold is no longer met while the vehicle is stopped, Hill Hold disengages, the indicator light in the button goes out, and the brakes are automatically released and will no longer hold the vehicle.

**Hill Hold is activated automatically when points 1 to 3 are met at the same time:**

1.	Hold the <b>stopped</b> vehicle on an incline with the foot brake or electronic parking brake.
2.	The engine is running “smoothly”.
3.	The transmission must be in Drive ( <b>D</b> ) or Sport Drive ( <b>S</b> ) and the foot brake must be depressed to keep the vehicle from moving.
4.	To drive off, take your foot off the brake pedal and gently depress the accelerator within 2 seconds.
	<b>Release the brake as you gently depress the accelerator.</b>

**Hill Hold is immediately deactivated:**

- If any requirement listed in the table above is no longer met (see ⇒ table on page 453).
- If the engine is not running smoothly or the engine malfunctions.
- If the engine stalls or is switched off.
- If the transmission is in Neutral (**N**).
- If a tire does not have enough road contact (such as when the vehicle is tipped or at an angle).

 <b>WARNING</b>
<p>The intelligent technology of Hill Hold cannot overcome the laws of physics. Never let the increased convenience provided by Hill Hold tempt you into taking risks.</p> <ul style="list-style-type: none"><li>• The Hill Hold feature cannot hold the vehicle in all hill start situations (for example, if the surface is icy or slippery).</li><li>• Hill Hold can only help keep the vehicle from moving for less than 2 seconds. After that, the brakes will be released and the vehicle can roll down the hill.</li></ul>

## Hill Descent Assist

 Please first read and note the introductory information and heed the **WARNINGS** 

Hill Descent Assist helps the driver on steep downhill grades by actively braking the vehicle. The vehicle is held to the speed it has when Hill Descent Assist first begins to work ⇒ .

One requirement for speed regulation is that the tires must have a sufficiently good grip on the ground underneath. For example, Hill Descent Assist **cannot** perform its function on icy slopes or on slopes with an oily road surface.

An indicator light  comes on in the instrument cluster display whenever Hill Descent Assist is enabled. The indicator light *blinks* when Hill Descent Assist is regulating the brakes.

Hill Descent Assist is always enabled, but only regulates the brakes when certain requirements are met.

**Hill Descent Assist regulates automatically:**

- If the vehicle is in off-road mode and the indicator light  is on.
- **And:** If your speed is under 18 mph (30 km/h).
- **And:** If the downhill grade is 10 % or steeper.
- **And:** If you neither accelerate nor apply the brakes.
- **And:** If the vehicle's engine is running.

If you accelerate or step on the brake when Hill Descent Assist is operating, the feature switches off. Hill Descent Assist begins regulating speed again the next time the requirements are met.

**Hill Descent Assist does not regulate speed:**

- On downhill grades of less than 10 %.
- **OR:** At speeds over 18 mph (30 km/h).
- **OR:** If the driver brakes or accelerates.

 **WARNING**

**Always be ready to apply the brakes. Otherwise accidents and injuries can occur.**

- **Hill Descent Assist is merely a driving aid and cannot always slow the vehicle down enough under on downhill grades.**
- **The vehicle may pick up speed despite the use of Hill Descent Assist.**



The Hill Descent Assist also works when you are backing down a hill.

# Cruise Control System (CCS)

## Introduction

---

In this section you'll find information about:

Warning and indicator lights  
Warning and indicator lights  
Cruise control operation

The Cruise Control System (CCS) helps maintain an individually stored constant speed when driving above about 12 mph (20 km/h).

The CCS slows down the vehicle only by reducing the flow of fuel to the engine, not by braking ⇒ .

### More information:

- Shifting
- Parts, accessories, repairs and modifications

### WARNING

**Using the cruise control when it is not possible to drive safely at a constant speed can be dangerous and can lead to an accident and serious personal injury.**

- **Never use cruise control when driving in heavy or varying traffic or when you cannot keep a safe distance between you and the vehicles, ahead of you.**
- **Never use cruise control on steep, winding, or slippery roads (such gravel roads, wet roads, or snowy or icy roads) or on roads with standing water.**
- **Never use cruise control when driving off-road or on unpaved roads.**
- **Always adjust your speed and the distance you keep between you and the vehicles ahead of you to the road, traffic, weather, and visibility conditions.**
- **To help prevent unintended operation of cruise control, switch the system off when it is not being used.**
- **It is dangerous to use the Resume feature when the previously set speed is too high for the existing road, traffic, or weather conditions.**
- **When traveling downhill, the cruise control may not be able to maintain a constant speed. The vehicle will speed up because of its own weight. Downshift and/or use the foot brake to slow the vehicle.**

## Warning and indicator lights

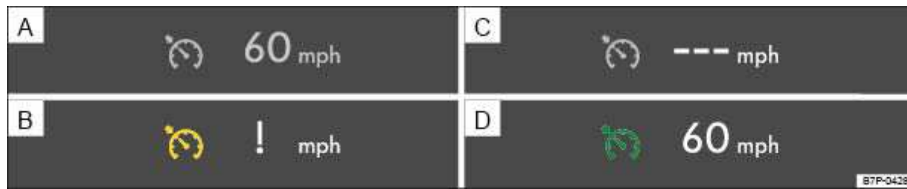

Fig. 266 In the instrument cluster display: Cruise control status indications.

⚠ Please first read and note the introductory information and heed the WARNINGS ⚠

### Display

Different cruise control versions are available. The stored speed is shown in the instrument cluster display on some equipment versions.

Status ⇒ fig. 266

- (A) Cruise control temporarily deactivated.
- (B) System malfunction. See an authorized Volkswagen dealer or an authorized Volkswagen Service Facility.
- (C) Cruise control activated. No speed stored in memory.
- (D) Cruise control is active.

Lights up	Possible cause
	Cruise Control System malfunction ⇒ fig. 266 B.
	Cruise control is regulating vehicle speed.
<b>CRUISE</b>	
	Cruise control is switched on, but <b>not</b> active.

When the ignition is switched on, several warning and indicator lights come on briefly for a function check. They go out after a few seconds.

### ⚠ WARNING

Failure to heed warning lights and instrument cluster text messages can cause the vehicle to break down in traffic and result in a collision and serious personal injury.

- Never ignore warning lights or text WARNINGS.
- Always stop the vehicle as soon as it is safe to do so.

### ⓘ NOTICE

Failure to heed warning lights or text WARNINGS can result in vehicle damage.

# Adaptive Cruise Control (ACC) with Front Assist

## Introduction

---

In this section you'll find information about:

Display, warning and indicator lights

Radar sensors, ultrasonic sensors and Front Assist camera

Switching ACC on and off

When to temporarily deactivate Adaptive Cruise Control (ACC)

Forward Collision Warning system (Front Assist)

Temporarily switch off the Forward Collision Warning system (Front Assist) in the following situations

Forward Collision Warning system (Front Assist) system limits

Autonomous Emergency Braking

Special driving situations

The Adaptive Cruise Control system (ACC) helps maintain an individually stored constant speed between about 20 mph (30 km/h) and 95 mph (150 km/h) and a previously set distance in time intervals between your vehicle and those in front of you.

ACC uses radar, ultrasonic and video sensors installed on your vehicle. Moving vehicles in front of yours can be detected within a distance of up to 590 ft (180 m).

The vehicle may be braked, if the situation so requires, **to a standstill** by an **active braking maneuver** ⇒ .

Adaptive Cruise Control has system-specified limits. As a driver, you must control the speed and the distance to other vehicles under some circumstances. If that is necessary, the system requests the driver to take over using a visual and audible warning.

### **How does Adaptive Cruise Control (ACC) work?**

Adaptive Cruise Control requires you to set the desired speed and distance. Set and adjust the speed using the lever to the left of the steering column. Set the distance using the sliding switch on top of the lever.

### **Driver intervention warning**

Adaptive Cruise Control has system-specified limits. As a driver, you must control the speed and the distance to other vehicles under some circumstances. If that is necessary, the system requests the driver to take over using a visual and audible warning ⇒ table on page 461, even if the vehicle can be braked to a standstill by an active braking maneuver.

### **More information:**

- Exterior views
- Shifting
- Parts, accessories, repairs and modifications
- Cruise Control system CCS

## WARNING

Always remember that the Adaptive Cruise Control has limits – Using Adaptive Cruise Control when it is not possible to drive safely at a constant speed can be dangerous and can lead to an accident and serious personal injury.

- Adaptive Cruise Control will not slow the vehicle down or maintain the set distance when you drive towards an obstacle or something on or near the road that is not moving, such as vehicles stopped in a traffic jam, a stalled or disabled vehicle.
- Always adjust your speed and the distance you keep between you and the vehicles ahead of you to the road, traffic, weather, and visibility conditions.
- Never use Adaptive Cruise Control on steep, winding, or slippery roads (such gravel roads, wet roads, or snowy or icy roads) or on roads with standing water.
- Never use Adaptive Cruise Control when driving in heavy or varying stop-and-go traffic.
- Never use Adaptive Cruise Control when driving off-road or on unpaved roads.
- Always remember that the Adaptive Cruise Control cannot detect a vehicle that is driving towards you in your traffic lane and that it cannot detect narrow vehicles such as motorcycles and bicycles.
- Never follow a vehicle so closely that you cannot stop your vehicle safely. The Adaptive Cruise Control cannot slow or brake the vehicle safely when you follow another vehicle too closely. Always remember that the Adaptive Cruise Control has a braking power that is only about 30% of the vehicle's maximum braking ability, under certain circumstances the automatic braking function cannot bring the vehicle to a stop in time.
- Always turn off Adaptive Cruise Control when entering turn lanes, exit lanes and construction zones or in similar situations because the vehicle will automatically accelerate to the stored speed when the road ahead is clear.
- To help prevent unintended operation of Adaptive Cruise Control, switch the system off when it is not being used.
- It is dangerous to use the Resume feature when the previously set speed is too high for the existing road, traffic, or weather conditions.
- When traveling downhill, the Adaptive Cruise Control may not be able to maintain a constant speed. The vehicle will speed up because of its own weight. Downshift and/or use the foot brake to slow the vehicle.
- Never allow the closing speed between you and other vehicles to be so high that the Adaptive Cruise Control may not be able to slow your vehicle safely. If closing speed is too high, you must apply the brakes yourself to reduce the risk of a rear-end crash.
- If a driver intervention warning appears in the instrument cluster display, immediately takeover the control of the brake and gas pedals and low down the vehicle or bring it to stop when necessary and according to the traffic situation.
- If a Forward Collision Warning system (Front Assist) collision warning appears in the instrument cluster display, immediately takeover the control of the brake and gas pedals and low down the vehicle or bring it to stop when necessary and according to the traffic situation.
- Always be prepared to takeover the control of the brake and the gas pedal in every situation.

## NOTICE

If you suspect that ACC and the Forward Collision Warning system (Front Assist) don't work properly or the sensors are damaged, switch off ACC immediately.

- Go see an authorized Volkswagen dealer or Volkswagen Service Facility for assistance and have the ACC system checked.

## Display, warning and indicator lights

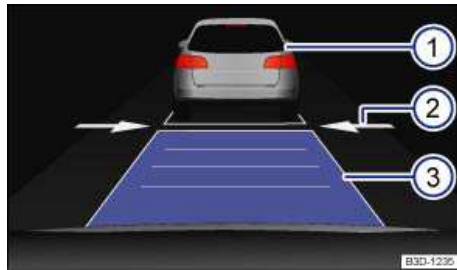

**Fig. 269** In the instrument cluster display: ACC is active and the maximum distance is set to the detected vehicle in front.

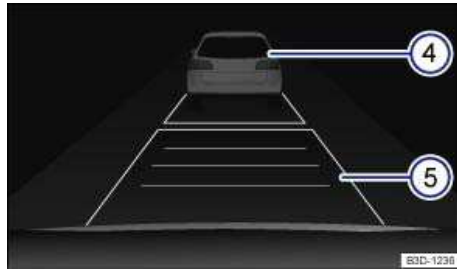









**Fig. 270** In the instrument cluster display: ACC is not active but a vehicle was detected in front.

⚠ Please first read and note the introductory information and heed the **WARNINGS** ⚠

Keys to ⇒ [fig. 269](#) and ⇒ [fig. 270](#)

- (1) Vehicle traveling ahead (ACC active)
- (2) Indicator for setting the time distance to the vehicle traveling ahead (adjustable with sliding switch)
- (3) Set time distance to vehicle traveling ahead (ACC active)
- (4) Vehicle traveling ahead (ACC not active)
- (5) Set time distance to vehicle traveling ahead (ACC not active)

Lights up	Possible cause ⇒ ⚠	Proper response
	The deceleration of the ACC automatic braking system is not sufficient to bring the vehicle to a full stop in time.	<b>Depress the brake pedal!</b> Driver intervention warning!
	An obstacle was detected when driving off.	Drive slowly and be prepared to stop!

Lights up	Possible cause ⇒ 	Proper response
	Front assist collision warning. the Forward Collision Warning system (Front Assist) detected an impending collision with a vehicle driving ahead of yours ⇒ page 469.	<b>Depress the brake pedal!</b> Try to avoid a collision by braking the vehicle and/or drawing it aside according to the traffic situation!
	Adaptive Cruise Control (ACC) is currently not available,	Park your vehicle and turn the engine off and on again. Check the sensor for damages or soiling. Should the system still not be available, have it checked by an authorized Volkswagen dealer or Volkswagen service facility.
	The Forward Collision Warning system (Front Assist) or Adaptive Cruise Control (ACC) is out of order and not active.	Have the system checked by an authorized Volkswagen dealer or Volkswagen service facility.
	Adaptive Cruise Control (ACC) is active and regulating the speed and distance to the vehicle travelling in front of you.	-
	Adaptive Cruise Control (ACC) is active and holding the vehicle at the set speed.	-
	Adaptive Cruise Control (ACC) is not active but the system is on and detected a vehicle travelling in front of you.	-



Lights up	Possible cause ⇒ ⚠	Proper response
	Adaptive Cruise Control (ACC) is not active, the system is on but not regulating or holding speed.	-

When the ignition is switched on, several warning and indicator lights come on briefly for a function check. They go out after a few seconds.

### ⚠ WARNING

Failure to heed warning lights and instrument cluster text messages can cause the vehicle to break down in traffic and result in a collision and serious personal injury.

- Never ignore warning lights or text WARNINGS.
- Always stop the vehicle as soon as it is safe to do so.

### ⓘ NOTICE

Failure to heed warning lights or text WARNINGS can result in vehicle damage.

## Radars sensors, ultrasonic sensors and Front Assist camera

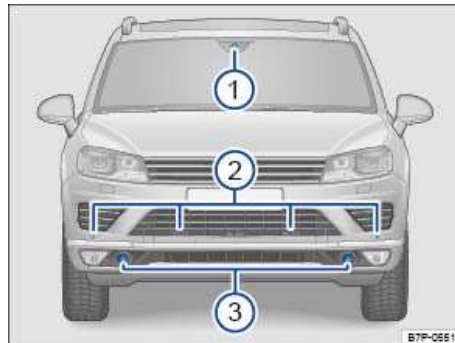

Fig. 271 Vehicle front view: Sensors and camera

ⓘ Please first read and note the introductory information and heed the WARNINGS ⚠

Key to ⇒ fig. 271:

- (1) Camera for Front Assist system
- (2) Ultrasonic sensors for the Adaptive Cruise Control (ACC)
- (3) Radar sensors for the Adaptive Cruise Control (ACC) and Front Assist

There are 2 radar sensors next to the fog lights on the vehicle front (3). These can detect moving vehicles up to 590 ft (180 m) in front of your vehicle.

The areas of the sensors (2) and (3) and the camera (1) must not be spray painted on or covered by stickers or other objects, since this can lead to a malfunction of the Adaptive Cruise Control (ACC) and the Front Assist system.

## ! NOTICE

If you notice that Adaptive Cruise Control (ACC) or Front Assist doesn't work properly or the sensors are damaged, switch off ACC immediately.

- Go see an authorized Volkswagen dealer or Volkswagen Service Facility for assistance and have the ACC system checked.
- The sensors can be damaged or become misaligned in low speed impacts and parking maneuvers. Damaged or misaligned sensors can cause ACC or Front Assist to malfunction.
- To help make sure that the system works properly, always keep the sensors clean, free of snow and ice; do not cover the sensors with stickers or other objects.
- When cleaning the sensors with power washers or steam cleaners, only spray the sensors directly for a very short time, and always keep the washer nozzle at least 4 inches (10 cm) from the sensors.
- For Declaration of Compliance to United States FCC and Industry Canada regulations

**i** Always keep the area of the Front Assist camera clear of ice and snow.

## Switching ACC on and off



Fig. 272 On the steering wheel column: Lever for Adaptive Cruise Control.



Fig. 273 Lever for Adaptive Cruise Control: Setting the distance (time intervals)

☑ Please first read and note the introductory information and heed the **WARNINGS** ⚠

In order to:	You must ⇒ <b>fig. 272</b> :	Result:
Switch on ACC	Bring lever to position <b>ON</b> (1).	ACC is switched on, but not activated.
Activate ACC	Push <b>SET</b> (3) button <i>briefly</i> .	Current speed is set and the system starts to actively regulate the speed ⇒ Ⓜ.
Temporarily deactivate ACC	Push the lever <i>briefly</i> to the <b>CANCEL</b> position (4).  <b>Or:</b> Depress the brake pedal	Speed regulation is temporarily deactivated. The set speed is still stored.
Resume speed regulation (re-activate ACC)	Pull the lever <i>briefly</i> to the <b>RESUME</b> position (1).	The speed regulation will be resumed at the stored speed value ⇒ Ⓜ.
Increase set speed (while ACC is actively regulating vehicle speed).	Pull the lever <i>briefly</i> to the <b>RESUME</b> position (1), in order to increase set speed and store new speed value in increments of 1 mph (1 km/h).	The vehicle will accelerate until the new higher speed is reached and saves the new higher speed in the memory.
	Pull and hold the lever to the <b>RESUME</b> position (1) position to increase the set speed continuously until the higher desired speed is reached and the lever is released.	
	Push the lever <i>briefly</i> to the <b>SPEED +</b> position (2) position to increase the set speed in increments of 5 mph (10 km/h) and store.	

In order to:	You must ⇒ <a href="#">fig. 272</a> :	Result:
	<p>Push and hold the lever in the <b>SPEED + (2)</b> position to increase the set speed continuously until the higher desired speed is reached and the lever is released.</p>	
<p>Reduce set speed (while ACC is actively regulating but the set vehicle speed is not reached yet).</p>	<p>Push the lever <i>briefly</i> to the <b>SPEED – position (5)</b> to reduce the set speed in increments of 5 mph (10 km/h) and store.</p> <p>Afterwards the new set speed can be reduced in increments of 1 mph (1 km/h) by pushing the <b>SET (3)</b> button.</p> <p>Push and hold the lever <i>longer</i> in the <b>SPEED – position (5)</b> to reduce the set speed continuously until the lower desired speed is reached and the lever is released.</p>	<p>The speed will be continuously reduced until the new lower speed is reached.</p>
<p>Reduce set speed (while ACC is actively regulating and the set speed has been reached).</p>	<p>Press <b>SET (3)</b> button <i>briefly</i>, in order to decrease set speed and store new speed value in increments of 1 mph (1 km/h).</p> <p>Push and hold <b>SET (3)</b> button <i>long</i> to reduce the set speed continuously until the lower desired speed is reached and the lever is released.</p> <p>Push the lever <i>briefly</i> to the <b>SPEED – position (5)</b> to reduce the set speed in increments of 5 mph (10 km/h) and store.</p>	<p>The speed will be continuously reduced until the new lower speed is reached.</p>

In order to:	You must ⇒ <a href="#">fig. 272</a> :	Result:
	Push and hold the lever <i>longer</i> in the <b>SPEED</b> – position (5) to reduce the set speed continuously until the lower desired speed is reached and the lever is released.	
Switch off ACC.	Push the lever to <b>OFF</b> position (4).	The system is switched off and the stored speed is canceled.

When you push the lever ⇒ [fig. 272](#) briefly to **SPEED** + position (2), the speed will be increased first to the next highest value in increments of 5 mph (10 km/h), like from 47 mph (76 km/h) to 50 mph (80 km/h). Only after that it is possible to increase the speed in increments of 5 mph (10 km/h) by *briefly* pushing the lever to the **SPEED** + position (2).

ACC works in the same way when reducing the set speed.

#### Requirements for activating ACC

- Lever is in the **ON** (1) position.
- The selector lever must be in **D**, **S** or in Tiptronic mode.
- Gradient angles can't be more than +/- 19 %.
- Brake pedal is depressed when vehicle is standing still.
- the driver safety belt is fastened.
- The doors and the engine hood are closed.
- The electronic parking brake is released
- Hill Descent Assist is not activated.
- The vehicle is not rolling backwards.
- There is no parked vehicle or other object in front of your moving vehicle.

#### Activating ACC

When ACC is active one of the 2 green indicator lights (☺ or ☺) light up and the set speed is shown in the display of the instrument cluster and indicated by red dots on the speedometer. Text messages and indicator lights in the instrument cluster inform you about the status of the system ⇒ page 459.

When ACC is switched, activated and properly working, it will store and regulate the desired speed. The set speed can vary from the actually driven speed if ACC is regulating the distance to the vehicle travelling ahead.

#### Decelerating to a stop

If a vehicle ahead decelerates to a stop the Adaptive Cruise Control likewise decelerates your vehicle to a standstill. After this vehicle is kept in place by the brakes.

In this state using the brake does not deactivate the Adaptive Cruise Control.

If you unlock the safety belt, open the a door or the engine hood, switch off the ignition during such a braking state or if the stop exceeds about three minutes, the Adaptive Cruise Control switches off temporarily and activates the parking brake.

By depressing the gas pedal while the vehicle is standing still and ACC is active, the vehicle will accelerate. Once you take your foot off the pedal, ACC will automatically resume the stored speed and regulate the set distance.

ACC will **not** automatically accelerate if the vehicle ahead accelerates.

**Distance (time interval) to the vehicle ahead and driving profiles**

The distance the ACC maintains to the vehicle traveling ahead is determined by *time intervals*. A time distance to the vehicle traveling ahead is maintained. This results in a speed-dependent distance. The higher the speed, the larger the distance in feet/meters ⇒ ⚠.

The distance can be set at 4 different levels:

Distance	Time distance at 65 mph (105 km/h)
Very small	about 1,0 Seconds
Small	about 1,3 Seconds
Medium	about 1,8 Seconds
Large	about 2,5 Seconds

Besides changing the time distance, the acceleration characteristics can be changed, by choosing on of the following driving profiles:

- Comfort
- Normal
- Sport

The distance intervals can be set by pushing the slider switch on the lever ⇒ [fig. 273](#). The driving profile can only be set in the infotainment system .

Always select a greater following distance to the vehicle ahead on wet roads than on dry roads.

**Setting the distance and selecting a driving profile**

In order to show the currently selected distance in the instrument cluster display, briefly tap the sliding switch on the lever ⇒ [fig. 273](#).

Setting the distance with the sliding switch on the lever ⇒ [fig. 273](#):

In order to:	You must ⇒ <a href="#">fig. 273</a> :	Result:
Increase the distance by one level	Briefly push the sliding switch to the right (+).	The distance is increased by 1 level.

In order to:	You must ⇒ fig. 273:	Result:
Increase the distance quickly	Push and hold the sliding switch to the right (+).	The distance is increased quickly by several levels.
Decrease the distance by one level	Briefly push the sliding switch to the left (-).	The distance is decreased by 1 level.
Decrease the distance quickly	Push and hold the sliding switch to the left (-).	The distance is decreased quickly by several levels.

Selecting a driving profile in the infotainment system:

- Switch on the ignition.
- Push the infotainment button **CAR**.
- Tap on the **Assistants** button in the display.
- Select **ACC**.
- Tap on the **Driving profiles** button in the display and select driving profile.

### DANGER

**Following other vehicles too closely increases the risk of collisions and serious personal injury or even death.**

- **Always obey applicable traffic laws when setting the distance to the vehicles ahead in traffic.**
- **Setting short distances to the traffic ahead reduces the time and distance available to bring your vehicle to a safe stop and makes it even more necessary to pay close attention or traffic.**
- **Always use good judgment and select a safe following distance for the traffic, road and weather conditions.**
- **Never use Adaptive Cruise Control on narrow or winding roads or under poor road conditions (snow, ice, streets covered with standing water or gravel, for example) or when visibility is poor, especially when it is foggy.**
- **Always select a greater following distance to the vehicle ahead on wet roads than on dry roads.**

## WARNING

Improper use of the Adaptive Cruise Control can cause collisions, other accidents and serious personal injury.

- Always remember that the Adaptive Cruise Control has limits – it will not slow the vehicle down or maintain the set distance when you drive towards an obstacle or something on or near the road that is not moving, such as vehicles stopped in a traffic jam, a stalled or disabled vehicle.
- Always remember that the Adaptive Cruise Control cannot detect a vehicle that is driving towards you in your traffic lane and that it cannot detect narrow vehicles such as motorcycles and bicycles.
- Never drive at speeds that are too fast for traffic, road and weather conditions.
- Never follow a vehicle so closely that you cannot stop your vehicle safely. The Adaptive Cruise Control cannot slow or brake the vehicle safely when you follow another vehicle too closely. Always remember that the Adaptive Cruise Control has a braking power that is only about 30% of the vehicle's maximum braking ability, the automatic braking function cannot bring the vehicle to a stop.
- Never use Adaptive Cruise Control when you cannot drive safely at a steady speed, including on city streets, on winding roads or when road conditions are poor (for example, on ice, gravel, in fog, heavy rain or on wet roads that increase the risk of hydroplaning).
- The radar sensor's *vision* can be reduced by rain, snow and heavy road spray. These and similar conditions can prevent vehicles up ahead from being accurately detected and in some cases they may not be detected at all. Do not use ACC when the radar sensors cannot accurately detect vehicles moving ahead of you in traffic.
- Always turn off Adaptive Cruise Control when entering turn lanes, exit lanes and construction zones or in similar situations because the vehicle will automatically accelerate to the stored speed when the road ahead is clear.
- Never rest your foot on the accelerator pedal, especially when the Adaptive Cruise Control is being used because doing so will override the braking function.
- Always pay attention to traffic, especially when Adaptive Cruise Control is switched on.
- Always maintain a safe speed and distance between your vehicle and other vehicles while considering the traffic situation. This is the duty of the driver. Adaptive Cruise Control is merely an aid to the driver.
- To prevent unintended operation, always switch ACC off when it is not being used.
- It is dangerous to use the "Resume" feature when the previously set speed is too high for existing road, traffic or weather conditions.
- Always select a speed and distance to traffic ahead that is safe and appropriate under the prevailing traffic, road, weather and lighting conditions.
- Never allow the closing speed between you and other vehicles to be so high that the Adaptive Cruise Control may not be able to slow your vehicle safely. If closing speed is too high, you must apply the brakes yourself to reduce the risk of a rear-end crash.

## NOTICE

When the vehicle is driving at speeds lower than 20 mph (30 km/h) and the **SET** button is pressed or the lever is moved to **RESUME**, the vehicle will be accelerated to the lowest possible speed that can be set in ACC of 20 mph (30 km/h)

 The stored speed is canceled when the ignition or the ACC is switched off.



 The Electronic Stabilization Program (ESC) cannot be deactivated when the Adaptive Cruise Control is switched on. If the ESC has been deactivated and you then switch on the Adaptive Cruise Control, the ESC function will also be activated automatically.

 The currently set distance and the last settings are stored automatically and assigned to the used remote control vehicle key.

## When to temporarily deactivate Adaptive Cruise Control (ACC)

 Please first read and note the introductory information and heed the WARNINGS 

Please deactivate ACC under following conditions ⇒ :

- When driving around curves, turn lanes, highway ramps or construction sites, in order to prevent unwanted acceleration of the vehicle.
- When driving through tunnels.
- Under bad weather conditions or bad visibility, like in heavy rain, snowfall or fog.

 **WARNING**  
Not deactivating Adaptive Cruise Control (ACC) in the situations mentioned above can cause collisions, other accidents and serious personal injury.

## Forward Collision Warning system (Front Assist)



Fig. 274 In the instrument cluster display. Advance warning: Distance to vehicle ahead becoming too small.

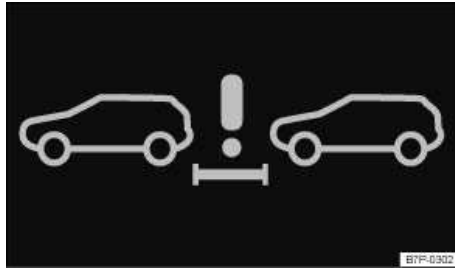

**Fig. 275** In the instrument cluster display. Alert: Distance to vehicle ahead is too small.

**ⓘ Please first read and note the introductory information and heed the WARNINGS ⚠**

The Forward Collision Warning system (Front Assist), when switched on, uses a radar sensor to help prevent rear-end collisions by providing a warning of a possible collision with a vehicle on the road ahead within physical and technical limits of the system.

**The Forward Collision Warning system (Front Assist) is not a substitute for the driver's full concentration.**

**Distance warning**

If the vehicle is traveling within a speed range of about 44–130 mph (70–210 km/h), the system warns the driver with a message in the instrument cluster display ⇒ [fig. 275](#) if it detects that the vehicle is driving too close to the vehicle ahead ⇒ ⚠.

The warning period varies according to the traffic situation and your driving style.

**Advance warning**

If the vehicle is traveling within a speed range of about 18–130 mph (30–210 km/h), the system warns the driver with a warning chime and a message in the instrument cluster display (⇒ [fig. 274](#)) if it detects a possible collision with a vehicle ahead ⇒ ⚠.

The warning period varies according to the traffic situation and your driving style.

However, do not rely solely on Front Assist. Under certain conditions, the reactions of Front Assist may be unexpected or delayed from the driver's viewpoint. Always pay attention and take over if necessary ⇒ ⚠.

**Immediate warning**

Front Assist can initiate a short active braking maneuver, should you not react accordingly to an advance alert. In this case you will notice brief jerky braking of the vehicle, in order to warn you of an impending collision.

The moment of this alert can vary, depending on the traffic situation and the driving behavior.

**Automatic braking maneuver**

If you should also fail to react to the immediate alert, the system can initiate an automatic braking maneuver which will slow down the vehicle with gradually increasing braking force. Shortly before a collision the system can also initiate an emergency braking in order to bring the vehicle to a full stop. The reduction of speed can help to minimize the effects of a collision.

**Braking support**

Front Assist can help to minimize the effects of a collision by supporting with additional braking force in case of an emergency braking situation, should the system detect that the force applied to the brake pedal by the driver is not sufficient in order to avoid a collision. In order for Front Assist to apply this support, it must have detected an impending collision with another vehicle ahead of yours and the

brake pedal has to be hit hard and suddenly. However, this support only works as long as the brake pedal is depressed.

Front Assist cannot react when approaching standing objects ahead of you, like when driving up to a line of stopped vehicles in heavy traffic.

### Operating Front Assist

Front Assist can be turned off or on in the infotainment system:

- Switch on the ignition.
- Push the infotainment button **CAR**.
- Tap on the **Assistants** button in the display.
- Select **Front Assist**.
- Tap on the **Active** button in order to switch Front Assist on or off.

If the box next to the **Active** button is checked , then Front Assist is active and ready.

If Front Assist is switched off, then the message **Front Assist deactivated** appears in the display of the instrument cluster.

With Front Assist switched off, the advance alert and the distance alert are also deactivated.

### Switching the advance alert and distance alert on and off

The advance alert and distance alert can be activated or deactivated together in the infotainment system:

- Switch on the ignition.
- Push the infotainment button **CAR**.
- Tap on the **Assistants** button in the display.
- Select **Front Assist**.
- Tap on the **Alert** button in order to switch advance alert and distance alert on or off.

If the box next to the **Active** button is checked , then advance alert and distance alert are active and ready.

Volkswagen recommends to always leave the advance alert and distance alert activated.

### Special driving situations

Front Assist is subject to physical and system-specified limits when driving. Under certain conditions, the reactions of the Adaptive Cruise Control may be unexpected or delayed from the driver's viewpoint

## WARNING

The Forward Collision Warning system (Front Assist) technology cannot overcome the laws of physics and system-related limits. The driver is always responsible for braking in time. If the Forward Collision Warning system issues a warning, immediately apply the brake to slow the vehicle down or avoid the obstacle, depending on the traffic situation.

- Always adjust your speed and driving style to road, traffic, weather, and visibility conditions.
- The Forward Collision Warning system cannot prevent accidents and serious injuries on its own.
- The Forward Collision Warning system can issue unnecessary warnings in certain complex driving situations, for example, at traffic islands.
- The Forward Collision Warning system can issue unnecessary warnings when its function is impaired, for example, if the radar sensor is dirty or if the position of the radar sensor has been changed.
- The Forward Collision Warning system does not react to people, animals, or vehicles crossing or approaching in the same lane.
- Always be prepared to take full control of the vehicle at all times.

## NOTICE

If you notice that the Forward Collision Warning system (Front Assist) doesn't work properly or the sensors are damaged, switch off the Forward Collision Warning system (Front Assist) immediately.

- Go see an authorized Volkswagen dealer or Volkswagen Service Facility for assistance and have the Forward Collision Warning system (Front Assist) checked.



If the Forward Collision Warning system (Front Assist) initiates a braking maneuver, the hydraulic braking system is under pressure. In this case the braking pedal will feel "harder" and the brake pedal travel will be shorter.



Automatic braking maneuvers can be interrupted by depressing the gas pedal or moving the steering wheel.



Deactivate the Forward Collision Warning system if it does not work as described in this chapter, for example, if multiple unwanted warnings occur. Have the system checked by an authorized Volkswagen dealer or authorized Volkswagen Service Facility.

## Temporarily switch off the Forward Collision Warning system (Front Assist) in the following situations

 Please first read and note the introductory information and heed the WARNINGS 

The Forward Collision Warning system (Front Assist) should be switched off in the following situations due to system limitations ⇒ :

- If the vehicle is being towed.
- If the vehicle is on a dynamometer test bed.
- If the vehicle is not being driven on public roads, for example, off-road or on a track.

- If the radar sensor malfunctions.
- If external force has affected the radar sensor, for example, after a rear-end collision.
- If the radar sensor is covered (even temporarily) by any accessories or other equipment, for example, auxiliary headlights.
- If the vehicle is being loaded onto a truck, ferry, or train.



## WARNING

Failure to switch off the Forward Collision Warning system in the situations mentioned can cause accidents and serious personal injury.

## Forward Collision Warning system (Front Assist) system limits

 Please first read and note the introductory information and heed the WARNINGS 

The Forward Collision Warning system (Front Assist) has physical and system-related limits. The driver may therefore feel that, in certain circumstances, some Forward Collision Warning system reactions are unwanted or occur with a delay. You should therefore always be prepared to take full control of the vehicle whenever necessary.

**The following conditions can prevent the Forward Collision Warning system (Front Assist) from reacting, or delay its ability to react:**

- When driving in tight curves.
- When the accelerator pedal is depressed.
- When the Forward Collision Warning system (Front Assist) is switched off or if there is a fault.
- When ASR is manually switched off.
- When the ESC is taking corrective action.
- When several brake lights on the vehicle or on a trailer connected to the vehicle electrical system are faulty.
- When the radar sensor is dirty or covered.
- When there are metal objects, for example, tracks or metal plates in the road.
- When the vehicle is in Reverse (**R**).
- When weather conditions are poor.
- When narrow vehicles, such as motorcycles, are moving in front of your vehicle.
- When vehicles are traveling slightly offset to the left or right in front of your vehicle.
- When vehicles are crossing in front of your vehicle.
- When there is oncoming traffic.
- When the system cannot detect the traffic situation clearly.
- When loads or attachment parts on other vehicles in front of your vehicle protrude to the side, rear, or above the normal vehicle dimensions.

## Autonomous Emergency Braking

---



Fig. 276 In the instrument cluster display. Warning: Distance to vehicle ahead becoming too small.

**ⓘ Please first read and note the introductory information and heed the WARNINGS ⚠**

Autonomous Emergency Braking is a function of the Forward Collision Warning system (Front Assist) and active when the Forward Collision Warning system (Front Assist) is switched on.

The Autonomous Emergency Braking function monitors the traffic situation in front of your vehicle at speeds between 3 mph (5 km/h) and about 20 mph (30 km/h).

If the Autonomous Emergency Braking function detects a critical situation which can lead to a collision, it will prepare the vehicle for a possible emergency braking maneuver ⇒ ⚠.

In case of an impending collision and the driver not reacting accordingly to the warning, the system can initiate an automatic braking maneuver in order to reduce the speed of your vehicle and help minimize the effects of a collision.

### Display

An automatic braking maneuver is indicated by a warning in the instrument cluster display ⇒ fig. 276.

**The Autonomous Emergency Braking function may not work under following conditions:**

- When driving around curves.
- When the Forward Collision Warning system (Front Assist) is switched off or not working properly.
- When ASR is switched off manually.
- When ESC is actively regulating.
- When 2 or more brake lights on your vehicle are not working.
- When the sensors are soiled or covered.
- When the brake pedal is depressed.
- When the **OFF-ROAD** mode is switched on.
- If the last braking maneuver initiated by the Autonomous Emergency Braking function is shorter than 20 seconds ago.
- When your vehicle is driving in reverse.
- When your vehicle is quickly accelerated.
- In bad weather conditions with decreased visibility, like heavy rain or snowfall.
- If the vehicles travelling ahead are too small or narrow, like motorcycles or bicycles.
- If the vehicles travelling ahead are driving offset.
- If the radar sensor signal is multiply reflected, like when driving in parking garages.
- In case of crossing traffic.
- In case of oncoming vehicles on your lane.

**The Autonomous Emergency Braking function should be deactivated by switching off the Forward Collision Warning system (Front Assist) in following situations:**

- When the vehicle is being towed.
- When the vehicle is on a roller test stand.
- When the vehicle is off road, like on construction sites or on race tracks.
- When one of the sensors is defect.
- When the sensors have been damaged, like after a frontal collision accident.
- After several false alarms in a row.
- If the sensors are covered by additional parts, like auxiliary headlights.
- If the vehicle is driving on steep terrain or on or across slopes.



**WARNING**

**Always remember that the Autonomous Emergency Braking function has limits – it will not release you from the responsibility to control and slow down your vehicle.**

- **The Autonomous Emergency Braking function alone cannot avoid accidents and fatal injuries.**
- **Under certain circumstances and complex traffic situations the Autonomous Emergency Braking function can perform unwanted braking maneuvers, like in construction sites.**
- **Soiled or misaligned radar sensors can lead to unwanted braking maneuvers**
- **The Autonomous Emergency Braking function does not react to people, animals, crossing traffic or vehicles that are approaching you on the same lane.**
- **Always adjust your speed and the distance you keep between you and the vehicles ahead of you to the road, traffic, weather, and visibility conditions.**
- **Never follow a vehicle so closely that you cannot stop your vehicle safely, under certain circumstances the automatic braking function cannot bring the vehicle to a stop in time.**
- **Never allow the closing speed between you and other vehicles to be so high that the Autonomous Emergency Braking function may not be able to slow your vehicle safely. If closing speed is too high, you must apply the brakes yourself to reduce the risk of a rear-end crash.**
- **Always be prepared to takeover the control of the brake and the gas pedal in every situation.**



**NOTICE**

**If you notice that the Autonomous Emergency Braking function doesn't work properly or the sensors are damaged, switch off the Forward Collision Warning system (Front Assist) and therefore the Autonomous Emergency Braking function immediately.**

- **Go see an authorized Volkswagen dealer or Volkswagen Service Facility for assistance and have the system checked.**



If the Autonomous Emergency Braking function initiates a braking maneuver, the hydraulic braking system is under pressure. In this case the braking pedal will feel "harder" and the brake pedal travel will be shorter.



Automatic braking maneuvers can be interrupted by depressing the gas pedal or moving the steering wheel.



The Autonomous Emergency Braking function can slow your vehicle down to a standstill, but not hold your vehicle permanently. When necessary, apply the vehicle brakes!

 Should the Autonomous Emergency Braking function not work properly as described here and initiate several false alarms unwanted braking maneuvers in a row, temporarily deactivate the Forward Collision Warning system (Front Assist) and therefore the Autonomous Emergency Braking function. Have the system checked by an authorized Volkswagen dealer or Volkswagen Service Facility.

## Special driving situations

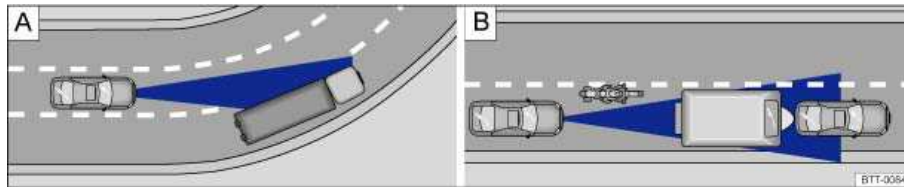

Fig. 277  Driving in a curve.  Motorcycle travelling ahead outside of the sensor range.

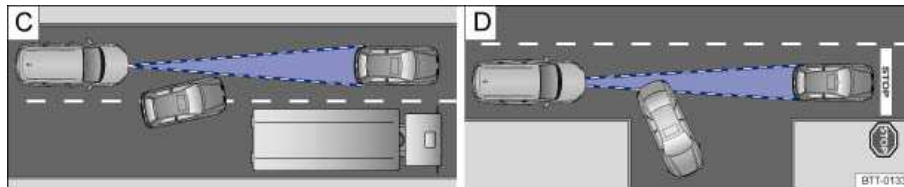

Fig. 278  Vehicle changing lanes.  A turning and a stationary vehicle ahead.

 Please first read and note the introductory information and heed the WARNINGS 

Adaptive Cruise Control is subject to physical and system-specified limits when driving. Under certain conditions, the reactions of the Adaptive Cruise Control may be unexpected or delayed from the driver's viewpoint. Always pay attention and take over if necessary:

### Changing lanes and passing other vehicles

When you change lanes, like when passing a vehicle ahead of you, and there is no other vehicle detected on the lane that you switched to, ACC will automatically accelerate your vehicle to the previously set speed.

### Driving around curves and roundabouts

When driving into a curve and driving out of a long curve, the radar sensor may react to a vehicle in the next lane  $\Rightarrow$  fig. 277 (A) and cause your vehicle to brake. You stop the braking process by pressing the accelerator pedal.

When driving in curves and roundabouts it can happen that the vehicle travelling ahead of yours temporarily leaves the sensor range of your vehicle. This can lead to an unwanted acceleration of your vehicle. Switch off ACC in narrow curves and roundabouts.

### Driving through tunnels

The function of the distance radar may be limited when driving in tunnels. Switch off ACC when driving through tunnels.

### Vehicles offset to one side

Vehicles traveling ahead and to one side can only be detected by the radar sensor when they are within sensor range (B). That applies especially to narrow vehicles such as motorcycles.



### Vehicles with oversize loads

Under certain circumstances vehicles carrying oversize loads or loads that exceed the vehicle dimensions, like flat-bed trailer trucks, can't be recognized correctly by the ACC. Switch off ACC when driving behind such vehicles.

### Other vehicles changing lanes

Vehicles that change into your lane within a short distance can only be detected by the radar sensor once they are within sensor range ⇒ [fig. 278 \(C\)](#). The result is a delayed reaction by the Adaptive Cruise Control.

### Stationary vehicles

If a vehicle detected by Adaptive Cruise Control turns or changes lanes and there is a stationary vehicle in front of that vehicle, the system will not react to the stationary vehicle [\(D\)](#).

### Narrow vehicles

Narrow vehicles, such as motorcycles traveling ahead, are often detected late or not at all under some circumstances.

### Oncoming vehicles

ACC does not detect oncoming vehicles on your lane.

### Metal objects on the road

Metal objects on the road, such as tracks, can cause irritations for the ACC due to falsely reflected radar signals and therefore lead to unwanted reactions of the system, such as abrupt braking maneuvers.

### Radar sensor impaired by rain and dirt

If the radar sensor function is impaired by heavy rain, spray, snow or mud, Adaptive Cruise Control switches off temporarily. **ACC not available. No sensor view!** appears in the instrument cluster display.

When Adaptive Cruise Control is reactivated after this message is displayed, it functions like a "standard" cruise control system. It maintains the set speed but it does **not** regulate the distance to the vehicle ahead.

### Overheated brakes

Adaptive Cruise Control may switch off temporarily if the brakes overheat significantly, for example from braking maneuvers or driving down steep slopes. **ACC not available** appears in the instrument cluster display. Adaptive Cruise Control cannot be activated.

Adaptive Cruise Control can be activated again once the temperature of the brakes decreases sufficiently. The message **ACC not available** in the instrument cluster switches off.

If the message **ACC not available** does not switch off, there is a malfunction. Contact your authorized Volkswagen dealer.

### Trailer towing

When towing a trailer, ACC and the Forward Collision Warning system (Front Assist) may work only with limited functionality.

### Text messages in the instrument cluster display

Text message	Meaning
--------------	---------

Text message	Meaning
ACC not available.	ACC and/or the Forward Collision Warning system (Front Assist) are disabled due to a system malfunction or soiled/misaligned sensors.
ACC and Front Assist are not available.	
ACC not available. No sensor view!	The sensors are soiled and the sensor view is impaired. Clean the sensors.
ACC and Front Assist are not available. No sensor view!	
ACC is currently not available. Gradient is too large.	The highest possible gradient of 19% for ACC to work properly is exceeded or the vehicle is rolling backwards. ACC is deactivated.
ACC is only available in driving level D, S or M.	Shift to selector lever position <b>D</b> , <b>S</b> or <b>M</b> (Tiptronic mode).
ACC: Release parking brake!	ACC is deactivated when the electronic parking brake is engaged.
ACC is currently not available. HDC activated.	The <i>OFF-ROAD mode</i> is switched on and the Hill descent assist is activated. ACC is deactivated automatically. In order to enable ACC, switch off the <i>OFF-ROAD mode</i> .
ACC: Stabilization control (ESC) intervention.	The Electronic Stabilization Control (ESC) is currently working and ACC is temporarily deactivated.

Text message	Meaning
ACC: Not available. Please manually accelerate and brake.	ACC is not available. Driver intervention is necessary.
Door open.	ACC cannot be activated. Please close all doors and engine hood.
Object ahead.	A stationary object is detected ahead when ACC is switched on and your vehicle is moving. ACC cannot be activated.
Front Assist deactivated.	Front Assist is deactivated.



### WARNING

The view of the radar sensor can be impaired by rain, snow or heavy spray. Under certain circumstances, this could result in the vehicle ahead being detected inadequately or not at all. Take over yourself if necessary!

- Switch Adaptive Cruise Control off when driving through tunnels because the function of the system could be impaired.
- 
- Adaptive Cruise Control distance regulation will not work if the sensors are covered by heavy rain, spray, snow, etc. ACC not available. No sensor view! appears in the instrument cluster display.
- Adaptive Cruise Control switches off temporarily if the brakes overheat too much. ACC not available appears in the instrument cluster display.

# Lane Assist

## Introduction

---

In this section you'll find information about:

- Warning and Indicator lights
- How Lane Assist works
- When to deactivate Lane Assist
- Driver information
- Settings

The Lane Assist system can warn you if your vehicle unintentionally leaves the current drive lane.

Any settings for Lane Assist in the infotainment system as well as the activation or deactivation of the system will be stored after the ignition is switched off and will be kept after the ignition is switched back on again.

When you change Lane Assist settings you will notice a short vibration in the steering wheel as a confirmation that the new settings are stored.

Lane Assist has been developed only for on-road driving.

### More information:

- Exterior views
- Parts, accessories, repairs and modifications
- Volkswagen Information System

### WARNING

Always remember that Lane Assist has limits – Using Lane Assist when it is not possible to drive safely can be dangerous and can lead to an accident and serious personal injury.

- Always adjust your speed and the distance you keep between you and the vehicles ahead of you to the road, traffic, weather, and visibility conditions.
- Always keep your hands on the steering wheel and be ready react - Lane Assist will not release you from the responsibility to control your vehicle.
- Always pay attention to the messages in the instrument cluster display and act accordingly.
- Always pay close attention to what is happening around your vehicle.

### WARNING

Under certain circumstances the Forward Collision Warning system (Front Assist) may not be able to recognize all lane markings. Bad or wet roads, worn out markings or objects on the road can lead to the Forward Collision Warning system (Front Assist) not or mistakenly recognizing lane markings.

- Always switch off Lane Assist under these conditions.



## WARNING

If the view area of the camera is covered or dirty, Lane Assist may not work properly.

- Always make sure that the camera area is free of dirt or snow and not covered.



## NOTICE

In order to help maintain the proper function of the Forward Collision Warning system (Front Assist):

- Always keep the camera area in the front windshield free of ice, dirt and snow.
- Never cover the camera area.
- Regularly check the windshield and especially the area of the camera for damages.



Lane Assist has been developed only for on-road driving.



If Lane Assist does not work properly and as described here, have the system checked by an authorized Volkswagen dealer or Volkswagen Service Facility.

## Warning and Indicator lights

☑ Please first read and note the introductory information and heed the WARNINGS ⚠

lights up	Possible cause	Proper response
	System or camera malfunction.	Switch the ignition off and on again. Should the warning light still light up, have the system checked by an authorized Volkswagen dealer or Volkswagen service facility.
	Camera view area is covered.	Clean the area of the camera ⇒ <a href="#">fig. 279</a> .
	Lane Assist is switched on and ready.	-
	Lane Assist is switched on but not active.	System is switched on, but can't recognize any lane markings.

lights up	Possible cause	Proper response
		Minimum speed not yet reached.

When the ignition is switched on, several warning and indicator lights come on briefly for a function check. They go out after a few seconds.

### **WARNING**

Failure to heed warning lights and instrument cluster text messages can cause the vehicle to break down in traffic and result in a collision and serious personal injury.

- Never ignore warning lights or text WARNINGS.
- Always stop the vehicle as soon as it is safe to do so.

### **NOTICE**

Failure to heed warning lights or text WARNINGS can result in vehicle damage.

## How Lane Assist works

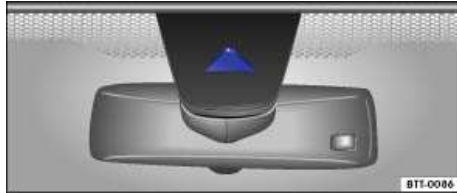

Fig. 279 In the front windshield: Area of the Lane Assist camera.

 Please first read and note the introductory information and heed the WARNINGS 

With the help of a camera → fig. 279, Lane Assist can recognize possible side markings of the current drive lane. Should the vehicle leave this area unintentionally, like when leaving the current drive lane without activating a turn signal, the system will warn you by a *vibration of the steering wheel*.

Lane Assist is ready when it recognizes at least *one* side marking.

Lane Assist will not warn you of a lane change if you activate the turn signal, since the system will assume that the lane change is happening intentionally.

### Switching Lane Assist on and off

Select **Assistants** from the main menu in the instrument cluster, then select  **Lane Assist**.

If the check box in the instrument cluster menu is activated () , Lane Assist is automatically enabled when the ignition is switched on.

The indicator light in the instrument cluster shows the status of the system.

The stored settings are recalled when the ignition is switched on.

 Before starting to drive, always make sure that the area of the camera ⇒ [fig. 279](#) is not covered.

## When to deactivate Lane Assist

---

 Please first read and note the introductory information and heed the **WARNINGS** 

Please deactivate Lane Assist under following conditions ⇒ 

- In complex traffic situations when it is necessary for the driver to pay special attention.
- On bad roads or on roads with no or hardly visible side markings.
- Under bad weather conditions and/or bad visibility.
- When the vehicle is off road, like on construction sites or on race tracks.
- If the camera is covered by dirt, ice or snow. In this case clean the camera area as soon as possible or deactivate the system.

 <b>WARNING</b>
<b>Not deactivating Lane Assist in the situations mentioned above can cause collisions, other accidents and serious personal injury.</b>

## Driver information

---

 Please first read and note the introductory information and heed the **WARNINGS** 

### Automatic deactivation of Lane Assist

Under certain circumstances Lane Assist can be deactivated automatically:

- If the system cannot recognize side markings correctly, like in construction sites, on bad roads, bad visibility or when the camera area is covered.
- If more than 2 side markings are on the lane, like in certain construction sites or when markings have been added to the lane.
- When the speed of your vehicle is less than 40 mph (65 km/h).
- In narrow curves.
- When a turn signal or the emergency flashers are activated.
- If ESC is deactivated and the warning light  appears in the instrument cluster display

An automatic deactivation of Lane Assist is indicated by a change of color from *green* to *grey* of the indicator light  in the instrument cluster display.

 In order to avoid several warnings in a row, it can happen that Lane Assist warns you when leaving a lane by crossing over a side marking, but wouldn't warn a second time after crossing a second marking shortly after. this is normal and no cause for concern.

## Settings

---

 Please first read and note the introductory information and heed the **WARNINGS** 

## Lane Assist settings in the infotainment system

You can change some Lane Assist settings in the infotainment system

- Switch on the ignition.
- Push the infotainment button **CAR**.
- Tap on the **Assistants** button in the display.
- Select **Front LaneAssist**.

---

### Function key

---

**Warning time setting**: After touching the **Warning time setting** or  function key, you can choose between *early*, *medium* and *late*.

**Steering wheel vibration**: After touching the **Steering wheel vibration** or  function key, you can choose between *low*, *medium* and *strong*.

---

### Setting the warning time

Menu option	Meaning
<i>Early</i>	The system has a low tolerance level and warns you early if you come too close to a side marking.
<i>Medium</i>	Original setting.
<i>Late</i>	The system has a high tolerance level and warns you late if you come too close to a side marking.

The warning time setting defines the distance from your vehicle to the side markings. An early warning time means that the distance to the side markings has to be high in order for Lane Assist **not** to trigger a warning.

The time of the warning is also dependent on the approach angle to the side marking and the driving speed. If, for example, you approach a road marking at a steeper angle, the steering wheel will start vibrating at a greater distance.

### Setting the vibration level of the steering wheel

Menu option	Meaning
<i>Low</i>	Light vibration of the steering wheel.



<b>Menu option</b>	<b>Meaning</b>
<i>Medium</i>	Original setting.
<i>Strong</i>	Intensive vibration of the steering wheel.

 The factory settings of the warning time and the vibration level are set to *Medium*.

# Side Assist

## Introduction

---

In this section you'll find information about:

- Warning and indicator lights
- How Side Assist works
- Driving with Side Assist
- Operating Side Assist

Depending on vehicle equipment, the vehicle may be equipped with the Side Assist system.

The Side Assist system can support the driver watch out for traffic next to and behind the vehicle.

The Side Assist system has been developed only for on-road driving.

A Declaration of Compliance with the United States FCC and Industry Canada regulations is found on  
⇒ *Declaration of Compliance, Telecommunications and Electronic Systems.*

### More information:

- Exterior views
- Volkswagen Information System
- Trailer towing
- Parts, accessories, repairs, and modifications
- Consumer information

### WARNING

- Side Assist technology cannot overcome the laws of physics and the limits of the system. Careless or unintentional use of Side Assist may result in accidents and severe injuries.
- Always adjust your speed and driving style to road, traffic, weather, and visibility conditions.
- Always keep your hands on the steering wheel and be prepared to steer.
- Pay attention to the indicator lights in the outside mirrors and in the display of the instrument cluster and operate accordingly.
- Always be careful and look around you. The sensors cannot always detect people, animals, objects. Watch out for small children and animals in particular.



### NOTICE

- The sensors above the rear bumper can be damaged or become misaligned in low speed impacts and parking maneuvers. Damaged or misaligned sensors cannot accurately detect or report objects that might be within range of the Side Assist system.
- When cleaning the sensors with power washers or steam cleaners, only spray the sensors directly for a very short time, and always keep the washer nozzle at least 4 inches (10 cm) from the sensors.
- To help make sure that the system works properly, always keep the sensors in the bumpers clean and free of snow and ice; do not cover the sensors with stickers or other objects.

## Warning and indicator lights

☐ Please first read and note the introductory information and heed the WARNINGS ⚠

### Indicator light in the instrument cluster

Lights up	Possible cause	Proper response
	Side Assist system or sensor malfunction	Switch the ignition off and on again. Should the warning light still light up, have the system checked by an authorized Volkswagen dealer or Volkswagen service facility.
	Side Assist is activated.	-
	Side Assist is switched on but not active. Vehicle speed is too low.	If applicable, accelerate vehicle to at least 20 mph (30 km/h)

When the ignition is switched on, several warning and indicator lights come on briefly for a function check. They go out after a few seconds.

### Indicator lights in the outside mirrors

Light up	Possible cause
	Light up briefly: Side Assist is switched on and ready.
	Light up: Side Assist detected another vehicle next to or diagonally behind your vehicle.

Light up and flash	Possible cause
	The turn signal is switched on and Side Assist detected another vehicle on the corresponding side of your vehicle ⇒ ⚠.

If no other vehicle is detected by the Side Assist system in the critical area of your vehicle, the indicator lights in the outside mirrors will not light up ⇒ ⚠.

The closer the detected vehicle is to your vehicle, the more indicator lights light up in the outside mirrors. If the approaching vehicle is very close, 4 indicator lights light up.

### ⚠ WARNING

Failure to heed warning lights and instrument cluster text messages can cause the vehicle to break down in traffic and result in a collision and serious personal injury.

- Never ignore warning lights or text WARNINGS.
- Always stop the vehicle as soon as it is safe to do so.

### ! NOTICE

Failure to heed warning lights or text WARNINGS can result in vehicle damage.

## How Side Assist works

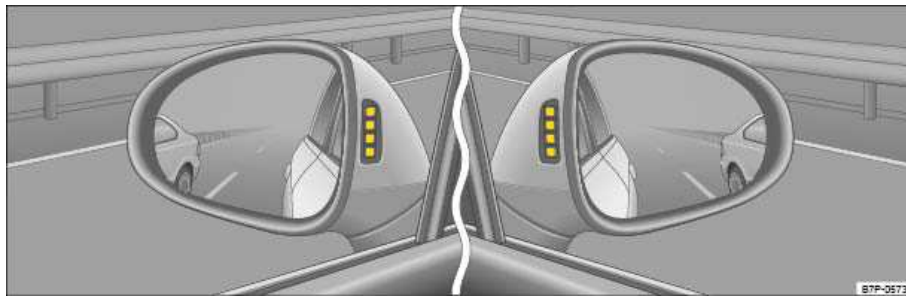

Fig. 280 In the outside mirrors: Side Assist indicator lights



Fig. 281 Rear view of the vehicle: Areas of the Side Assist radar sensors.

⚠ Please first read and note the introductory information and heed the WARNINGS ⚠

Side assist monitors the area next to and behind your vehicle with the help of radar sensors. The system measures the distance and the speed difference to the other vehicles around you. Side Assist

does not work below speeds of about 20 mph (30 km/h). If Side Assist detects one or more vehicles in the monitored area, indicator lights light up in the outside mirrors.

#### Indicator lights in the outside mirrors

The indicator lights ⇒ [fig. 280](#) in the outside mirrors inform you about the traffic behind your vehicle.

The indicator lights in the left outside mirror ⇒ [fig. 280](#) inform you about traffic on the left side and the indicator lights in the right outside mirror ⇒ [fig. 280](#) inform you about the traffic on the right side of your vehicle.

Indicator lights in the outside mirror	Possible cause
Stay off.	No other vehicle detected by Side Assist in the critical area of your vehicle.
Light up briefly once.	Side Assist is switched on and is ready.
Light up.	Side Assist detected a possible critical situation.
Repeatedly light up brightly.	The turn signal is switched on and Side Assist detected a possible critical situation on the corresponding vehicle side ⇒  in <i>Warning and indicator lights</i>

#### Radar sensors

The Side Assist radar sensors are located on the left and right side above the rear bumper ⇒ [fig. 281](#). They cover an area of about 50 m (160 ft) behind your vehicle as well as the blind spots on the left and right vehicle side. On the left and right side of your vehicle Side Assist covers an area of about the width of one driving lane.

However, Side Assist does not recognize the exact width of the driving lanes next to your vehicle. In some cases, such as driving in the middle of 2 lanes or with very narrow lanes, this can lead to an incorrect indication. In other cases, vehicles moving on further driving lanes like the second to left lane, or even fixed objects, such as guide rails, can cause the indicator lights to light up.

## Driving with Side Assist

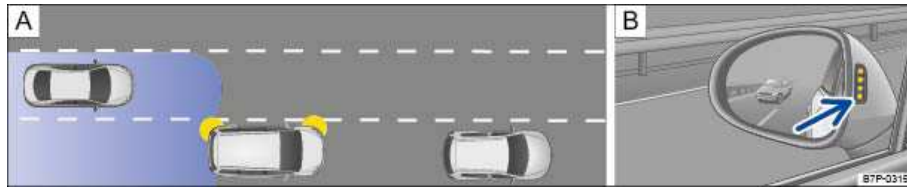

**Fig. 282** Driving with Side Assist: A: Moving to another lane with rear traffic. B: Side Assist indicator lights in the left outside mirror.

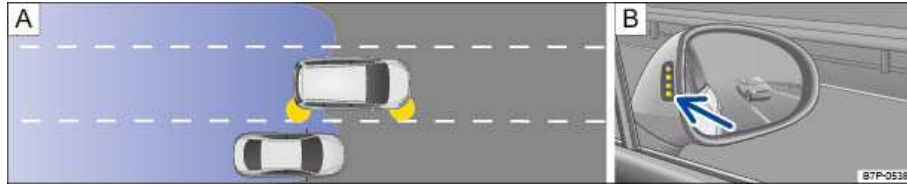

**Fig. 283** Driving with Side Assist: A: Passing another vehicle and moving to the right lane. B: Side Assist indicator lights in the right outside mirror.

ⓘ Please first read and note the introductory information and heed the WARNINGS ⚠

While driving Side Assist can detect and indicate other vehicles in the outside mirrors ⇒ [fig. 282 \(B\)](#) and ⇒ [fig. 283 \(B\)](#) in the following situations:

- When being passed by another vehicle or moving to another lane with rear traffic approaching your vehicle ⇒ [fig. 282 \(A\)](#).

- When passing another vehicle ⇒ [fig. 283 \(A\)](#), with a speed difference of up to 9 mph (15 km/h). When passing another vehicle faster than 9 mph (15 km/h), the indicator lights will not light up.

The faster another vehicle approaches, the sooner the indicator lights light up in the outside mirror, since the system also considers the speed difference of your vehicle to other vehicles. The indication of 2 vehicles in the same distance to your vehicle can occur at different times, if one of the vehicles is slower than the other.

### Special considerations when using Side Assist

In certain situations Side Assist may not be able to interpret the traffic surrounding your vehicle correctly. Amongst others, these situations may occur:

- In narrow curves.
- On roads with differently sized lanes, like in construction areas on highways.
- On hill tops.
- In bad weather conditions.
- When Side Assist detects fixed objects, such as guard rails or high mounted objects on the shoulder.

## Operating Side Assist

ⓘ Please first read and note the introductory information and heed the WARNINGS ⚠

### Activate and deactivate

Select **Assistants** from the main menu in the instrument cluster, then select  **Side Assist**.

If the check box in the instrument cluster menu is activated () , Side Assist is automatically enabled when the ignition is switched on.

As soon as Side Assist is ready, the indicator lights in the outside mirrors will light up briefly.

The indicator light in the instrument cluster shows the status of the system.

The stored settings are recalled when the ignition is switched on.

### Brightness

The brightness of the Indicator lights can be adjusted in the Volkswagen Information System ⇒ *Volkswagen Information System*. This should be done under normal daylight conditions, since the brightness of the indicator lights adjust to the ambient brightness.

Volkswagen recommends adjusting the brightness, so that the indicator lights are clearly visible under normal daylight conditions but don't reflect in the front windshield.

While adjusting the settings, Side Assist is not active.

### Automatic deactivation of Side Assist

The Side Assist radar sensors are automatically deactivated when they are permanently covered. This can be the case if they are covered with snow or ice ⇒ . In this event, a text message will appear in the display of the instrument cluster, to inform you about the deactivation.

In case of an automatic deactivation of Side Assist, the system can only activated by switching the ignition off and back on again.

### Trailer towing with Side Assist

Side Assist has to be deactivated manually when towing a trailer ⇒ *Trailer towing* !

### NOTICE

- In order for Side Assist to work correctly, the area of the radar sensors must be kept clean and clear of snow and ice.

## Rear Assist with dynamic orientation lines

### Introduction

---

In this section you'll find information about:

Operation

Camera

Rear Assist camera operation

Perpendicular parking (Mode 1)

Parallel parking (Mode 2)

A camera in the rear hatch ⇒ [fig. 284](#) assists the driver while backing up or maneuvering. The camera image is shown together with orientation lines and assistance areas projected by the system on the screen of the factory-installed radio or navigation system.

2 different orientation lines (modes) can be selected:

- **Mode 1:** Backing into a parking space at right angles to the direction of traffic, such as in a parking lot.
- **Mode 2:** Parallel parking in the direction of traffic, such as along the road side.

You can select the mode by tapping the function key on the factory-installed radio or navigation system screen. Only the mode selected is displayed.

The functions and displays of the Rear Assist camera may vary on vehicles with or without Optical Parking System (OPS).

#### **More information:**

- Exterior views
- Infotainment System
- Radio
- Park distance control system
- Parts, accessories, repairs and modifications

### **WARNING**

**Rear Assist is not able to give you a clear and undistorted view of all areas behind the vehicle.**

- **The Rear Assist camera has blind spots in which it cannot see people and objects.**
- **Always be careful and look around you when parking. The Rear Assist camera cannot show people, animals, and objects in certain situations. Watch out for small children and animals in particular.**
- **Due to the screen resolution, the camera may not pick up thin posts, chain-link fences and similar fences, and other objects, or it may show them unclear.**
- **The Rear Assist camera lens enlarges and distorts the field of vision and causes objects on the screen to appear altered and imprecise.**
- **Always keep the Rear Assist camera lens clean and free of snow and ice; do not cover the lens.**





## WARNING

Rear Assist technology cannot overcome the laws of physics and the limits of the system. Careless or unintentional use of Rear Assist may result in accidents and severe injuries.

- Always adjust your speed and driving style to road, traffic, weather, and visibility conditions.
- Always keep an eye on the parking direction and the vehicle surroundings. The front of the vehicle swings out more than the rear of the vehicle.
- Never pay so much attention to the graphics shown on the screen that you fail to notice what is going on around you.
- Always watch for people, especially small children, animals and objects, because the Rear Assist camera may not always be able to detect them.
- The system may not be able to clearly show everything behind the vehicle.
- Use Rear Assist only when the rear hatch is completely closed.



## NOTICE

- The Rear Assist camera shows only two-dimensional images on the screen. Due to the lack of depth of field, it may be difficult or impossible to identify protruding objects or recesses in the road, for example.
- Things like thin rods, fences, posts and trees may not be detected by the Rear Assist camera and could damage the vehicle.

## Operation

---

📖 Please first read and note the introductory information and heed the WARNINGS ⚠️

### Conditions for parking and maneuvering with reversing camera

#### Checklist

---



- ✓ The rear hatch must be closed.
  - ✓ A reliable and clear image is displayed and the Rear Assist camera lens is clean. ⇒ [fig. 284](#).
  - ✓ The area behind the vehicle can be seen clearly and completely.
  - ✓ The rear of the vehicle is **not** heavily loaded.
  - ✓ The driver is familiar with the system.
  - ✓ The position of the Rear Assist camera has **not** changed, such as after a rear-end collision. If the position of the camera has changed, have the system checked by an authorized Volkswagen dealer or an authorized Volkswagen Service Facility.
- 

Volkswagen recommends practicing parking and maneuvering with Rear Assist in a safe place with little or no traffic or in a parking lot under good visibility and weather conditions in order to familiarize yourself with the system, the orientation lines and the way they work.

#### Trailer towing

The Rear Assist system hides all orientation lines and assistance areas when the factory-installed trailer hitch has a trailer electrically connected.

### Rear Assist camera settings

Different setting such as *Brightness*, *Contrast* and *Color* can be adjusted by tapping the function keys  or  or moving the slider.

In order to change the settings follow these instructions:

- Park the vehicle in a safe place on a firm, level surface.
- Apply the electronic parking brake to help prevent the vehicle from moving ⇒ *Braking and parking*.
- Switch the ignition on.
- Turn on the infotainment system if not already on ⇒ *Introduction to the Infotainment System*.
- Place the transmission into Reverse (R) ⇒ *Shifting*.
- Tap the function key .
- Adjust the desired settings in the menu.

## Camera

---

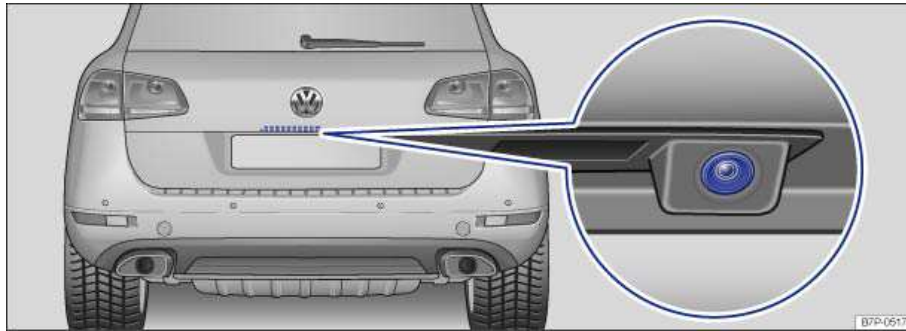

Fig. 284 In the rear hatch: Location of the Rear Assist camera.

 Please first read and note the introductory information and heed the WARNINGS 

The Rear Assist camera ⇒ fig. 284 (close-up) only shows two-dimensional images. Due to the lack of depth of field, it may be difficult or impossible to identify protruding objects or recesses in the road, for example.

Objects or another vehicle may seem closer or farther away on the screen than they really are:

### Examples of optical distortion by the Rear Assist camera:

---

- When driving from a level surface onto an upward or downward slope.
- When driving up or down a slope onto a level surface.
- If the rear of the vehicle is heavily loaded.

## Examples of optical distortion by the Rear Assist camera:

---

– When approaching protruding objects. These objects can disappear from the field of view when backing up.

### Cleaning the Rear Assist camera

Keep camera lens → [fig. 284](#) clean and free from snow and ice.

- Park the vehicle in a safe place on a firm, level surface.
- Apply the electronic parking brake to help prevent the vehicle from moving ⇒ *Braking and parking*.
- Wet the camera lens with a commercially available alcohol-based glass cleaner and clean with a dry cloth ⇒ ⚠.
- Remove snow with a brush.
- Remove ice with deicer spray ⇒ ⚠.

### ⚠ NOTICE

- **Never use abrasive cleaning agents to clean the camera lens.**
- **Never remove snow or ice on the camera lens with warm or hot water. This can damage the camera lens.**

**i** Volkswagen recommends practicing parking with Rear Assist in a safe place with little or no traffic or in a parking lot under good visibility and weather conditions in order to familiarize yourself with the system, the orientation lines and the way they work.

**i** Rear Assist cannot be activated when the factory-installed trailer hitch is electrically connected to the trailer or the rear hatch is open.

## Rear Assist camera operation

---

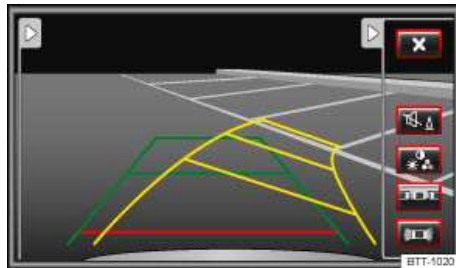

**Fig. 285** In the display perpendicular parking (Mode 1).

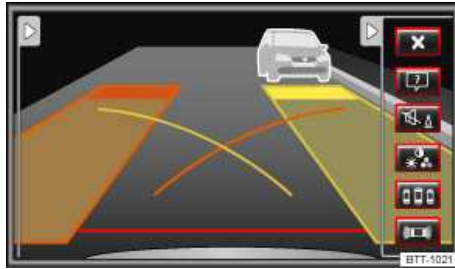

Fig. 286 In the display Parallel parking (Mode 2).



ⓘ Please first read and note the introductory information and heed the WARNINGS ⚠

Key to ⇒ fig. 285 and ⇒ fig. 286

Symbol	Meaning
◀	Left edge of the picture: Hide mini-OPS.
▶	Left edge of the picture: Display mini-OPS.
◀	Right edge of the picture: Hide menu.
▶	Right edge of the picture: Display menu.
✕	Leave the current display.
•	Switch the beeping signals from the Park Distance Control on or off (if equipped).
•	Display settings: Brightness, Contrast, Color.
🚗↔🚗	Currently in Mode 1: Press to switch to Mode 2.
•	Help menu for parking with mode 2
🚗↔🚗	Currently in Mode 2: Press to switch to Mode.
•	Display the Optical Parking System (if equipped).

#### Switching the Rear Assist camera on and off

The Rear Assist camera switches automatically on and off.

Function	With the ignition switched on	
	Vehicles without Park Distance Control	Vehicles with Optical Parking System
Switch on the display automatically:	Shift into Reverse <b>(R)</b> Mode 1 is displayed in the factory-installed radio or navigation system ⇒ <a href="#">fig. 285</a> .	
		Additionally, the mini-OPS will be displayed on the left edge of the factory-installed radio or navigation system screen.
Switch off the display automatically:	Turn off the ignition	
	<b>OR:</b> Drive forward faster than about 9 mph (15 km/h), or longer than about 10 seconds.	<b>OR:</b> Immediately after shifting out of Reverse <b>(R)</b> .
Hide the Rear Assist display:	Turn off the ignition <b>OR:</b> about 10 seconds after shifting out of Reverse <b>(R)</b> .	
	Press one of the factory-installed radio or navigation system buttons or tap the  function key.  The display will hide after about 10 seconds.	<b>OR:</b> Tap the function key  .  The OPS will be displayed full-screen.
Show the Rear Assist display again:	Shift into another gear position then back into Reverse <b>(R)</b> .	
		<b>OR:</b> Tap the function key  .

## Perpendicular parking (Mode 1)

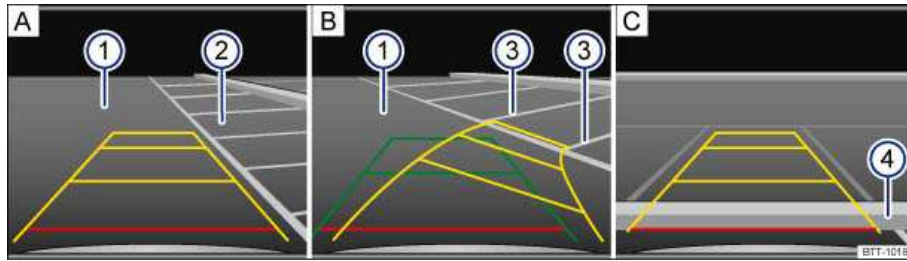

Fig. 287 Orientation lines for perpendicular parking (Mode 1).

ⓘ Please first read and note the introductory information and heed the WARNINGS ⚠

Key to ⇒ fig. 287:

	Meaning
<b>A</b>	Searching for a parking space ⇒ fig. 287 A.
<b>B</b>	Steering towards a selected parking space ⇒ fig. 287 B.
<b>C</b>	Maneuvering ⇒ fig. 287 C.
—	<p><b>Green lines:</b> Vehicle extension (somewhat wider) toward the rear. The green area ends about 6 feet (2 meters) behind the vehicle on the road.</p> <p>The angles of the lines do not change with the turning of the steering wheel, for orientation.</p>
—	<p><b>Yellow lines:</b> The extension of the vehicle to the rear shows the vehicle path as determined by the position of the steering wheel. The yellow area ends about 10 feet (3 meters) behind the vehicle on the road.</p>
—	<p><b>Horizontal red line:</b> Safety distance: Area up to about 16 inches (40 cm) behind the vehicle on the road.</p> <p>These lines do not change the orientation of the steering angle.</p>

**Key to ⇒ fig. 287:**

	<b>Meaning</b>
(1)	Road.
(2)	Selected parking space.
(3)	Orientation lines for the selected parking space.
(4)	Rear boundary of the parking space, such as a curb.

All lengths of the lines for orientation refer to a vehicle that is on a horizontal surface.

**Parking with the Rear Assist camera, perpendicular parking Mode 1**

The conditions for parking and maneuvering with reversing camera must be met

<b>Step</b>	<b>Perform the following actions:</b>
1.	Position the vehicle in front of a parking space (2) <b>A</b> .
2.	Shift into Reverse ( <b>R</b> ).
3.	Slowly back up and steer so that the yellow orientation lines (3) lead into the selected parking space <b>B</b> .  Observe the following message: <b>Look! Safe to move?</b> ⇒ ⚠ on page 492 !
4.	Align the vehicle in the parking space so that the green and yellow orientation lines (3) are parallel to the selected parking space <b>B</b> .
5.	At the latest when the rear boundary of the parking space, such as a curb (4) is reached, stop the vehicle <b>C</b> .

## Area View

### Introduction

---

In this section you'll find information about:

Area View

Operation instructions

Area View menus (modes)

There are 4 cameras in the radiator grille, the outside mirrors, and the rear hatch to assist the driver while parking, maneuvering, or driving off-road. The camera image is displayed on the system on the Infotainment System screen.

#### More Information:

- Exterior views
- Off-road driving
- Off-road driving situations
- Parts, accessories, repairs and modifications

#### WARNING

Using the cameras to estimate the distance to people and things around the vehicle can result in collisions and severe personal injury.

- The camera lenses enlarge and distort the field of vision and cause objects on the screen to appear altered and imprecise.
- Due to the screen resolution or in low-light conditions, the cameras may not pick up thin posts, chain-link fences and similar fences, and other objects, or it may not show them clearly.
- The cameras have blind spots in which they cannot detect people and objects.
- Always keep the camera lenses clean and free of snow and ice; do not cover the lenses.

#### WARNING

Area View technology cannot overcome the laws of physics and the limits of the system. Careless or unintentional use of Area View may result in accidents and severe injuries.

- Always adjust your speed and driving style to road, traffic, weather, and visibility conditions.
- Never pay so much attention to the graphics shown on the screen that you fail to notice what is going on around you.
- Always watch for people, especially small children, animals, and objects, because the cameras may not always be able to detect them.
- The system may not be able to clearly show everything behind the vehicle.



## ! NOTICE

- The camera shows only two-dimensional images on the screen. Due to the lack of depth of field, it may be difficult or impossible to identify protruding objects or recesses in the road, for example.
- Things like thin rods, fences, posts, and trees may not be detected by the camera and could damage the vehicle.

## Area View

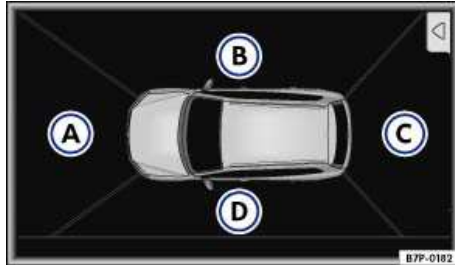



Fig. 293 Display of the Area View: Bird's eye view.

ⓘ Please first read and note the introductory information and heed the WARNINGS ⚠













There are 4 different camera views ⇒ fig. 293:

- (A) Front camera area.
- (B) Right camera area.
- (C) Rear camera area.
- (D) Left camera area.

A bird's eye view  is created by showing all camera views. The bird's eye view can be selected by tapping the *vehicle* within the area ⇒ fig. 294 (A).

Select the different camera views by tapping the individual areas in the bird's eye view ⇒ fig. 293 (A) to (D) or mini bird's eye view ⇒ fig. 294 (A).

### Camera views

- **Bird's eye view:** For an all-round view of the vehicle , also for off-road driving . The bird's eye view is shown on the full screen ⇒ fig. 293.
- **Front View:** To see cross-traffic in front of the vehicle , for forward perpendicular parking , when approaching an obstacle, and for off-road driving .
- **Side View:** To see the area to the immediate left  or right  of the vehicle, for parking, or for off-road driving .
- **Rear View:** To see cross-traffic behind the vehicle , for reverse perpendicular parking , for reverse parallel parking  and when hitching up a trailer to the vehicle .

The selected individual camera view is displayed on the right-hand side of the screen ⇒ fig. 294 (B). It is marked by a colored frame in the mini bird's eye view ⇒ fig. 294 (A) shown on the left. In addition, the available menu options and possible camera views (referred to as "modes") for the corresponding camera are shown on the right-hand side of the screen ⇒ fig. 294 (D). The view (mode) that is currently active is marked.

## Operation instructions

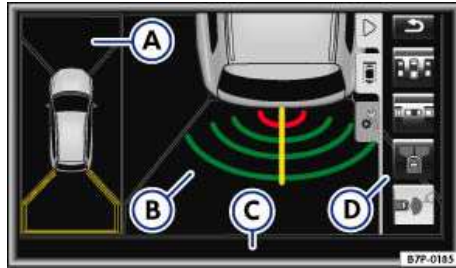

Fig. 294 Display of the Area View: Trailer hitch activated.



Fig. 295 In the upper center console: Button to activate Area View manually.

**⚠ Please first read and note the introductory information and heed the WARNINGS ⚠**

Function areas on the screen ⇒ [fig. 294](#):

- (A) Mini bird's eye view. The selected camera is marked by a colored frame.
- (B) Display of selected camera's view.
- (C) Text messages.
- (D) Menu options:
  - Hide the menu,
  - Display the menu,
  - Leave the current display.Function keys to select the current view.  
Function key for settings on the Infotainment System screen.

### Activating and deactivating Area View

Manually activate display:	Press button ⇒ <a href="#">fig. 295</a> . The bird's eye view is activated on the Infotainment System screen ⇒ <a href="#">fig. 293</a> . The display will not switch on at speeds above about 9 mph (15 km/h).
----------------------------	---

## Activating and deactivating Area View

Automatically activate display:	Shift into Reverse ( <b>R</b> ). The camera view behind the vehicle is displayed in perpendicular parking mode with the mini bird's eye view ⇒ <a href="#">fig. 294 (A)</a> .
Manually deactivate display:	Press button ⇒ <a href="#">fig. 295</a> again.
Automatically deactivate display:	Drive forward faster than about 9 mph (15 km/h). <b>OR:</b> Switch off the ignition. The Area View display screen turns off after a few seconds.

### Special considerations

#### 1) Do not use Area View in the following situations:

- When an incorrect or unclear image is displayed, such as when there is poor visibility or the lens is dirty.
- If the area behind the vehicle cannot be seen clearly or completely.
- If the rear of the vehicle is heavily loaded.
- If the driver is not familiar with the system.
- If the position or angle of the cameras has changed, such as after an accident. Have the system checked by an authorized Volkswagen dealer or an authorized Volkswagen Service Facility.

#### 2) Examples of optical distortion by the camera:

The Area View cameras display only two-dimensional images. Recesses and protruding objects on the ground or protruding parts on other vehicles are difficult or impossible to identify due to the lack of depth of field.

## 2) Examples of optical distortion by the camera:

---

---

Objects or another vehicle may seem closer or farther away on the screen than they really are:

---

- When driving from a level surface onto an upward or downward slope.

---

- When driving up or down a slope onto a level surface.

---

- If the rear of the vehicle is heavily loaded.

---

- When approaching protruding objects. These objects can disappear from the field of view when approaching them.



### NOTICE

- **Never use abrasive cleaning agents to clean the camera lenses.**
- **Never remove snow or ice on the camera lenses with warm or hot water. This can damage the camera lenses.**



Volkswagen recommends practicing using the Area View system in a safe place with little or no traffic or in a parking lot in order to familiarize yourself with the system and the way it works.

## Area View menus (modes)

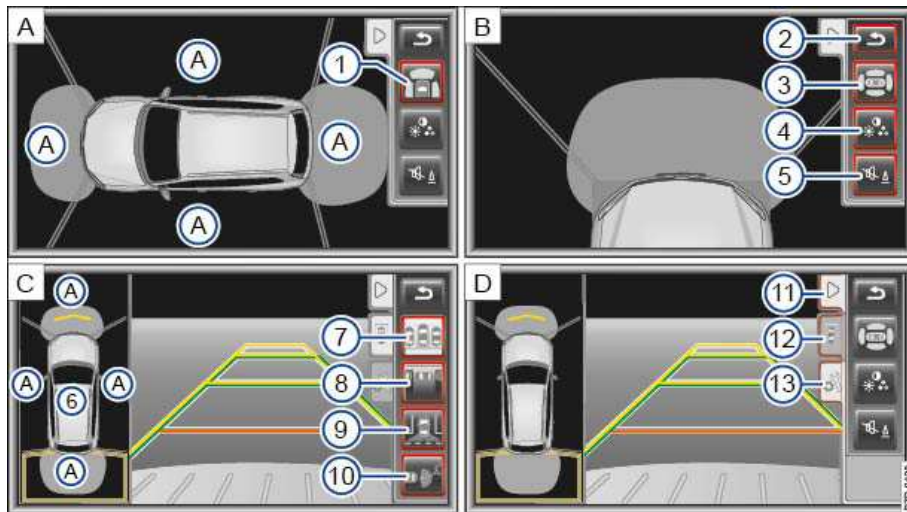

**Fig. 296** Display of the Area View: Full-screen bird's eye view (option A), enlarged off-road view (option B), partial view of perpendicular parking with modes menu (option C) and partial view of perpendicular parking with settings menu (option D).

**⚠ Please first read and note the introductory information and heed the WARNINGS ⚠**

Function areas on the screen ⇒ [fig. 296](#):



- (A) Activate front, side or rear camera view.
- (1) Activate enlarged off-road view.
- (2) Leave the current display.
- (3) Activate bird's eye view.
- (4) Adjust display: brightness, contrast, color.
- (5) Turn off sound for Park Distance Control.
- (6) Activate full-screen bird's eye view.
- (7) Activate rear perpendicular parking view.
- (8) Activate rear parallel parking view
- (9) Activate rear cross-traffic view.
- (10) Activate trailer support view.
- (11) Hide menu.
- (12) Activate mode menu.
- (13) Activate settings menu.

### Bird's eye views



View	Screen display of all cameras
Main mode 	The vehicle and its immediate surroundings are shown in the bird's eye view ⇒ <a href="#">fig. 296 A</a> .

View	Screen display of all cameras
Off-road 	The areas directly in front of the vehicle and partly to the side of the vehicle are displayed as a bird's eye view. This can be used, for example, when driving across a slope so that the area around the vehicle can be seen => <a href="#">fig. 296 B</a> .





#### Front camera views

View	Screen display of front camera
Front cross-traffic 	Area on left of screen: Left-hand side of intersection. Area in center of screen: Area directly in front of vehicle. Area on right of screen: Right-hand side of intersection.
Perpendicular parking 	The area in front of the vehicle is displayed. Orientation lines are displayed for assistance. See Rear Assist Mode 1
Off-road 	The area directly in front of the vehicle is shown in a bird's eye view. This can be used, for example, when driving across a slope so that the area directly in front of the vehicle can be seen more easily.

#### Side camera views





View	Screen display of side cameras
Off-road, left and right side 	Areas directly next to the vehicle are displayed in a bird's eye view so you can steer the vehicle accurately around obstacles. The red lines are displayed when an obstacle is about 16 inches (40 cm) from the vehicle.
Left side 	Shows the driver or front passenger side => <a href="#">fig. 296 D</a> next to the vehicle separately as a bird's eye view. This helps you to see the blind spot along the side of the vehicle.
Right side 	



## Rear camera views

View	Screen display of rear camera
Perpendicular parking 	The area behind the vehicle is displayed. Orientation lines are displayed for assistance. See Rear Assist Mode 1
Parallel parking 	The area directly behind the vehicle is displayed. The colored areas and lines are provided for orientation. See Rear Assist Mode 2
Trailer hitch 	The rear of the vehicle is displayed. The red line and the green lines are used to indicate the distance. The distance between the green lines and the red line is about 12 inches (30 cm) each. The distance between the red line and the vehicle is also about 12 inches (30 cm). The yellow line indicates the extension of the trailer hitch towards the rear and shows the direction to the trailer hitch depending on the position of the steering wheel.
Rear cross-traffic 	Area on left of screen: Left-hand side of intersection. Area in center of screen: Area directly behind the vehicle. Area on right of screen: Right-hand side of intersection.

## Settings on the Infotainment System screen

Tap the function key (5), to adjust the following settings:

Function key	Action
Brightness	Tap the function key  or  .
	<b>OR:</b> Move the slider to set different brightness levels.
Contrast	Tap the function key  or  .
	<b>OR:</b> Move the slider to set different contrast levels.

Function key	Action
Color	Tap the function key  or  . <b>OR:</b> Move the slider to set different color levels.



# Park Distance Control (PDC)

## Introduction

---

In this section you'll find information about:

Park Distance Control  
Optical Parking System (OPS)

If your vehicle is equipped with this feature, it will have Park Distance Control sensors in the front and rear bumpers.

The Park Distance Control system (PDC) and the Optical Parking System (OPS) can help the driver when backing up and parking. PDC uses ultrasonic sensors in the bumpers to measure the distance between the vehicle and objects in front and in back of the vehicle. The system uses the time it takes for the ultrasonic waves to bounce back from the object to calculate the distance between the vehicle and an object. Park Distance Control works only at speeds up to about 6-9 mph (10-15 km/h).

If the vehicle gets too close to an obstacle in front or behind it, a beeping signal sounds. The closer the vehicle gets to the obstacle, the faster the beep. When the obstacle is very close, the sound is continuous.

If you move even closer to the obstacle despite the continuous warning sound, the system cannot measure the distance remaining until collision.

A Declaration of Compliance with the United States FCC and Industry Canada regulations is found on ⇒ *Declaration of Compliance, Telecommunications and Electronic Systems.*

### More information:

- Exterior views
- Infotainment System
- Braking and parking
- Exterior care and cleaning
- Parts, accessories, repairs and modifications
- Consumer information

### WARNING

**Park Distance Control and the Optical Parking System are not a substitute for careful and attentive driving. Never rely completely on these systems for information about people and objects that might be in the way of the vehicle and could be struck resulting in serious personal injuries.**

- **The sensors have blind spots in which they cannot detect people, animals, and objects.**
- **Always be careful and look around you when parking. The sensors cannot always detect people, animals, and objects. Watch out for small children and animals in particular.**
- **Certain types of clothing and the surfaces of certain objects do not reflect the ultrasonic waves that the sensors send and receive. Such objects and persons wearing such clothing will not be detected by PDC or will not be detected accurately.**
- **Noise in the area can interfere with the signals of the Park Distance Control sensors. Under certain circumstances, the system will not detect people and objects for this reason.**

## NOTICE

- Things like trailer draw bars, thin rods, fences, trees, and narrow painted vertical poles or posts may not be detected by the Park Distance Control and Optical Parking System sensors and could damage the vehicle.
- If you continue driving closer to an object that the Park Distance Control and Optical Parking Systems have already detected and reported, the object may disappear from the sensor range and may no longer be detected. This is especially true for low or high objects. The system will no longer sound warnings about these objects. Ignoring signals from the Park Distance Control system could result in serious damage to the vehicle.
- The sensors in the bumper can be damaged or become misaligned in low speed impacts and parking maneuvers. Damaged or misaligned sensors cannot accurately detect or report objects that might be within range of the PDC system
- To help make sure that the system works properly, always keep the sensors in the bumpers clean, free of snow and ice; do not cover the sensors with stickers or other objects.
- When cleaning the sensors with power washers or steam cleaners, only spray the sensors directly for a very short time, and always keep the washer nozzle at least 4 inches (10 cm) from the sensors.
- Noise from rough roads, cobblestones, other vehicles and the surrounding area, for example, can prevent the Park Distance Control system from accurately detecting and reporting people and objects that may be within range of the system sensors.
- Aftermarket components such as bicycle racks can impair the function of the Park Distance Control system.

 Volkswagen recommends practicing with the Park Distance Control and the Optical Parking System in a location or parking space with no traffic in order to become familiar with the system and how it works.

## Park Distance Control

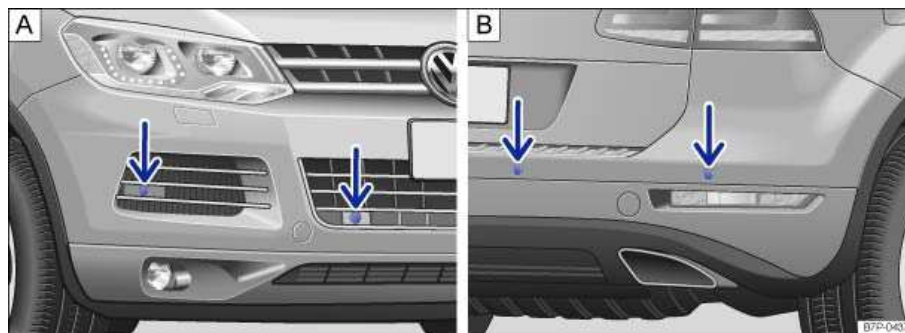
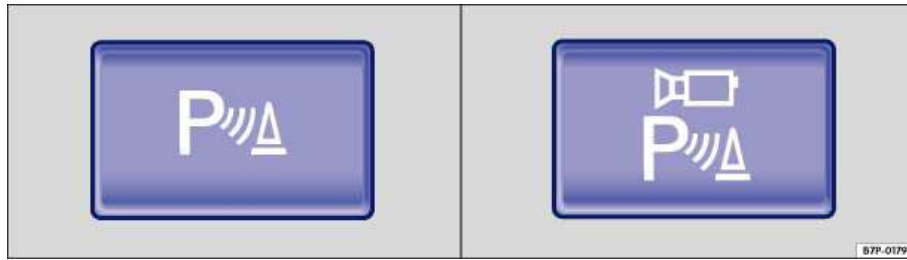

Fig. 297 On the front and rear bumper: Park Distance Control system sensors.





**Fig. 298** In the upper front center console: Different versions of the button for switching Park Distance Control on and off.

**ⓘ Please first read and note the introductory information and heed the WARNINGS ⚠**

There are 4 sensors in each bumper ⇒ [fig. 297](#) (arrows).

In order to	Operation
Manually activate the PDC:	Press the  or  button <i>once</i> when the ignition is switched on.
Manually deactivate the PDC:	Push the  or  button <i>again</i> when the ignition is switched on.
Manually deactivate the OPS small-screen display:	Press a function selection button on the Infotainment System or <b>SETUP</b> .
	<b>OR:</b> Tap the function key  or <b>Return</b> .
	<b>OR:</b> Tap the  function key ⇒ <a href="#">fig. 299</a> .
Automatically activate the PDC:	Shift into Reverse <b>R</b> when the ignition is on or engine is running.
	<b>OR:</b> Drive forward slowly (less than about 5 – 10 mph /10 – 15 km/h) and approach to within about 38 inches (95 cm) of an obstacle.

In order to	Operation
	<b>OR:</b> If the vehicle rolls backwards.
Automatically deactivate the PDC:	Drive forward faster than about 5 – 10 mph (10 – 15 km/h). <b>OR:</b> Shift into Reverse <b>R</b> .
Switch to full-screen view:	Vehicle rolls backwards slowly. <b>OR:</b> Press the lit-up button  or  <b>OR:</b> Tap the <b>OPS</b> function key ⇒ <a href="#">fig. 299</a> .

The indicator light in the button  ⇒ [fig. 298](#) comes on and stays on as long as the feature is active.

A chime sounds to tell you that the system is on. If the chime does **not** sound, PDC is not working. Have the system inspected by an authorized Volkswagen dealer or an authorized Volkswagen Service Facility.

#### Special considerations when using Park Distance Control

- In some cases, the Park Distance Control system interprets water and ice on the sensors as an obstacle. To prevent automatic PDC activation in these cases, you can turn Park Distance Control off permanently in the Infotainment System ⇒ *Automatic activation in the Infotainment System*.
- If the distance remains the same, the warning tone volume decreases after a few seconds. If a continuous tone sounds, its volume remains the same.
- If the vehicle moves away from the obstacle, the beeping sound stops automatically. The beep turns on once more automatically if the vehicle approaches the obstacle again.
- There is no beeping when the transmission is in Park (**P**) or the electronic parking brake is engaged.
- The volume of the audible signals can be adjusted by an authorized Volkswagen dealership or an authorized Volkswagen Service Facility.



#### WARNING

**Never rely completely on the PDC for information about people and objects that might be in the way of the vehicle and could be struck by the vehicle causing serious personal injury.**

- **The PDC sensors have blind spots where they cannot detect people or objects.**
- **Always watch for people, especially small children and animals, because the sensors may not always be able to detect them.**



If you hear a long beep lasting about 3 seconds when you first turn PDC on or the indicator light in the button starts blinking, this means there is a malfunction in the Park Distance Control system. Switch off the Park Distance Control system with the button and have it immediately checked by an authorized Volkswagen dealer or an authorized Volkswagen Service Facility.

## Optical Parking System (OPS)

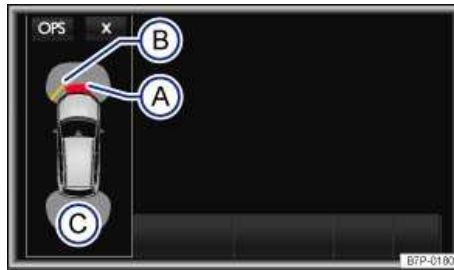

Fig. 299 OPS screen display: Small-screen display.

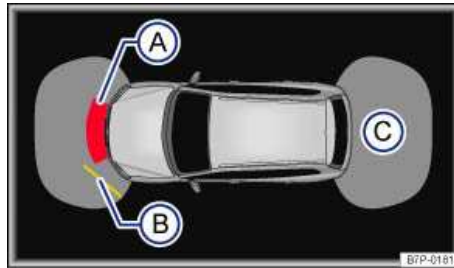

Fig. 300 OPS screen display: Full-screen display.

⚠ Please first read and note the introductory information and heed the WARNINGS ⚠

Key to fig. 299 and fig. 300:

- (A) Obstacle detected in collision zone.
- (B) Obstacle detected in scanned area.
- (C) Scanned area behind the vehicle.

The Optical Parking System is an enhancement of the Park Distance Control system ⇒ *Park Distance Control*.

The areas scanned by the sensors *in front of* and *behind* the vehicle are displayed on the screen of the factory-installed Infotainment System. Potential obstacles are shown relative to the vehicle ⇒ ⚠.









If you approach to within about 38 inches (95 cm) of an obstacle at a speed of less than about 5 - 10 mph / 10 - 15 km/h, the small-screen OPS view is displayed. An indicator light comes on (PWA) or (SW).

### Automatic activation in the Infotainment System

Automatic activation of the small-screen OPS display can be switched on and off in the Infotainment System.

- Switch on the ignition.
- Press the **CAR** Infotainment button.
- Tap the **Assist systems** function key on the screen.
- Select **Parking Distance Warning System** from the list.

If the OPS small-screen display has been disabled, Park Distance Control can only be switched on by pressing the button (PWA) or (SW) or by putting the vehicle in Reverse (R).

Function	Proper response
Automatically activate the OPS small-screen display:	By approaching to within about 38 inches (95 cm) of an obstacle at a speed of less than about 5 - 10 mph (10 - 15 km/h).
Manually deactivate the OPS small-screen display:	Tap the  function key ⇒ <a href="#">fig. 299</a> .
Switch to full-screen view:	Vehicle rolls backwards slowly. <b>OR:</b> Press the lit-up button  or  <b>OR:</b> Tap the  function key ⇒ <a href="#">fig. 299</a> .
Automatically switch on the display:	By putting the vehicle in Reverse. <b>OR:</b> Vehicle rolls backwards.
Manually switch on the display:	Press the  or  button.
Manually deactivate the display:	Press the  or  button <i>again</i> .
Automatically deactivate the display:	Drive forward faster than about 5 - 10 mph (10 - 15 km/h).

### Scanned areas

*In front* of the vehicle, the area in which obstacles are detected extends about 48 inches (120 cm) straight ahead and up to 24 inches (60 cm) to either side. *Behind* the vehicle, the area scanned area extends about 5 ft. 4 inches (160 cm) to the rear and about 2 ft. (60 cm) to either side (C) and ⇒ [fig. 300 \(C\)](#).

When the system is activated automatically, the acoustic signal sounds only if an object is detected in the area about 20 inches (50 cm) to the *front* or *rear* of the vehicle.

### Screen display

The display shows the scanned area in several segments. The closer the vehicle gets to the obstacle, the closer the segment advances to the displayed vehicle ⇒ [fig. 299 \(B\)](#) and ⇒ [fig. 300 \(B\)](#).

When the next-to-last segment is displayed, you have reached the collision zone. **Stop the vehicle!**

Distance between vehicle and obstacle	Audible signal	Screen: Segment color if obstacle detected
Front: about <b>12 – 48 inches (31 – 120 cm)</b> Rear: about <b>12 – 64 inches (31 – 160 cm)</b>	Beep tone if manually activated.	Yellow
Front: about <b>12 – 20 inches (31 – 50 cm)</b> Rear: about <b>12 – 20 inches (31 – 50 cm)</b>	Beep tone if automatically activated.	Yellow
About <b>0 – 12 inches (0 – 30 cm)</b> front or rear	Continuous tone.	Red

The distance at which the continuous tone sounds is somewhat greater for vehicles with a factory-installed trailer hitch.

#### Infotainment System settings for OPS

A number of settings can be selected in the Infotainment System.

- Switch on the ignition.
- Press the **CAR** Infotainment button.
- Tap the **Assist systems** function key on the screen.
- Select **Parking Distance Warning System** from the list.

#### Function key: Actions

**Front volume/tone level**: Different volume and pitches can be separately selected for front by tapping the **-** or **+** function keys or by moving the slider.

**Rear volume/tone level**: Different volume and pitches can be separately selected for rear by tapping the **-** or **+** function keys or by moving the slider.

**Reduced audio volume**: Different volume and pitches can be separately selected for front and rear by tapping the **-** or **+** function keys or by moving the slider.

## Function key: Actions

---

**Automatic activation of mini-OPS:** If the check box in the function key is checked , the small screen OPS display is automatically switched on when you slowly approach an obstacle. To switch off this feature, tap **Automatic activation of mini-OPS**. After deactivation, there will not be any warning when you approach an obstacle.

---

**Reset settings:** Resets all settings to the factory settings.

---

### When towing a trailer

On vehicles with a factory-installed trailer hitch and an electrically connected trailer, a corresponding graphic is displayed on the screen. Distance values behind the vehicles will not be displayed.

### Muting the Park Distance Control volume

You can mute the PDC beeping signals by tapping the  function key on the Radio or Navigation system screen. Tap the function key again to reactivate the acoustic signals.

Muting is cancelled by switching Park Distance Control back on after it was switched off. The warning messages cannot be switched off.

If the display has been switched off manually and PDC remains active, the mute setting is also cancelled.

Switching Park Distance Control back on after it was switched off reactivates the volume. System malfunction warning signals cannot be switched off.

### WARNING

**Never rely completely on the OPS for information about people and objects that might be in the way of the vehicle and could be struck by the vehicle causing serious personal injury.**

- The OPS sensors have blind spots where they cannot detect persons or objects.
- Never pay so much attention to the OPS and the graphics shown on the screen that you fail to notice what is going on around you.
- Always watch for people, especially small children and animals, because the sensors may not always be able to detect them.

### NOTICE

**Automatic activation of OPS when approaching an obstacle works only when your speed falls below a threshold of about 5 - 10 mph (10 - 15 km/h). If you then close the display, you must either switch the ignition off and back on or exceed the speed threshold and then reduce speed to under the threshold a second time in order for it to activate automatically again.**

 Volkswagen recommends practice parking with Park Distance Control and the Optical Parking System on a parking lot or other place where there is little traffic to get used to how the system works.



# Heating and air conditioning

## Introduction

---

In this section you'll find information about:

Climatronic controls  
Operation via the Infotainment System  
Operation  
Air vents  
Air recirculation  
Heated steering wheel

### **Climatronic air conditioning (A/C)**

**Your vehicle is equipped with a Climatronic climate control system.** On vehicles with Climatronic climate control, system status messages will appear briefly in the Climatronic display and/or on the factory-installed Radio system or Radio & Navigation system.

You can use the Infotainment System to change the units in which temperatures are displayed.

The temperature units (Fahrenheit or Celsius) in the factory installed radio or navigation system screen can be changed in the **Settings** menu in the Premium instrument cluster display in appropriately equipped vehicles.

### **The dust and pollen filter**

The dust and pollen filter with an activated carbon insert reduces the entry of pollutants into the passenger compartment.

The dust and pollen filter must be replaced at the intervals recommended in ⇒ Booklet *Warranty and Maintenance* so that the air conditioner can work properly.

If the effectiveness of the filter decreases prematurely due to operating the vehicle where the outside air is heavily polluted, the dust and pollen filter should be replaced more frequently than indicated.

### **More information:**

- Exterior views
- Passenger compartment
- Volkswagen Information System
- Seat functions
- Windshield wiper and washer
- Infotainment System
- Starting and stopping the engine
- Exterior care and cleaning



### WARNING

Poor visibility increases the risk of collisions and other accidents that cause serious personal injuries.

- Always make sure all windows are clear of ice, snow and condensation for good visibility to the front, sides, and rear.
- Maximum heating output and fast defrosting will only be possible after the engine has reached operating temperature. Wait until you have good visibility before driving off.
- Always make sure you know how to properly use the heating and ventilation systems as well as the rear window defroster that you will need for good visibility.
- Never use air recirculation for long periods of time. When the air conditioner is off and recirculation mode is on, condensation can quickly form on the windows and greatly reduce visibility.
- Always switch off recirculation mode when it is not needed.



### WARNING

Stale air causes driver fatigue and reduces driver alertness, which can cause accidents, collisions and serious personal injury.

- Never switch off the fan for a long period of time and never use air recirculation a long period of time because no fresh air will come into the passenger compartment.



### NOTICE

- If you think the air conditioner is not working properly or may be damaged, switch it off to help prevent more damage. Have the air conditioner checked by an authorized Volkswagen dealer or authorized Volkswagen Service Facility.
- Air conditioner repair requires specialized knowledge and special tools. Volkswagen recommends that you see an authorized Volkswagen dealer or an authorized Volkswagen Service Facility.
- Do not smoke when air recirculation is switched on. Smoke drawn into the ventilation system can leave residue on the evaporator and on the dust and pollen active carbon filter, resulting in permanent odors whenever the air conditioner is switched on.



If the air conditioner is switched off, the fresh outside air will not be dehumidified. To help keep the windows from fogging over, Volkswagen recommends leaving the air conditioner (compressor) switched on. Press the **A/C** button. The indicator light in the button must come on.



When it is very hot and humid outside, **water condensation** can drip from the air conditioner evaporator and form a puddle under the vehicle. This is normal and does not indicate a leak.



Keep the air intake slots in front of the windshield free of ice, snow and leaves in order to maintain proper functioning of the heating and ventilation systems.



Maximum heating output and defrosting performance are not possible until the engine has reached operating temperature.

 Emergency starting and starting the engine with a very weak vehicle battery or after the vehicle battery has been replaced may change or delete system settings (including time, date, personal convenience settings and programming). Check the settings and correct as necessary once the vehicle battery has built up a sufficient charge.

## Climatronic controls

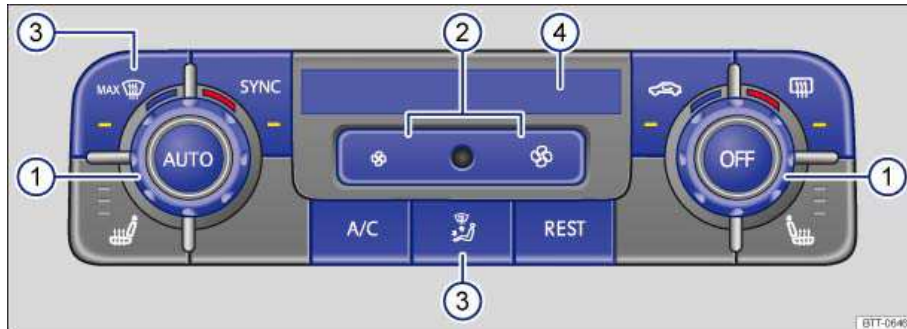









Fig. 301 In the front center console: Climatronic controls.

 Please first read and note the introductory information and heed the WARNINGS

Press the corresponding button to switch a feature on or off. The respective button needs to be pushed several times for adjustable functions. The indicator lights in the buttons and the information shown in the Climatronic control display  $\Rightarrow$  fig. 301 (4) and on the Infotainment System screen provide feedback on the activation of the selected functions.

The LEDs in a particular button lights up to show that the feature is activated.

Button/Knob	More information. Front Climatronic controls $\Rightarrow$ fig. 301.
(1) 	Temperature: Left and right sides separately and continuously adjustable. Turn the knob to set the temperature. Temperature is shown in the Climatronic display.
(2) 	Fan: Manual fan speed adjustment. Setting 0: fan and Climatronic switched off.
(3) 	Air distribution: Can be selected manually via button.

Button/Knob	More information. Front Climatronic controls ⇒ <a href="#">fig. 301</a> .
	Defog / defrost button: The incoming outside air is directed to the windshield, and air recirculation is automatically disabled. At temperatures above +38 °F (+3 °C), the air is dehumidified and the fan is set to high speed so as to defog/defrost the windshield as quickly as possible.
<b>SYNC</b>	Apply the driver settings to all climate zones ⇒ page 526.
	Air recirculation
	Rear window defroster: works only when the engine is running or, on hybrid vehicles, when the vehicle is ready to drive; switches itself off after 10 minutes at the latest.
<b>A/C</b>	Switch cooling system on and off.
	Air distribution to the windshield, the upper body, and the footwells. Push the button repeatedly until you get the setting you want; the selected setting is shown in the front Climatronic display.
<b>REST</b>	Residual heat mode
<b>AUTO</b>	Automatic temperature, fan, and air distribution control.
<b>OFF</b>	Switch off: Press <b>OFF</b> button or adjust manually to 0. This switches Climatronic off entirely. <b>OFF</b> lights up in the front Climatronic display.



#### WARNING

Stale air causes driver fatigue and reduces alertness, which can cause accidents, collisions and serious personal injury.

- Never switch off the fan for a long time and never use air recirculation a long period of time because no fresh air will enter the passenger compartment.

## Operation via the Infotainment System



Fig. 302 Infotainment System: Front climate control settings.

**ⓘ Please first read and note the introductory information and heed the WARNINGS ⚠**

You can use the Infotainment System to control Climatronic. To access the main menu, push the **CLIMATE** Infotainment button.

Tap the appropriate function key to switch a feature on or off. Feedback on the activation of the selected feature will appear in the Infotainment System screen.

A feature is turned on if its function key check box  is checked.

Function key	More information. Front Climatronic controls ⇒ <a href="#">fig. 302</a> .
	Air distribution to the windshield.
	Air distribution to the upper body.
	Air distribution in the footwells.
	Air distribution to the upper body and the footwells.
	Air distribution to the windshield and footwells.
	Heated steering wheel: The steering wheel is heated to about +77 °F (+25 °C) and held constant at about this temperature.
<b>AUTO</b>	Automatic temperature, fan, and air distribution control. By tapping the function key repeatedly, you can select from the air conditioning profiles Low, Medium, and High in AUTO mode.
Fan switch	Manual fan speed adjustment. Setting 0: fan and Climatronic switched off.

<b>Function key</b>	<b>More information. Front Climatronic controls ⇒ fig. 302.</b>
* 	
<b>Extras</b>	<p>Depending on equipment version, the following adjustments are possible after tapping the function key <b>Extras</b>:</p> <p><b>Air conditioning profile</b> feature key for setting fan speed in AUTO mode. You can choose between Low, Medium, and High.</p> <p><b>Automatic air recirculation</b> feature key</p>

## Operation

### Please first read and note the introductory information and heed the WARNINGS

The air conditioner works only when the ignition is switched on. The cooling system for the passenger compartment works only when the engine is running (or when a hybrid vehicle is ready to drive) and the fan is on.

When the ignition is switched off, you will only be able to switch on the residual heat feature.

The air conditioning system is most efficient when the windows and the power sunroof are closed. If the vehicle is not moving and the passenger compartment becomes very hot due to sunlight, briefly opening the windows may speed up the cooling process.

Keep the air intake slots in front of the windshield free of ice, snow and leaves so that the heating and ventilation systems can work properly.

The front seating positions are referred to as “climate zones”. Different climate control settings may be used for each climate zone.

### Settings for optimum visibility

When you switch on the cooling system, both the temperature and humidity in the vehicle are reduced. This will help make passengers feel more comfortable and prevent windows from fogging up.

- Press the **AUTO** button.
- Set temperature to +72 °F (+22 °C).
- Open air vents in the instrument panel ⇒ *Air vents*.

### Heating

Maximum heating output and fast defrosting will only be possible after the engine has reached operating temperature.

### Switching between Fahrenheit and Celsius in Climatronic

You can switch between Celsius and Fahrenheit for the temperature display using the Setup menu in the Infotainment System.

- Press the **SETUP** Infotainment button.
- Press the **System** feature key.

- Press the **Units** feature key.
- Select the desired unit.

### Automatic window fog detection

Automatic window fog detection checks whether the windows are fogged up and if necessary automatically adjusts the air flow to the windshield and side windows or switches on the windshield heating. If the fan or the air conditioner **A/C** is turned off, automatic window fog detection cannot work properly.

### Residual heat mode

The residual engine heat can be used for a limited time to heat the passenger compartment when the ignition is switched off.

- Switch off the ignition.
- Push the **REST** button. The feature will appear in the Climatronic display.
- Press the **REST** button again to switch the feature off early.

The feature is switched off if it is draining the battery too much, and it does not turn off automatically after 30 minutes. The fan speed is reduced to save energy.

### Applying driver settings to all climate zones

The driver-side settings for temperature, fan speed, and air distribution can be applied to all of the other climate zones.

- Push the **SYNC** button. The indicator light in the button lights up and the changes are applied to all climate zones.
- Push the **SYNC** button again to cancel the feature.

The synchronization feature is deactivated if individual settings are entered for one of the other climate zones using the Climatronic control unit. In this case, the indicator light in the **SYNC** button goes out.

### Air conditioner does not work

The air conditioner may not switch on for one of the following reasons:

- The engine is not running (or a hybrid vehicle is not ready to drive).
- The fan is turned off.
- The air conditioner fuse has blown.
- The ambient air temperature is colder than +38 °F (+3 °C).
- The air conditioner compressor has been temporarily switched off due to excessive engine coolant temperature.
- There is another malfunction in the vehicle. Have the air conditioner checked by an authorized Volkswagen dealer or authorized Volkswagen Service Facility.

### Special considerations

When it is very hot and humid outside, **water condensation** can drip from the air conditioner evaporator and form a puddle under the vehicle. This is normal and does not indicate a leak.

 The climate control system adjusts the passenger compartment temperature as fast as possible considering the outside temperature.

 Due to residual moisture in the air conditioner, the windshield may fog up after the engine is started. Switch on the windshield defroster to help evaporate the condensation as quickly as possible.

 The air coming out the vents and flow through the passenger compartment and out through the vents below the rear window. Do not cover these slots with clothing or other objects.

## Air vents



Fig. 303 Air vents in the instrument panel.

☑ Please first read and note the introductory information and heed the WARNINGS ⚠

### Air vents

To help ensure sufficient heating, cooling and ventilation in the passenger compartment, never close the air vents ⇒ fig. 303 (1) completely.

- To open and close the air vents, turn the thumbwheel below the vents in the desired direction.
- Use the lever on the vent grille to adjust the airflow direction.

Additional, non-adjustable air vents (2) are located in the door pillars and the instrument panel, in the footwells, as well as in the rear area of the passenger compartment.

### Indirect ventilation

Indirect ventilation is provided via generously proportioned vents in the top of the instrument panel (3).

When the air conditioner is in automatic mode, indirect ventilation is controlled automatically. If necessary, it is switched to direct ventilation in order to reach the desired interior temperature.

### ⚠ NOTICE

Do not place food, medications, or other heat-sensitive things in front of the air vents. Food, medications, and other things that are sensitive to heat or cold can be damaged or made unusable by the air flow from the vents.

## Air recirculation

☑ Please first read and note the introductory information and heed the WARNINGS ⚠

### General information

There are different types of air recirculation:

	Manual air recirculation.
	Automatic air recirculation.





The air recirculation mode helps prevent outside air from entering the vehicle interior.

In very hot or cold outside temperatures, temporarily switch to manual air recirculation in order to cool or heat the vehicle interior faster.

For safety reasons, air recirculation is switched off if you push the **MAX** button ⇒ .

#### Switching air recirculation on and off manually

*Switching on:* Press the  button repeatedly until the indicator light in the button comes on.

*Switching off:* Press the  button repeatedly until the indicator light in the button goes out.

#### Switching air recirculation on and off automatically

- Press the **CLIMATE** Infotainment button.
- Tap the **Extras** function key.
- Switch automatic air recirculation on or off by tapping the **Automatic air recirculation** function key.

If the check box in the function key is checked , automatic air recirculation is switched on.

#### What automatic air recirculation does

In automatic air recirculation mode, fresh air will enter the passenger compartment. If the system detects an increased concentration of pollutants in the outside air, it automatically switches to air recirculation. As soon as the pollutant level is back in the normal range, air recirculation is switched off.

Unpleasant odors cannot be detected by the system.

To keep the windows from fogging up, automatic air recirculation is **not** switched on automatically in certain circumstances.

### **WARNING**

**Stale air causes driver fatigue and reduces driver alertness, which can cause accidents, collisions and serious personal injury.**

- **Never use air recirculation mode over an extended period of time, since no fresh air will enter the passenger compartment.**
- **When the air conditioner is off and recirculation mode is on, condensation can quickly form on the windows and greatly reduce visibility.**
- **Always switch off recirculation mode when it is not needed.**

### **NOTICE**

**Do not smoke when air recirculation is switched on. Smoke drawn into the ventilation system can leave residue on the evaporator and on the dust and pollen active carbon filter, resulting in permanent odors whenever the air conditioner is switched on.**



 When backing up and while the automatic wiper/washer is operating, air recirculation is briefly activated to avoid unpleasant odors in the passenger compartment. This feature only works if automatic air recirculation is enabled ⇒ *Switching air recirculation on and off automatically.*

## Heated steering wheel

 Please first read and note the introductory information and heed the **WARNINGS** 

The heated steering wheel function only works when the engine is running or is drive-ready (hybrid). The steering wheel gets heated to about 77 °F (+25 °C) and holds the temperature there.

#### **Switching the heated steering wheel function on and off**

- Press the  button in the upper center console.
- **OR:** Press the button **CLIMATE** on the infotainment screen and the touch the  button to switch on or off.

#### **Automatic deactivation**

The heated steering wheel function switches off automatically, if:

- The engine is switched off.
- When the overall energy consumption is too high, like when too many devices and functions are activated in the vehicle.
- The heated steering wheel system malfunctions.



#### **WARNING**

**Certain medical conditions, such as paralysis and diabetes, and certain medications can increase the risk of serious burns when the heated steering wheel function is switched on.**

- **Never use the heated steering wheel function if you or your passengers are at risk of being burned because of a medical condition. Take regular breaks and get out of the vehicle, particularly on long trips. Consult your doctor for advice regarding your specific condition.**

# Refueling

## Introduction

---

In this section you'll find information about:

Indicator lights and fuel gauge

Refueling

Misfueling guard for diesel vehicles

Fuel capacities

Refueling checklist

The fuel filler flap is located on the rear right side of the vehicle ⇒ [fig. 1](#).

### More information:

- Exterior Views
- Fuel
- Selective catalytic reduction (AdBlue)
- Working in the engine compartment

### WARNING

**Improper refueling or handling of fuel is dangerous and can cause fire, explosion, and severe burns.**

- Always make sure that the fuel filler cap is screwed on all the way. This helps keep fuel from spilling out or evaporating.
- Fuel is highly flammable and explosive; it can cause severe burns and other severe injuries.
- Failure to shut the engine off while refueling and/or to insert the pump nozzle all the way into the fuel filler neck can cause fuel to overflow and to spray out. Fuel spray and overflowing fuel are dangerous because they can cause fire and serious personal injury.
- During fueling, the engine, and the ignition must be switched off for safety reasons.
- Never use a cellular telephone, CB radio, or other radio equipment while refueling. The electromagnetic radiation can cause sparks that can ignite fuel vapors and cause a fire.
- Never get back into your vehicle while refueling. If in exceptional circumstances you must get back in your vehicle while refueling, make certain that you close the door and touch metal to discharge static electricity before touching the filler nozzle again. This helps avoid the build-up of static electricity, which can cause sparks that can ignite fuel vapors released during refueling. Sparks can cause a fire while refueling.
- Never smoke or have an open flame (or sparks, cigarettes, or other smoldering objects) anywhere in or near your vehicle when refueling or filling a portable fuel container.
- Follow all safety instructions and procedures that apply at the service station where you refuel.
- Never spill fuel in the vehicle or the luggage compartment.



## WARNING

- Even if empty, portable fuel containers can leak and cause a fire and serious personal injuries, especially in a crash.
- If, under exceptional circumstances, you must transport a portable fuel container, please observe the following:

For your safety, we strongly recommend that you do not travel with a portable fuel container in your vehicle.

- Never fill a portable fuel container while it is anywhere in or on the vehicle (for example, in the luggage compartment or on the rear hatch). Static electricity can build up while filling and can ignite fuel vapors, causing a fire.
- Always place a portable fuel container on the ground before filling. Never spill fuel inside the vehicle or luggage compartment. Fuel vapors are highly flammable.
- Always keep the filler nozzle completely inside the portable container before and during filling.
- If filling a portable container made of metal, the filler nozzle must always be in contact with the container. This will help prevent static electricity from discharging and causing a fire.
- Always observe local and state or provincial laws about the use, storage, and transportation of portable fuel containers.
- Make certain that the portable fuel container meets industry standards, such as ANSI/ASTM F852-86.



## NOTICE

- Remove fuel spills from the vehicle immediately to help prevent damage to the paint, tires, and wheel housings.
- Refueling with gasoline when your vehicle has a diesel engine or refueling with diesel fuel when your vehicle has a gasoline engine can cause very serious and expensive engine and fuel system damage that is not covered by any Volkswagen Limited Warranty.
- If you put any amount of incorrect fuel in the fuel tank, do not start the engine under any circumstances. Immediately contact the nearest authorized Volkswagen dealer or authorized Volkswagen Service Facility for assistance. These fuels contain substances that can severely damage the fuel system and the engine if the engine is started.
- Vehicles with diesel engines must never be refueled or driven with gasoline, kerosene, heating oil, or other non-specified fuels that have not been expressly approved for use with the diesel engine. Other kinds of fuel will cause serious damage to the fuel system and the engine that is not covered by any Volkswagen Limited Warranty.



Fuels can pollute the environment. Spilled fuel must be collected and disposed of properly, following all applicable environmental regulations.



There is no emergency release for the fuel filler flap. Contact an authorized Volkswagen dealer or an authorized Volkswagen Service Facility for assistance if necessary.

## Indicator lights and fuel gauge

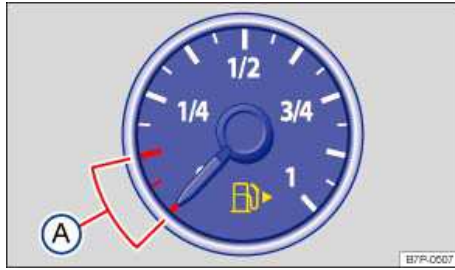

Fig. 304 In the instrument cluster: Fuel gauge for gasoline and diesel fuel.

ⓘ Please first read and note the introductory information and heed the WARNINGS ⚠

Lights up	Gauge position ⇒ fig. 304	Possible cause or meaning ⇒ ⚠	Proper response
🛢	Red range (arrow)	Fuel tank almost empty. Running on reserve	Time to refuel ⇒ ⌚.
		Fuel tank system malfunction.	Take the vehicle to an authorized Volkswagen dealer or an authorized Volkswagen Service Facility and have the system checked.
🚪		Fuel filler cap not properly closed.	Stop and closer fuel filler cap properly.

When the ignition is switched on, several warning and indicator lights come on briefly for a function check. They go out after a few seconds.

### Fuel filler cap not properly closed 🚪

If the indicator light 🚪 comes on or you see a text message in the instrument cluster display indicating that the fuel filler cap is not properly closed, stop the vehicle in a safe place and switch off the engine and the ignition.

Open the fuel filler flap and take the fuel filler flap off the filler neck. Then put the fuel tank cap back on the filler neck and screw it on clockwise until you clearly hear a clicking sound. Close the fuel filler flap.

After switching on the ignition, the indicator light  may stay on or the text message may still appear in the instrument cluster display, even if the fuel filler cap is now properly closed. This is normal and no reason to take your vehicle in for service.

If, however, the malfunction indicator light  also comes on, drive to your nearest authorized Volkswagen dealer or authorized Volkswagen Service Facility and have the fuel system and the engine checked.

### **WARNING**

**Driving with a fuel tank that is almost empty can lead to stalling in traffic, a collision, and serious personal injuries.**

- When the fuel tank is almost empty, fuel supply to the engine can be interrupted, especially when driving up an down hills. The interruption in fuel flow could stall the engine during a maneuver in difficult terrain and make you lose control of the vehicle.
- Steering and braking assistance as well as ESC and related systems will not work if the engine “sputters” or stalls due to lack of fuel.
- Always refuel when the tank is 1/4 full to reduce the risk of running out of fuel and stalling in traffic.

### **NOTICE**

- Failure to heed warning lights or text WARNINGS can result in vehicle damage.
- Never drive until the fuel tank is completely empty. The irregular fuel supply can cause the engine to misfire. This allows unburned fuel to get into the exhaust system and damage the catalytic converter or the diesel particulate filter.

 The small arrow next to the gas pump symbol in the fuel gauge shows the side of the vehicle with the fuel filler flap.

## Refueling

---

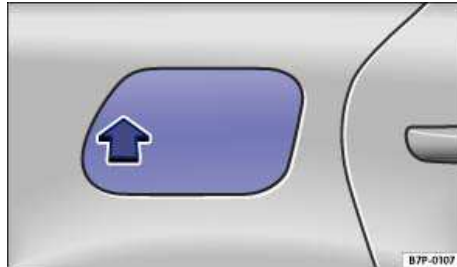

**Fig. 305** In the right rear fender: Opening fuel filler flap.

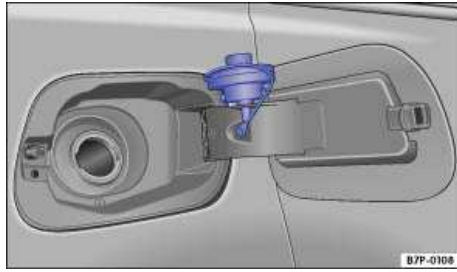

**Fig. 306** Fuel cap placed on the open fuel filler flap.

**ⓘ Please first read and note the introductory information and heed the WARNINGS ⚠**

**Before** refueling, always switch off the engine, the ignition and all mobile phones, and leave them switched off until refueling is complete.

#### **Opening the fuel filler cap**

- The fuel filler flap is located at the right rear of the vehicle.
- Push on the fuel tank flap in the right rear fender ⇒ [fig. 305](#) (arrow) and fold open.
- Unscrew the fuel filler cap counterclockwise remove. Use the receptacle on the filler flap hinge to hold the cap while refueling ⇒ [fig. 306](#).

#### **Refueling**

The correct fuel grade for your vehicle is listed on a sticker on the inside of the fuel filler flap

- The fuel tank is *full* when the automatic filler nozzle pump switches off the first time ⇒ ⚠.
- Do not try to add fuel after the pump stops! Topping off the tank in this way may fill the expansion space that the tank needs and cause fuel to overflow, for example, if it gets warmer outside.

#### **Closing the fuel filler cap**

- Screw the fuel cap clockwise onto the fuel filler neck until you hear it click into place.
- Close the fuel filler flap until you hear it latch shut. The fuel filler flap must be flush with the vehicle body.

### **⚠ WARNING**

**Spilled fuel can cause fires, explosions, burns, and other severe injuries.**

- **Always stop refueling once the pump nozzle switches off so that the tank does not overflow.**

### **ⓘ NOTICE**

**Remove fuel spills from all vehicle surfaces immediately to help prevent damage to the paint, tires, and wheel housings.**

 Fuel spills may pollute the environment.

## Misfueling guard for diesel vehicles



Fig. 307 With open fuel cap: Misfueling guard in the fuel filler neck.

**⚠ Please first read and note the introductory information and heed the WARNINGS ⚠**

The fuel filler neck of diesel vehicles is equipped with a misfueling guard ⇒ fig. 307. If you have problems inserting a fuel nozzle, first check to make sure you are using the correct diesel fuel. If you are, go to a pump with the standard diesel nozzle. The misfueling guard helps prevent filling the fuel tank of a diesel vehicle with gasoline, because the guard makes it difficult to insert any type of filler nozzle other than the type commonly used for diesel fuel.

Damaged, worn out, or incorrect nozzles, as well as other means of refueling (portable fuel containers, for example) will generally not open the misfueling guard and fuel from these sources cannot easily flow into the tank. Using these incorrect or non-standard nozzles to refuel your diesel vehicle can cause fuel spills, which can cause fires, explosions, burns, and other severe injuries.

The misfueling guard can generally only be properly opened with a correct nozzle from a standard diesel fuel pump. Under certain circumstances it may be necessary to turn the nozzle back and forth slightly with light pressure to open the misfueling guard. If the misfueling guard cannot be opened this way, see the nearest authorized Volkswagen dealer or authorized Volkswagen Service Facility and have the fuel system checked.

### **⚠ WARNING**

Spilled fuel can cause fires, explosions, burns, and other severe injuries.

- Do not refuel from devices other than correct, undamaged standard diesel fuel pump nozzles.
- Always stop refueling once the pump nozzle switches off so that the tank does not overflow.

### **ⓘ NOTICE**

- It is your responsibility to put the right fuel in your vehicle and any damage that results from using the wrong fuel is not covered under the Emissions warranties or any other Volkswagen Limited Warranty.
- If you put any amount of the wrong fuel in the fuel tank, do not start the engine under any circumstances. Immediately contact the nearest authorized Volkswagen dealer or authorized Volkswagen Service Facility for assistance.
- If diesel fuel should get on any rubber hose, it must be wiped off immediately. The same applies if diesel fuel gets onto other parts of the vehicle, especially paint, tires, or a plastic part. Wash the contaminated vehicle parts right away with soap and warm water to help prevent leaks and serious damage.



## NOTICE

- Never force a fuel nozzle in the misfueling guard. Forcing a fuel nozzle in the misfueling guard can damage it so that it can no longer help prevent misfueling.
- If you have problems inserting a diesel fuel nozzle, please check to make sure you are using the right kind of diesel fuel.
- If you must refuel with a non-standard diesel fuel nozzle, an adapter is available from Volkswagen to allow refueling. Contact an authorized Volkswagen dealer or authorized Volkswagen Service Facility for assistance. Only use an adapter approved by Volkswagen for your vehicle.
- Remember that the nozzle on a portable fuel container will generally not open the misfueling guard. If you must refuel with a portable fuel container in an emergency, you can pour diesel fuel very slowly from a portable container into the fuel filler neck of your vehicle. The fuel will flow slowly past the misfueling guard and into the tank.

## Fuel capacities

 Please first read and note the introductory information and heed the WARNINGS 

	Fuel tank capacity
<b>Hybrid drive vehicle</b>	26.41 gal (100.0 l) of which about 3.17 gal (12.0 l) reserve
<b>Gasoline engines</b>	26.41 gal (100.0 l) of which about 3.96 gal (15.0 l) reserve
<b>Diesel engines</b>	26.41 gal (100.0 l) of which about 3.17 gal (12.0 l) reserve

## Refueling checklist

 Please first read and note the introductory information and heed the WARNINGS 

The engine compartment of any motor vehicle is a hazardous area. Never do any work on the engine or in the engine compartment unless you.

- Know exactly how to carry out the job,
- have the correct technical information and the proper tools and supplies, and
- are familiar with the necessary safety precautions *Working in the engine compartment*.

## Checklist

---

If you are uncertain in any way, have the work done by an authorized Volkswagen dealer or authorized Volkswagen Service Facility. Serious personal injury may result from improperly performed work. Make sure that you check the following items regularly. The best thing is to check them every time you refuel:

- ✓ Windshield washer fluid level ⇒ *Windshield wiper and washer*
  - ✓ Engine oil level ⇒ *Engine oil*
  - ✓ Engine coolant level ⇒ *Engine coolant*
  - ✓ Brake fluid level ⇒ *Braking and parking*
  - ✓ Tire pressure ⇒ *Tires and wheels*
  - ✓ Vehicle lighting necessary for driving safety:
    - Turn signals
    - Parking lights, low beams and high beams
    - Taillights
    - Brake lights
    - License plate light
- 

Information regarding replacing light bulbs ⇒ *Replacing light bulbs.*



### **WARNING**

**Disregarding the safety-related checklist may lead to accidents and injuries.**

- **Please note and follow the points listed in the checklist.**

# Fuel

## Introduction

---

In this section you'll find information about:

Gasoline

Gasoline additives

Diesel fuel

The correct fuel grade for your engine is shown on a sticker located on the inside of the fuel filler flap  
⇒ [fig. 306](#).

Bad or poor quality fuel reduces operating performance, efficiency and service life of the engine. If you notice any symptoms like rough engine idle or performance or "bucking", immediately reduce the vehicle speed, accelerate slowly and keep the engine speed in the middle of the rpm range. Avoid high rpm and rapid acceleration. If these symptoms should appear right after refueling, switch off the engine. In both cases contact an authorized Volkswagen dealer or an authorized Volkswagen Service Facility to have the engine checked.

### More information:

- ⇒ Booklet *Warranty and Maintenance*
- Refueling
- Engine control and exhaust system

 <b>WARNING</b>
<p><b>Improper refueling or handling of fuel can cause fire, explosion, and severe burns.</b></p> <ul style="list-style-type: none"><li>• Fuel is highly explosive and flammable and can cause severe burns and other injuries.</li><li>• Heed applicable safety warnings and obey local fuel handling regulations.</li><li>• Always make sure the fuel cap is screwed on all the way. This keeps fuel from spilling out and from evaporating.</li><li>• Failure to shut the engine off while refueling and/or to insert the pump nozzle fully into the vehicle's filler neck could cause fuel overflow and fuel spray. Fuel spray and overflowing fuel are dangerous because they can cause fire or serious injury.</li><li>• For safety reasons, the engine must be turned off when refueling.</li><li>• Never get back into your vehicle while refueling. If in exceptional circumstances you must get back in your vehicle while refueling, make certain that you close the door and touch metal to discharge static electricity before touching the filler nozzle again. Static electricity can cause sparks that can ignite fuel vapors released during refueling.</li></ul>

## Gasoline

---

 Please first read and note the introductory information and heed the WARNINGS 

### Octane rating

Octane rating indicates a gasoline's ability to resist engine damaging "knock" caused by pre-ignition. Using the correct grade of gasoline is very important to help prevent engine damage and loss of engine performance.

The recommended gasoline octane rating for your engine is listed on a label inside of the fuel filler flap. This rating may be specified according to AKI (CLC) or RON (ROZ) standards.

If unleaded Premium grade gasoline is specified for your vehicle, then Volkswagen recommends using TOP TIER Detergent Gasoline with a minimum octane rating of 91 AKI (95 RON). For more information on TOP TIER Detergent Gasoline, please go to the official website (<http://www.toptiergas.com>).

The gasoline grades most commonly sold in the United States and Canada have the following octane ratings, which can usually be found on the filler pump:

- Premium grade: 91 to 96 AKI
- Regular grade: 87 to 90 AKI

### Unleaded gasoline

Unleaded gasoline is available throughout the USA and Canada. Volkswagen recommends that you do not take your vehicle to places where unleaded gasoline may not be available.

### Gasoline containing alcohol or MTBE

You may use unleaded gasoline blended with alcohol or MTBE (methyl tertiary butyl ether), commonly referred to as oxygenated fuels, if the blended mixture meets the following criteria:

#### Blends of gasoline and methanol (wood alcohol or methyl alcohol):

- Anti-Knock Index (AKI) must be 87 or higher.
- Blend must contain no more than 3% methanol.
- Blend must contain more than 2% co-solvents.

#### Blends of gasoline and ethanol (grain alcohol or ethyl alcohol):

- Anti-Knock Index (AKI) must be 87 or higher.
- Blend must contain no more than 15% ethanol.

#### Blends of gasoline and MTBE:

- Anti-Knock Index (AKI) must be 87 or higher.
- Blend must contain no more than 15% MTBE.

### Seasonally adjusted gasoline

Many fuels are blended especially for winter or summer conditions. When seasons change, Volkswagen suggests that you buy fuel at busy stations where the seasonal adjustment is more likely to be made earlier.

### WARNING

Starting fluids can explode and cause a run-away vehicle condition.

- Never use starting assist fluids.

### NOTICE

- Never use fuel with an octane rating lower than 87 AKI/91 RON. Using lower octane fuel may cause expensive engine damage.
- Never use leaded gasoline! Leaded gasoline will severely damage your vehicle's catalytic converter.

- Methanol-blended fuels that do not meet the criteria listed above may cause corrosion and may damage plastic and rubber parts in the fuel system.
- Never use fuels that contain lead or other metals (check listing on the fuel pump). Even lead replacement gasoline (LRP fuels) contain metallic additives in high concentrations. They can damage the engine.
- Do not use fuels that fail to meet the criteria above, or with contents that cannot be identified.
- If you cannot tell whether a particular fuel blend meets the criteria above, ask your service station or its fuel supplier. If you notice a loss of fuel economy or drivability and performance problems using one of these fuel blends, we recommend that you switch to unblended fuel.
- Using fuels that are different from those specified above can damage your vehicle's engine and fuel system and cause performance problems.
- Damage to the engine and fuel system and performance problems caused by using fuels that are different from those specified above or buy using "starting assist fluids" are not the responsibility of Volkswagen and are not covered under the Emission warranties or any other Volkswagen Limited Warranty.



Even a single tank full of leaded fuel can do major damage to the catalytic converter and degrade its effectiveness in reducing polluting emissions.



If you notice a loss of fuel economy or drivability and performance problems using one of these fuel blends, we recommend that you switch to unblended fuel. Never use fuel line antifreeze offered for gasoline engines.

## Gasoline additives

**ⓘ Please first read and note the introductory information and heed the WARNINGS ⚠**

Additives are used to improve the quality of the gasoline.

Fuel quality impacts the operating performance, efficiency and service life of the engine. Therefore, use high quality gasoline that is already blended by the fuel supplier with suitable gasoline additives that do not contain metal. The additives provide corrosion protection, clean the fuel system, and help prevent deposits on the engine.

Volkswagen recommends TOP TIER Detergent Gasoline. For more information on TOP TIER Detergent Gasoline, please go to the official Web site <http://www.toptiergas.com>.

If quality gasoline with additives that do not contain metal is not available or engine malfunctions occur, you should add the required additives while refueling ⇒ ⓘ.

Not all gasoline additives are effective. Using the wrong additives can cause significant and expensive damage to the engine and the catalytic converter. Never use additives that contain metal. Please note that metal can be included in some aftermarket gasoline additives that are available to be added to gasoline during or after refueling to help improve knock resistance or increase the octane rating.

Volkswagen recommends using only additives approved by Volkswagen. Appropriate additives as well as instructions on how to use them are available from your authorized Volkswagen dealer or authorized Volkswagen Service Facility. Do not add any other gasoline additives.



### NOTICE

**You can damage the engine by using incorrect additives.**

- Using incorrect gasoline additives can cause extensive engine damage as well as damage to the catalytic converter.

- If you must fuel your vehicle with gasoline whose octane rating is too low, only drive with the engine speed in the middle of the rpm range and with low engine load. Avoid high rpm and heavy engine load. Otherwise, the engine could be damaged. Refuel your vehicle with gasoline with the required octane rating as soon as possible.
- Do not use fuel that is labeled at the pump as containing metal. Lead replacement fuel contains high concentrations of metallic additives. Engine damage could result.
- Fueling your vehicle just one time with leaded fuel or fuel that contains other metallic additives can affect the performance of the catalytic converter and cause extensive damage to it.

## Diesel fuel

---

 Please first read and note the introductory information and heed the **WARNINGS** 

Always use only Ultra Low Sulfur Diesel (ULSD) fuel No. 2 ⇒ .

The ULSD must always meet ASTM D-975 specification ⇒ .

“ULSD” should be clearly marked on the pump. Before filling your vehicle, please always make sure you are using ULSD. According to Federal regulations ULSD is the only diesel fuel type allowed for use in your vehicle.

Using diesel fuel with concentrations of methyl ester biodiesel higher than 5% (B5), such as B11, B20, or B100 when B5 biodiesel is available, is contrary to the terms of your New Vehicle Limited Warranty and is strictly prohibited.

ULSD diesel fuel may not be available outside the USA and Canada. Be sure to check availability before traveling to other countries.

### Winter diesel

At temperatures below 20 °F (-7 °C), wax separation in ULSD occurs. Wax may clog the fuel filter or tank filter and keep the engine from running.

To help prevent the filter from being clogged with wax, the fuel filter in your vehicle is heated with warm fuel when the engine is running (filter preheating system). Heating the fuel filter makes it possible to use your vehicle with ULSD down to about -10 °F (-24 °C).

If you expect temperatures below +5 °F (-15 °C) ask your fuel dealer if their ULSD is sufficiently winterized.

If non-winterized or insufficiently winterized diesel fuel has already thickened to the point that the engine will not start, move the vehicle to a heated garage or workshop until it has warmed up.

Cold diesel engines normally produce louder noises during winter conditions than during warmer periods. In addition, the exhaust gases may be light blue in color until the engine has warmed up. The exhaust gas volume varies depending on the outside temperature.

Do not let your diesel engine idle unnecessarily after a cold start. Driving off slowly will shorten the warm-up period.

### Illinois registered vehicles

Biodiesel is a domestically produced, clean-burning and renewable partial substitute for conventional (petroleum) diesel fuel.

Your vehicle was originally designed to run on “ULSD” – Ultra Low Sulfur Diesel fuel [ASTM D-975 standard Grade No. 2-D (S15)] that complies with ASTM D-975 specifications and permits up to a maximum blend of 5 % biodiesel (B5).

Due to Illinois state tax incentives or regulations for biofuels, biodiesel blends of B5 or less may not be available in Illinois. *However, we want to assure you that Volkswagen will continue to honor the terms and conditions of the Volkswagen Limited Warranties that came with your vehicle.* Use only Biodiesel from high quality sources, certified by the BQ-9000 label at the fuel station and complying to ASTM D 7467 S15, B6 to B20.

Using diesel fuel with concentrations of methyl ester biodiesel higher than 20 % (B20), such as B100 is still contrary to the terms of your Emission warranties or any other Volkswagen Limited Warranty and remains strictly prohibited.

Biodiesel blends (up to B20) may be used in your Illinois registered TDI® Clean Diesel vehicle; however, please be aware that biodiesel has characteristics that are different from other kinds of fuel, especially petroleum-based fuels.

Biodiesel can attract water and also deteriorate with age. Small amounts of biodiesel can get into the engine oil, but unlike petroleum diesel, it does not evaporate over time. This can cause the oil level in the engine to rise and can affect the quality of the oil.

- Routinely check the engine oil level. A good time to do this is when you refuel, especially if you regularly do a lot of short distance or stop-and-go driving. This will help you see if the engine oil level is getting higher. (A rising oil level beyond the maximum indicator means an oil change is needed due to the dilution of the oil in the system; a potential characteristic of biodiesel use) ⇒ page 590, *Checking the engine oil level and adding oil*.
- If you ever notice that the engine oil level has risen or is above the maximum indicator, contact your authorized Volkswagen dealer, authorized Volkswagen Service Facility or Volkswagen Customer CARE to schedule an oil change – regardless of the time or mileage that has elapsed since you last had an oil change performed.
- Continue to follow the oil change intervals found in the Warranty and Maintenance booklet that came with your vehicle, and use only engine oil that expressly complies with Volkswagen quality standard VW 507 00.
- Refuel only at trusted, commercial fueling stations that are located near main highways. These stations are more likely to have “fresh” biodiesel fuels that have not aged significantly.
- If your vehicle will be in storage (or not driven) for several weeks or months, please completely fill the fuel tank. If possible, fill the tank with Ultra Low Sulfur Diesel fuel [ASTM D-975 standard Grade No. 2-D (S15)].

If you have additional questions about your Illinois registered TDI® Clean Diesel vehicle, please call or write to us at:

**Volkswagen of America, Inc.**

Attn: Customer CARE

3800 Hamlin Road, Auburn Hills, MI 48326

Tel.: 1-800-444-8982

**⚠ WARNING**

**Starting fluids can explode and cause a run-away vehicle condition.**

- **Never use starting assist fluids.**

**! NOTICE**

- **The vehicle's diesel engine was designed solely for use with ULSD fuel. For this reason, never use gasoline, heating oil, or other fuels that have not been expressly approved for use with the diesel engine. These fuels contain substances that will severely damage the fuel system and the engine. Such damage will not be covered by any Volkswagen Limited Warranty.**
- **If you put any amount of the incorrect fuel in the fuel tank, do not start the engine under any circumstances. Immediately contact the nearest authorized Volkswagen dealer or authorized Volkswagen Service Facility for assistance.**
- **If diesel fuel should get on any rubber hose, it must be wiped off immediately. The same applies if diesel fuel gets onto other parts of the vehicle, especially paint, tires, or a plastic part. Wash the contaminated vehicle parts right away with soap and warm water to help prevent leaks and serious damage.**

- Damage to the engine and fuel system and performance problems caused by using fuels that are different from those specified above or by using “starting assist fluids” are not the responsibility of Volkswagen and are not covered under the Emission warranties or any other Volkswagen Limited Warranty.
- The vehicle is warranted to run on diesel fuel containing methyl ester biodiesel in concentrations of 5 % or less. Never use methyl ester biodiesel in blend levels higher than 5 % (5 % methyl ester blends are sometimes designated or labeled as B5) unless your vehicle is registered in Illinois. The properties of methyl ester biodiesel blends in levels greater than 5% will void coverage for related engine damage under the Emission warranties or any other Volkswagen Limited Warranty, *unless* your vehicle is registered in Illinois.
- Biodiesel especially in concentrations higher than B5, can attract water and also deteriorate with age. Small amounts of biodiesel can get into the engine oil, but unlike petroleum diesel, it does not evaporate over time. This can cause the oil level in the engine to rise and can affect the quality of the oil and if not detected and remedied promptly, will ultimately result in engine damage.



# Selective catalytic reduction (AdBlue®)

## Introduction

---

In this section you'll find information about:

- Warning and indicator lights
- AdBlue information
- Refilling AdBlue

AdBlue® is the brand name of a Diesel Exhaust Fluid (DEF) that is a chemical reactant to reduce nitrogen oxide (NOx) exhaust emission from your Clean Diesel engine. Volkswagen recommends AdBlue, but you can use any Diesel Exhaust Fluid that expressly conforms to International Organization for Standardization specification **ISO 22241-1**. Using a DEF that does not meet the requirements of ISO 22241 can seriously damage your vehicle's engine.

The fill level of AdBlue should be checked every time the vehicle is serviced ⇒ Booklet *Warranty and Maintenance*.

### More information:

- Luggage compartment
- Fuel
- Parts, accessories, repairs and modifications

### WARNING

**If the AdBlue fill level is too low, the vehicle cannot be restarted after the ignition was switched off. It is also not possible to jump-start or emergency start the vehicle!**

- Refill AdBlue when the AdBlue fuel range falls to about 600 miles (1000 km).
- Never let the AdBlue tank run dry.

### WARNING

**AdBlue is an irritating and corrosive fluid that can harm skin, eyes, mucous membranes, and respiratory organs.**







- If AdBlue gets into the eyes, flush them thoroughly with large amounts of clean water for at least 15 minutes; medical attention is recommended.
- If AdBlue is swallowed, immediately rinse the mouth for at least 15 minutes with plenty of water. Do not induce vomiting unless instructed to do so by a medical professional. Get medical attention immediately.



### NOTICE

- AdBlue corrodes surfaces such as painted vehicle components, plastics, clothing and carpets. Remove spilled AdBlue immediately with a wet cloth and plenty of cold water.
- Remove crystallized AdBlue with warm water and a sponge.

## Warning and indicator lights

☐ Please first read and note the introductory information and heed the WARNINGS ⚠ on page 544.

Lights up	Possible cause or meaning ⇒ ⚠	Proper response
	<b>No engine restart possible!</b> AdBlue fill level too low.	Stop the vehicle at a safe and appropriate place with level pavement and refuel AdBlue
together with 	<b>No engine restart possible!</b> AdBlue system malfunction.	Have the system checked by an authorized Volkswagen dealer or an authorized Volkswagen Service Facility.
	AdBlue level is low.	Refill the AdBlue tank within the indicated number of miles or kilometers. Volkswagen recommends going to an authorized Volkswagen dealer or an authorized Volkswagen Service Facility.
together with 	AdBlue system malfunctioning or not filled standard AdBlue.	Have the system checked by an authorized Volkswagen dealer or an authorized Volkswagen Service Facility.
	AdBlue level is low.	Refill the AdBlue tank within the indicated number of miles or kilometers. Volkswagen recommends taking the vehicle to an authorized Volkswagen dealer or an authorized Volkswagen Service Facility.
	AdBlue system malfunction-	Have the system checked by an

Lights up	Possible cause or meaning ⇒ 	Proper response
together with 	ing or not filled standard AdBlue.	authorized Volkswagen dealer or an authorized Volkswagen Service Facility.

When the ignition is switched on, several warning and indicator lights come on briefly for a function check. They go out after a few seconds.

** WARNING**

Failure to heed warning lights and instrument cluster text messages can cause the vehicle to break down in traffic and result in a collision and serious personal injury.

- Never ignore warning lights or text WARNINGS.
- Always stop the vehicle as soon as it is safe to do so.

** NOTICE**

Failure to heed warning lights or text WARNINGS can result in vehicle damage.

## AdBlue information

** Please first read and note the introductory information and heed the WARNINGS **



In vehicles with selective catalytic reduction, a special urea solution (AdBlue) is injected into the exhaust system ahead of the catalytic converter in order to reduce nitrogen oxide emissions.

AdBlue is stored in a separate tank of the vehicle and should be refilled under normal driving conditions during service according to the maintenance schedule. The AdBlue tank holds slightly less than 5 gallons (20 liters).

AdBlue consumption depends on the individual driving style, system operating temperature, and outside air temperature. Therefore in rare cases AdBlue may have to be refilled between service events.

Starting with a remaining range of about 1500 miles (2400 km), a reminder to refill AdBlue is displayed in the instrument cluster ⇒ *Refilling AdBlue*. If you ignore the last refill reminder, it is impossible to start the engine again after it is switched off ⇒ *Warning and indicator lights*.

Volkswagen recommends that you have the AdBlue tank refilled by an authorized Volkswagen dealer or an authorized Volkswagen Service Facility. If no authorized Volkswagen dealer or authorized Volkswagen Service Facility or other qualified workshop is available, you should refill at least 1.5 gallons (5.7 liters) of AdBlue (3 AdBlue bottles). Refill only the type of AdBlue that Volkswagen has explicitly approved for your vehicle.

If warning lights  and  both come on together, there is a malfunction. Volkswagen recommends that you take the vehicle to the closest qualified workshop.

AdBlue® is a registered trademark of the German Association of the Automotive Industry (VDA) in the United States, Germany, the European Union and in other countries. AdBlue meets International Organization for Standardization specification ISO 22241-1.

## Refilling AdBlue

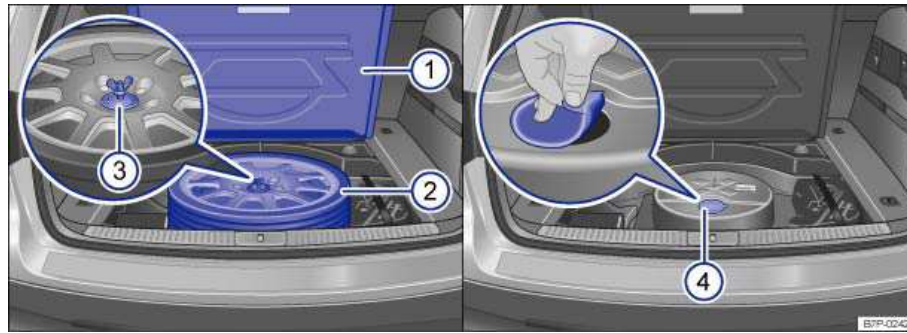

Fig. 308 Luggage compartment with collapsible spare tire and AdBlue tank.

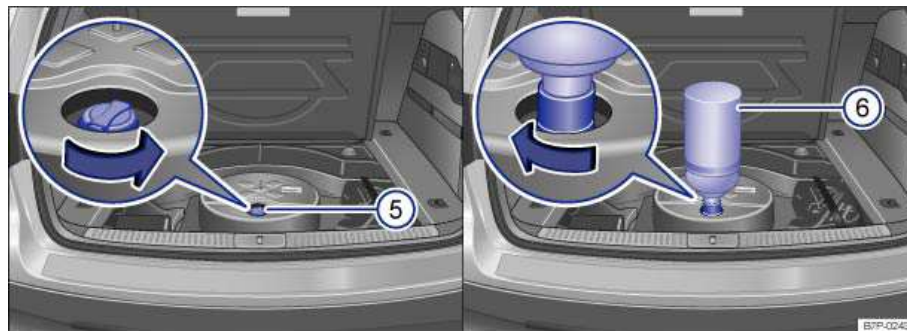

Fig. 309 AdBlue tank with filler neck cap and refill container.

⚠ Please first read and note the introductory information and heed the WARNINGS ⚠

Key to ⇒ fig. 308 and fig. 309:

- (1) Luggage compartment floor.
- (2) Collapsible spare tire.
- (3) Fastening screw with washer.
- (4) Plug.
- (5) Cap on the tank filler neck.
- (6) AdBlue refill container.

When refilling AdBlue, the vehicle must be parked on a level surface, not on an incline or with the wheels on one side up on the curb. If the vehicle is not on level ground, the gauge that shows the fill level may not register the added quantity.

### Opening the tank filler neck

- Open the rear hatch.

- Fold up the luggage compartment floor panel ⇒ [fig. 308 \(1\)](#) and hook it open or, if you have a reversible luggage compartment floor panel, take this out
- Take out the collapsible spare tire (2)- Unscrew the fastening screw (3) with washer counterclockwise and take out the collapsible spare tire.
- Pull off the plug (4) in the spare tire well.
- Unscrew the tank filler neck cap ⇒ [fig. 309 \(5\)](#) counterclockwise and remove.

### Refilling AdBlue

**Only use Volkswagen-approved AdBlue or any Diesel Exhaust Fluid that expressly conforms to International Organization for Standardization specification ISO 22241-1. Using a DEF that does not meet the requirements of ISO 22241-1 can seriously damage your vehicle's engine. Only use fluid in original, unopened packaging.**

- Read and heed the information provided by the AdBlue refill manufacturer ⇒ ⓘ.
- Note the expiration date.
- Unscrew the cap of the refill container.
- Vertically insert the neck of the refill container (6) into the tank filler neck and turn clockwise to hand-tighten.
- Press the refill container down into the tank filler neck and hold it there.
- **Add at least 1.5 gallons (5.7 liters) of AdBlue which is 3 refill bottles.** Adding a smaller amount is not sufficient.
- Wait until the contents of the refill container has flowed into the AdBlue tank. Do not squeeze or damage the refill container!
- Unscrew the refill container counterclockwise and lift it out carefully ⇒ ⓘ.
- AdBlue stops flowing from the refill bottle when the AdBlue tank is completely full.

### Closing the fuel filler neck

- Screw in the fuel filler neck cap (5) clockwise until the cap locks into place.
- Put the plug ⇒ [fig. 308 \(4\)](#) back in the spare wheel recess and make certain it is properly placed and secure.
- Put the collapsible spare tire (2) back in the spare wheel recess and secure it with the fastening screw (3) and washer.
- Unhook the luggage compartment floor panel (1) and fold down or, if you have a reversible luggage compartment floor panel, put this back in ⇒ *Luggage compartment*.

### Things to do before driving again

- After refilling, switch on **only** the ignition.
- Leave the ignition switched on for at least 30 seconds so that system can detect the refill.
- Do not start the engine for 30 seconds!

### WARNING

**Store AdBlue only in its closed original container and in a safe place.**

- **To reduce the risk of poisoning, never keep AdBlue in empty food or beverage containers that might mislead someone into drinking from them.**
- **Always store AdBlue outside the reach of children.**



## NOTICE

- Use only AdBlue® or any Diesel Exhaust Fluid that expressly conforms to International Organization for Standardization specification ISO 22241-1. Using a DEF that does not meet the requirements of ISO 22241-1 can seriously damage your vehicle's engine.
- Never mix water or any other substances or additives with AdBlue. Damage caused by such additives will not be covered by any Volkswagen Limited Warranty.
- Never put AdBlue into the diesel fuel tank! Otherwise the engine may be damaged!
- Do not carry a refill container in the vehicle all the time or routinely. Due to temperature fluctuations and damage, the container could start leaking and the AdBlue could damage the vehicle interior.



Dispose of the refill container in an environmentally-responsible manner.



Appropriate AdBlue refill containers can be obtained from an authorized Volkswagen dealer or an authorized Volkswagen Service Facility.

# Some basics

## Introduction

---

In this section you'll find information about:

- Rollover warning
- Before driving off-road
- General rules and good driving practices
- Technical terms explained
- Useful off-road driving equipment
- Safety and off-road driving

Your vehicle can be driven on and off-road. In this chapter you will find important information on driving your vehicle. It is very important to review this chapter before taking your vehicle off-road.

Driving off the beaten path is challenging - for the driver, the passengers, and the vehicle itself.

It requires special knowledge and skills different from those needed for highway driving. Successful off-roading comes from a combination of theory and practice. This includes knowing the right way to handle the expected and the unexpected ⇒ .

Safety must always have top priority. Never overestimate your own abilities or underestimate the difficulties that come with driving off-road. Never let determination get the better of your common sense. If the going gets too difficult, turn back and find a better route to your destination.

The wide range of terrain you can come up against, and the many risks and dangers the terrain may hide, make it impossible to foresee and deal in this Manual with every conceivable off-road situation you may face. For this reason, it is vital for you to know what lies ahead and evaluate possible dangers before trying to drive over difficult or unfamiliar terrain.

The vehicle is not designed for trips with "an expedition-like character".

### **More information:**

- Driving instructions
- Adjusting the seating position
- Safety belts
- Off-road driving situations



## WARNING

Inadequate experience and knowledge of the demands of off-road driving can lead to critical situations and cause serious personal injury.

- Never take routes or risks that could put you or your passengers in danger. If you cannot go on, or have doubts about the safety of your route, turn back and take a new route.
- The intelligent technology of the vehicle cannot change the laws of physics. Despite the ABS, adverse terrain can cause instability through blocked wheels – for example, if you brake hard when driving on a loose gravel road. Difficult terrain may also prevent the ESC from doing its job.
- Never operate the vehicle at the limit of its performance ability. Always leave a good safety margin.
- To reduce the risk of loss of control and serious personal injury, never use the cruise control when driving off-road.
- Even terrain that looks easy can be difficult and dangerous, putting you and your passengers in a critical situation. It is often best to check an area out on foot first.
- Drive with special care and think ahead in off-road terrain. If you drive too fast, or fail to maneuver the vehicle properly, you could cause personal injury and damage the vehicle.
- Never drive faster than is appropriate for the prevailing terrain and the road, traffic, and weather conditions.
- Never drive too fast across embankments, ramps, or slopes. The vehicle could become airborne. If that happens, you will not be able to steer and can lose control.
- If your vehicle becomes airborne, always keep the front wheels pointing straight ahead. If the wheels are not pointing straight ahead when the vehicle lands, it could roll over.
- Never allow people to stand in front of or behind the vehicle if you have put items such as stones or pieces of wood under the wheels to improve traction on slippery ground. Spinning wheels can turn these items into dangerous flying objects causing serious personal injury.
- Even areas that look harmless can be dangerous. Potholes, ditches, trenches, drop-offs, different kinds of obstacles, and soft or swampy ground often cannot be seen and can be partially or fully covered by water, grass, branches, or other things. Driving over such terrain can cause accidents and severe injuries. Before crossing an unknown area, carefully explore the route you plan to take on foot.



## WARNING

Never drive off-road if you are low on fuel. Too little fuel in the tank can cause an accident and serious injuries. You can also run out of fuel in a remote area where getting help is difficult or impossible.

- When the fuel tank is almost empty, fuel supply to the engine can be interrupted, especially when driving over bumps, across slopes, and up and down hills. The interruption in fuel flow could stall the engine during a maneuver in difficult terrain and make you lose control of the vehicle.
- Steering and braking assistance as well as ESC and related systems will not work if the engine “sputters” or stalls due to lack of fuel. This can cause loss of vehicle control, especially in difficult terrain.
- Always refuel when the tank is 1/4 full to reduce the risk of running out of fuel.



## NOTICE

If the power sunroof or the windows are open when it rains or snows, the interior of the vehicle will get wet and the vehicle may be damaged. Always keep the windows and the power sunroof closed when driving off-road.



## Rollover warning

---

☐ Please first read and note the introductory information and heed the WARNINGS ⚠

A vehicle's **center of gravity** affects its rollover characteristics. Since vehicle has higher ground clearance for off-road driving, its center of gravity is also higher than that of "standard" passenger cars. The higher center of gravity increases the risk of vehicle rollover while driving. Always keep this in mind when driving. Heed the safety information and warnings in this Manual.

### WARNING

Utility vehicles have a significantly higher rollover rate than other types of vehicles.

- In a rollover crash, an unbelted person is significantly more likely to die than a person wearing a safety belt.
- Your vehicle has a higher center of gravity and an increased risk of rollover while driving than a standard passenger vehicle that is not suitable for occasional off-road use.
- Never drive too fast, particularly through curves, and never attempt extreme driving maneuvers.
- Always adjust your speed and driving style to road, terrain, traffic, and weather conditions.
- Transporting luggage or other objects on top of your vehicle raises the center of gravity and can further increase the risk of rollover.
- Always avoid driving crosswise on a slope ⇒ *Driving crosswise on a slope*.
- If stopped crosswise on a slope, never get out of the vehicle using the doors that face downhill. The combined center of gravity of the vehicle and its contents (passengers and load) can shift, causing the vehicle to tip over and roll down the slope. Always exit the vehicle calmly using the doors that face uphill ⇒ *Driving crosswise on a slope*.

## Before driving off-road

---

☐ Please first read and note the introductory information and heed the WARNINGS ⚠

### Checklist: Review before every off-road trip!

For your own safety and that of your passengers, carry out each of the following steps in the order listed before every off-road trip ⇒ ⚠:

- ✓ Inform yourself thoroughly before exploring nature and the terrain you plan to visit.
- ✓ Do not plan extensive day trips. Consider the increased fuel consumption during off-road driving.
- ✓ Fill the fuel tank completely. Off-road driving consumes significantly more fuel than driving on the road.
- ✓ Check whether the tires are suitable for the off-road trip you are planning. For difficult terrain, always use special off-road tires.
- ✓ Check, and if necessary correct, the cold tire inflation pressure in all tires, including the collapsible spare tire (if any).
- ✓ Fill engine oil up to the MAX mark so the engine can be properly lubricated. This is especially important when driving through potholes and up and down hills.
- ✓ Completely refill the windshield washer reservoir with water and window washer fluid.
- ✓ Install a towing eye in the front and back of the vehicle. Once the vehicle gets stuck, it may no longer be possible to install a towing eye.

- ✓ Check the vehicle tool kit. Add tools and other gear based on the special requirements of the trip you will be taking ⇒ *Useful off-road driving equipment.*
- ✓ Stow luggage as low and flat as possible in the vehicle. Safely secure all loose objects.

---

### Before driving off-road the first time

Before you drive your vehicle off-road, we urge you to take an appropriate off-road driving course. Taking a course is especially important if you have little or no experience driving off-road. Even more experienced off-roaders can benefit from an off-road driving course.

A good course can show you how to handle the vehicle in a wide range of off-road situations and how to more safely deal with difficult terrain. Driving off-road demands a different attitude and very different skills compared with highway driving. Your safety and that of your passengers will depend on your knowledge, skill, and caution as a driver ⇒ ⚠.

 <b>WARNING</b>
<b>Disregarding the safety-related checklist may lead to accidents and serious personal injuries.</b>
<ul style="list-style-type: none"><li>• Always review and follow the checklist above. Follow commonly accepted safety practices and use common sense.</li><li>• All occupants must sit properly and wear safety belts whenever the vehicle is moving.</li></ul>

---

## General rules and good driving practices

📖 Please first read and note the introductory information and heed the **WARNINGS** ⚠

### Off-road rules of conduct

Always be responsible and respect the environment when driving off-road. Driving through undergrowth and over meadows can destroy areas where animals live.

- Only drive where it is permitted.
- Keep noise and dust to a minimum.
- Leave nature as you found it.
- Always stay on designated trails and paths.
- Avoid sensitive natural habitats.
- Yield to drivers who are driving uphill or passing.

### Good driving practices

Special rules apply to off-road driving ⇒ ⚠:

- Never drive off-road alone. At least 2 off-road vehicles should travel together. Unexpected situations can occur. For this reason, take along the equipment you need to call for help in case of an emergency.
- Stop and explore the route on foot wherever necessary and always before traveling over difficult trails or terrain.
- Drive over hill crests slowly. Otherwise, the vehicle can tip and be damaged and disabled.
- Drive slowly through difficult terrain segments. On slippery surfaces, upshift and keep the vehicle moving.
- Look for terrain that is firm and stable. Off-road ground is frequently soft, and the tires can sink into it. This reduces ground clearance and fording depth.
- Even at low speeds, always follow other vehicles at a safe distance. If the first vehicle suddenly gets stuck, the second vehicle can still stop in time without getting stuck as well.

## **⚠ WARNING**

Off-road driving can be dangerous, can lead to accidents, vehicle damage, stranding in remote areas, and serious personal injury.

- Never drive too fast or for terrain and weather conditions.
- Always adjust your speed and driving style to road, terrain, traffic, and weather conditions.
- Always avoid sudden, sharp maneuvers that increase the risk of loss of vehicle control or getting stuck.
- When driving off-road look and think ahead, expect the unexpected.
- To reduce the risk of loss of control and serious personal injury, never use the cruise control when driving off-road. Cruise control is designed for highway use. It is completely unsuitable for off-road situations and can even be dangerous when used off-road.

## **! NOTICE**

Always make sure the vehicle has enough ground clearance. Severe damage to the underbody can occur if the vehicle bottoms out. The damage could disable the vehicle and leave you stranded.



"Tread lightly" is an educational program designed to increase public awareness of land use regulations and responsibilities in our nation's wilderness areas. Volkswagen supports the U.S. Forest Service and the Bureau of Land Management in encouraging you to preserve our national forests and other public and private lands by "treading lightly".

## Technical terms explained

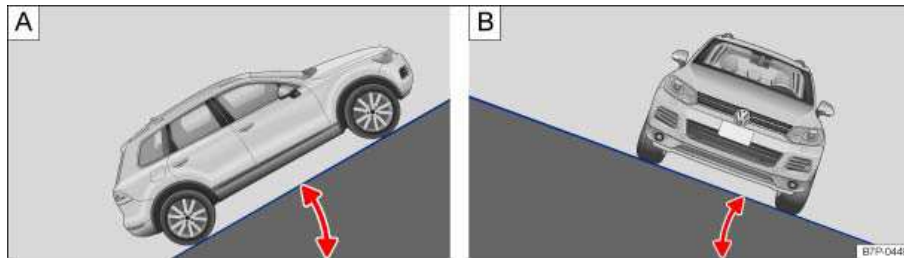

Fig. 310 Illustration of grade (gradient angle) A and lateral angle B.

**📖 Please first read and note the introductory information and heed the WARNINGS ⚠**

**The technical data in the table below only apply to ideal conditions. The values were determined on flat, firm, and non-slippery road surfaces and under dry weather conditions.**

Changes in vehicle load and the condition of the ground and the surroundings will affect the stated maximum values. The maximum values do not apply, for example, to off-road situations and will also be lower on hard, firm surfaces if ideal conditions do not exist. As the driver, you are always responsible for deciding whether your vehicle is able to handle a particular situation ⇒ ⚠.

Term	Explanation	Technical data
Ground clearance	This is the vertical distance between the level ground and the lowest part on the vehicle.	Front: maximum 8.6 inches (214 mm). Rear: maximum 10.4 inches (261 mm).
Fording depth in standing water	Distance between the point on the ground that touches the tire and the engine air intake duct.	Maximum 20 inches (500 mm).
Gradient angle	The number of feet (meters) in altitude gained when traveling 100 ft (30.48 m) is given as a percentage or in degrees ⇒ <a href="#">fig. 310 A</a> . Information on the maximum slope the vehicle can climb unassisted (depends on road surface and engine power).	Maximum permissible 31 degrees (corresponds to 60 %).
Lateral angle (vehicle slope)	The maximum angle the vehicle may be driven across terrain without the vehicle rolling over (depends on height of center of gravity) ⇒ <a href="#">fig. 310 B</a> .	Maximum permissible 35 degrees.
Breakover angle	Maximum permitted angle given in degrees that a vehicle driven at low speed can clear a ramp without the underbody of the vehicle scraping the ramp	Maximum 20 degrees.

Term	Explanation	Technical data
Approach/departure angle	Transition from horizontal plane to a slope, or from a slope to flat ground. Maximum angle in degrees the vehicle can be driven at low speed along an embankment without the bumper or underbody scraping.	Front: maximum 25 degrees. Rear: maximum 26 degrees.
Fall line	This is the vertical drop route.	
Articulation	Articulation capability of the vehicle while driving on one side over an object.	

### **WARNING**

Never exceed the recommended maximum values in the above table. Exceeding these values will result in serious personal injury and/or damage to your vehicle.

- All values listed above are for ideal conditions and assume firm, even surfaces that are dry and not slippery.
- Off-road conditions will always be less than ideal. Always reduce the maximum values listed in the table above to allow an adequate margin of safety between the ideal maximum value and your vehicle's actual off-road situation.

## Useful off-road driving equipment

 Please first read and note the introductory information and heed the **WARNINGS** .

The checklist lists only a few of the items that could be very helpful when driving off-road ⇒ . If you have user's manuals or assembly instructions for the listed extra equipment, take them with you off-road and heed them.

### Checklist

Checklist: Useful off-road driving equipment ⇒ .

- ✓ Water, compass, maps, flashlight and spare batteries.
- ✓ Cable winch, tow rod or tow rope strong enough for your vehicle.
- ✓ Mobile phone, shovel, blankets, and rubber boots, tape measure, and yardstick.
- ✓ Vehicles without tire mobility set: Electric air compressor to connect to the 12 Volt socket in the vehicle for inflating the tires.
- ✓ A wooden plank about 2 inches thick and 3 feet long or similar aluminum frame as traction aid for a stuck vehicle or as a base for the vehicle jack.

- ✓ Snow chains for all 4 tires, additional spare tires, and tire mobility set.



## WARNING

Accidents and severe personal injury can result from the improper use of tools or equipment as well as from the use of tools or equipment that are damaged or not right for the job to be done.

## Safety and off-road driving

 Please first read and note the introductory information and heed the **WARNINGS** 

Proper seating position and safety belt use is always important, regardless of whether you are on the highway or driving off-road.

- Every person in the vehicle must sit properly and wear his or her safety belt whenever the vehicle is moving ⇒ *Adjusting the seating position*.
- Every occupant must properly fasten the safety belt belonging to the seat he or she occupies and keep the belt properly fastened while riding in the vehicle. This applies to the driver and all passengers, even when driving off-road ⇒ *Safety belts*.

Safety belts save lives – on the road and off.

### Distance to the steering wheel

When driving off-road, you may want to sit a little differently than you would for normal highway driving.

Depending on the terrain, you may need more strength to control the steering wheel because of the higher forces that can come up from the front wheels.

Sit so that you can clearly see the terrain in front of you, especially when you are driving up or down slopes. Never sit so that the distance from the center of your breast bone to the center of the airbag cover on the steering wheel is less than 10 inches (25 cm)

### Suitable shoes

Never wear shoes with a slippery sole or high-heels when driving off-road, and never drive off-road barefoot. Always wear shoes that support your feet properly and give you a good feel for the pedals.



## WARNING

Not wearing safety belts, or wearing them improperly will increase the risk of serious injuries when driving off-road. Holding the steering wheel improperly will reduce your ability to control the vehicle and can also increase the risk of injury when driving off-road.

- Properly worn safety belts are the single most effective means of reducing the risk of serious injury and death during sudden braking or driving maneuvers and in automobile accidents. For this reason, always wear your safety belt properly and make sure all passengers wear their safety belts properly as well whenever the vehicle is moving.
- Never wrap your thumbs around the steering wheel rim. When driving off-road, obstacles in front of the wheels can make the steering wheel jerk suddenly in your hands and cause personal injury. Rest your thumbs pointing up on the surface of the steering wheel at the 3 and 9 o'clock positions.

# Off-road driving situations

## Introduction

---

In this section you'll find information about:

- Selecting the right gear
- Off-road mode
- Driving in rough terrain
- Driving through water
- Driving over snow-covered terrain
- Driving in steep terrain
- Driving crosswise on a slope
- Avoiding deep ruts and depressions
- Crossing ditches
- Driving in sand and mud
- If the vehicle is stuck
- After driving off-road

Driving off-road: Drive at a crawl; don't speed! Even harmless-looking areas can be dangerous ⇒ .

Volkswagen recommends that you get out of the vehicle and explore the terrain personally before trying to cross it. Walk the area and make sure that the ground is firm enough. Check for obstacles or other hidden dangers. Always obey local requirements and regulations; follow commonly accepted safety practices and use common sense

The examples discussed in this chapter are intended to help you drive safely off-road. But the situation facing you may not fit any of these examples.

The wide range of terrain you can come up against, as well the risks and dangers it may hide, make it impossible to deal with every conceivable situation in this Manual. The examples in this chapter are only general guidelines to help you drive safely off-road. The guidelines may not apply in every situation you encounter. Therefore, it is vital that you know what lies ahead and evaluate possible dangers before you try to drive over difficult or unfamiliar terrain. This will help you to evaluate and prepare for possible dangers.

If necessary, use traction assistance systems while driving off-road but do not use any other driver assistance systems. All other driver assistance systems were designed only for driving on paved roads and must not be used for off-road driving.

### More information:

- Starting assistance systems
- Some basics

### WARNING

Areas that look harmless can, in fact, be very dangerous. Potholes, ditches, trenches, drop-offs, different kinds of obstacles, and soft or swampy ground often cannot be seen and can be partially or fully covered by water, grass, branches, or other things. Driving over such terrain can cause accidents and severe injuries.

- Before crossing an unknown area, carefully explore the route you plan to take on foot.
- Never choose a risky route or run a risk that will endanger you and your passengers. If you have any doubts as to whether the route is safe, turn around use a different route.
- Always adapt driving speed and style to load, terrain, visibility, and weather conditions.

## Selecting the right gear

---

⚠ Please first read and note the introductory information and heed the WARNINGS ⚠

Different kinds of terrain require different gears. Selecting the right one helps you to get through safely.

Before driving over a difficult section, think carefully about which gear you should select. With time, you will learn which gear is best for various types of terrain.

### Basics

- If you select the right gear you will usually not have to slow the vehicle down with the foot brake when driving down slopes - the engine will brake the vehicle. You will then only have to use the brake when the braking power of the engine is not enough.
- Never accelerate more than necessary when driving off-road. If you accelerate too hard, the wheels could lose traction and you could lose control of the vehicle.

### Automatic transmission

- Use selector lever position **(D)** when driving on ordinary level areas.
- Use Tiptronic mode and put the vehicle in **2nd** or **3rd** gear when driving through moderately difficult off-road terrain, for example mud, sand, water, or hills ⇒ *Shifting*.
- Use Tiptronic mode and shift into **1st** gear when driving up or down steep hills ⇒ *Shifting*. Use Hill Hold ⇒ *Starting assistance systems*.
- On soft or slippery surfaces, drive at an appropriate speed and in the highest possible driving range of the Tiptronic.

## Off-road mode

---



Fig. 311 In the lower front center console: Rotary knob (4MOTION).

⚠ Please first read and note the introductory information and heed the WARNINGS ⚠

*Off-road mode* is a special driving program that adjusts the vehicle's performance for off-road driving situations ⇒ ⚠. This setting affects the following systems and features:

- ESC, ASR, EDL, and ABS.
- Hill Descent Assist.

The speeds at which the automatic transmission shifts gears are affected.

### Switching off ASR and ESC on some models

On all models, you can switch off Anti-Slip Regulation (ASR) by pushing the  button in the lower front center console (see *Braking and parking*).



On some models, you can also use this button to switch off the entire Electronic Stability Control (ESC) when the vehicle is in *Off-road mode*.

Press and hold button	Status
Up to 3 seconds	ASR switched off.
3 to 10 seconds	ESC switched off.

If you switch from *Off-road mode* back to *On-road mode*, ESC is automatically switched back on again if it was off. However, ASR remains disabled.

### **WARNING**

Never drive on paved roads in *Off-road mode*. This can cause dangerous driving situations, accidents, and severe personal injuries.

- This mode is designed solely for off-road driving. If used on paved roads, the ESC, ASR, EDL, and ABS systems can affect vehicle handling and make it unstable.
- Always make sure to switch off *Off-road mode* as soon as you are back on a paved road.

## Driving in rough terrain

 Please first read and note the introductory information and heed the **WARNINGS** 

### Driving tips

- Drive no faster than a crawl over rocky sections.
- Drive around obstacles such as rocks wherever possible. If this is not possible:
- Carefully advance until one front wheel is *on* the rock and then slowly drive over it ⇒ .

### **NOTICE**

- If you are facing a large rock or tree stump or other large obstacle, do not attempt to drive straight over it or to climb over it with just 2 wheels. A rock or other obstacle that is too high for your vehicle to clear will damage and may disable the vehicle if you try to drive over it. You could be stranded far away from help. Never let large obstacles pass under the vehicle. If there is no way around them and they are too large to drive over, back up and find another route.
- Even obstacles that are lower than your vehicle's ground clearance can come into contact with the underbody and damage or disable your vehicle. Such obstacles are especially dangerous when the ground around them is soft or there is a dip right in front of or behind them. They are also dangerous if you drive over them too quickly and the shock absorbers are compressed.



Leaking engine oil and brake fluid can pollute the environment. Collect leaking operating fluids and dispose of them properly in accordance with applicable environmental laws and regulations.

## Driving through water

---

☐ Please first read and note the introductory information and heed the WARNINGS ⚠

### Important factors when deciding whether to drive through water:

- Water depth.
- Strength of the current.
- Firmness of stream bed and bank.
- Shape of the bank.
- Objects in the water.
- Maximum fording depth of the vehicle

### Before driving through water

Stop, get out of the vehicle, and assess the situation ⇒ ⚠:

- Measure water depth from one side to the other. Check the firmness of the bed and banks; check for drop-offs and obstacles in the water ⇒ ⚠.
- Make sure it is possible to enter and exit the water safely.
- Check the angle of the embankment and the firmness of the ground on each bank.
- Switch to off-road mode.

### Driving through standing and slow-moving water

The vehicle can drive through standing water if the ground under the water is firm enough ⇒ ⚠.  
Never exceed maximum fording depth

- Drive slowly into a river in the direction of the flow. Never exceed the departure/approach angle and lateral angle (vehicle slope).
- Always drive at a constant speed to the other side.

This will help prevent engine damage from the water. It also allows an air pocket to form in front of the engine that can supply it with the necessary air.

Entering the water quickly or driving too fast through the water will create a bow wave. A bow wave can force its way into the engine air intake duct and seriously damage the engine.

### Driving through fast-moving water

Driving through fast-moving water is very dangerous ⇒ ⚠.

The vehicle can be swept away by the current. Even vehicles with high ground clearance can get stuck if the ground is washed out from under the tires. Fast-moving water will build up against the side of your vehicle. This will make the water deeper. Always think about this before entering the water. Water volume, speed, and depth can be very unpredictable and dangerous.

If you are uncertain how fast the water is flowing, look for a shallower place where you can cross in safety. If you cannot find a safe place to cross, turn back.

### Headlight washer system instructions

Do not use the headlight washer system when driving through water. Things in the water can enter into the openings when the washer nozzles are extended. This can prevent the washer nozzles from retracting to their normal position. If this should happen, carefully remove the objects.

### After driving through water

- After crossing through deep water, stop the engine and check the oil dipstick. If there are beads of water on the oil dipstick or the oil level has increased, do not start the engine. Change the engine oil immediately. Depending on the amount of water in the oil, running or starting the engine can result in engine failure or serious engine damage.

- Always dry the brakes by braking a couple of times.
- After driving through water, have the vehicle drive train and electrical system thoroughly inspected for damage by an authorized Volkswagen dealer or an authorized Volkswagen Service Facility.

### WARNING

Flowing water is very powerful and can sweep your vehicle away. This can lead create an extremely dangerous situation and cause an accident with serious personal injuries.

- Never take routes or risks that could put you or your passengers in danger. If you cannot go on or have doubts about the safety of your route, turn back and take a new route.
- Never stop in the water.
- If water gets into the engine, your vehicle can break down. You will lose control of a broken down vehicle, and it can be swept away.
- Soft surfaces, mud, underwater obstacles, and holes can cause accidents and can cause the vehicle to break down in the water. This can lead pose extreme danger.
- Rapidly flowing water can develop strong forces that can pull the vehicle downstream. This can cause accidents and fatal injuries.
- Drive through water only where the banks and bottom are firm enough and the water is shallower at all points than the maximum permissible fording depth for your vehicle → table on page 556.

### NOTICE

- Vehicle components such as the engine, drive train, suspension or electrical system may be severely damaged by driving through water.
- Avoid stopping in deep water. This can let water get inside the vehicle.
- On soft ground, the tires dig into the surface. This reduces fording depth. Make sure that the ground is sufficiently firm.
- Avoid creating a bow wave in front of the vehicle while driving through water. A bow wave could force its way into the engine air intake duct and seriously damage the engine.
- If you even briefly exceed the maximum fording depth when driving through water, severe engine damage will result. This engine damage will lead to a vehicle breakdown. This can disable the vehicle in the water.
- Never drive over salt flats or through salt or salty water. Salt causes vehicle corrosion. Rinse all parts of the vehicle that were exposed to salt or salt water right away with fresh water.

## Driving over snow-covered terrain

 Please first read and note the introductory information and heed the WARNINGS 

Install snow chains on all 4 tires before driving over snow-covered terrain.

Snow-covered terrain may look harmless but the snow can hide many dangers. This is particularly true for stretches where you can't see the tracks left by other vehicles.



## WARNING

Driving through snow-covered terrain is very dangerous.

- Never take routes or risks that could put you or your passengers in danger. If you cannot go on or have doubts about the safety of your route, turn back and take a new route.
- Potholes, ruts, ditches, drop-offs, and other obstacles are often partially or completely hidden by the snow, especially when it is deep.
- Snow-covered dangers can lead to an accident, serious personal injury, or stranding under extreme weather conditions.
- Always adapt driving speed and style to load, terrain, visibility, and weather conditions.

## Driving in steep terrain

---

📖 Please first read and note the introductory information and heed the WARNINGS ⚠️

### Driving on slopes

**Before** driving up or down a slope, get out of the vehicle, explore the terrain, and assess the situation.

- Walk the grade you intend to drive, check the stretch for firmness and obstacles or other hidden dangers ⇒ ⚠️.
- Find out how the route continues at the end of a steep angle.
- If the route is too steep or too uneven or the ground is too loose, do not drive this route. Find an alternative.
- Drive at a constant speed straight up or down a slope.
- Use just as much power as needed to get up the slope. Too much power makes the tires slip, spin, or lose traction. This can increase your risk of losing control. However, too little power will increase the likelihood of stalling.
- Never stop or try to turn around on a slope.
- Do not let the engine stall.
- Do not change gears while climbing the slope.

### If you get stuck while driving up a slope

- Never try to turn around.
- If your engine stalls, apply the foot brake and restart the engine.
- Shift into reverse and back your vehicle carefully straight down the slope.
- Use the brake to keep the speed steady when backing down to a safe place.

### Driving down a slope

Never exceed the vehicle's maximum lateral angle (vehicle slope). If an emergency forces you to cross the slope and the vehicle threatens to roll over, immediately steer the vehicle downhill along the fall line.

There is an increased risk of rollover when driving down a slope. For this reason, concentrate on steering safely down the slope.

Use Hill Descent Assist on steep descents.

- Drive down steep slopes in first gear.
- Gently apply the foot brake to help keep the vehicle under control.
- If it is possible and if it is not dangerous, drive straight down the fall line (maximum slope).
- Do not shift into Neutral (N).

## **⚠ WARNING**

Never try to drive up or down slopes that are too steep for your vehicle. The vehicle could slide away, tip over, or roll over.

- Never take routes or risks that could put you or your passengers in danger. If you cannot go on or have doubts about the safety of your route, turn back and take a new route.
- The lateral angle must never be more than the maximum angle approved for the vehicle.
- Always drive along the fall line when driving up or down a slope.
- Never try to turn the vehicle around on a slope. The vehicle could tip over or roll down the slope.
- If the engine stalls or you can no longer drive up the slope for any reason, stop and apply the foot brake. If stalled, apply the foot brake and restart the engine. Then shift into Reverse (R) and carefully back your vehicle straight down the slope along the fall line. Keep the vehicle speed slow and even.
- If the engine will not restart, apply constant pressure to the foot brake and carefully back straight down the slope the same way you drove up. Keep the vehicle speed slow and even.
- If the engine is running, select Reverse and carefully back straight down the slope the same way you drove up. Use engine braking power and the foot brake to keep the vehicle speed slow and even.
- Never just roll down a slope with the transmission in Neutral (N). You could lose control of the vehicle.

## Driving crosswise on a slope

---



Fig. 312 Steer downhill along the fall line.

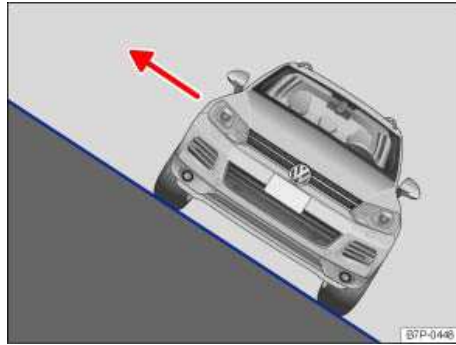

**Fig. 313** On a slope, always exit on the uphill side of the vehicle.

**⚠ Please first read and note the introductory information and heed the WARNINGS ⚠**

Driving crosswise on a slope is one of the most dangerous off-road driving situations ⇒ ⚠.

Even if it seems harmless, never underestimate the difficulties and hazards when driving crosswise on a slope. A vehicle perpendicular to the slope of the hill can become uncontrollable and slide away, tip, or roll over. This could cause severe or fatal injuries to all occupants.

#### **Driving at an angle to the slope**

**Before** driving crosswise on a slope, check whether there is a different, safer route.

If you have to drive across a slope, first make sure the ground is firm and even along your route. If the ground is soft or slippery, the vehicle is more likely to slip away to the side. Make sure that the angle does not become too great due to surface unevenness. This can make the vehicle tip and roll over.

The steeper the slope across which the vehicle is moving, the more important it becomes to make sure the wheels on the lower side do not run over holes or depressions. The wheels on the high side must never run over protruding rocks, tree stumps, or other obstacles.

If the vehicle threatens to tip, immediately steer downhill into the “fall line” and gently accelerate ⇒ [fig. 312](#). If it is not possible to steer down the fall line, steer uphill and gently accelerate.

The vehicle center of gravity should be as low as possible. The weight of all passengers should be evenly distributed. Taller or heavier passengers should sit on the higher side of the vehicle. Luggage on the roof should be removed and heavy objects should be secured, as the vehicle could tilt due to the sudden shifting of objects in the vehicle ⇒ ⚠.

While driving across the slope, passengers on the rear bench should always sit on the uphill side of the vehicle. In extreme cases, passengers on the downhill side must get out of the vehicle until the hill has been safely crossed.

#### **Exiting on a hillside**

If the vehicle comes to a standstill at a significantly tilted angle on the hillside, all passengers should exit the vehicle on the uphill side ⇒ [fig. 313](#). This applies even if the uphill door is hard to open. The uphill-side door may swing shut due to its weight or carelessness.

## WARNING

Never try to drive crosswise on a slope, especially one that is too steep for your vehicle. The vehicle could slide sideways and tumble down the slope. To reduce the risk of accidents and serious injuries:

- Never underestimate the difficulties and dangers of driving crosswise on a slope. Never take routes or risks that could put you or your passengers in danger. If you cannot go on or have doubts about the safety of your route, turn back and take a different route.
- When driving crosswise on a hill, the vehicle can lose its hold, slide sideways, tip or turn over and roll down the hill.
- Make certain that the wheels on the downhill side of the vehicle do not run over holes or depressions. Make certain that the wheels on the high side of the vehicle do not run over rocks, tree stumps, or protruding objects.
- Before driving crosswise on a hill, check whether it is possible to steer into the fall line along the selected route. If this is not possible, select a different route. If the vehicle threatens to tip, immediately steer downhill into the fall line and gently accelerate ⇒ [fig. 312](#).
- If the vehicle is stopped a hillside and is laterally tilted, avoid sudden and uncontrolled movement in the vehicle. The vehicle can lose its hold, slide sideways, tip, or turn over and roll down the hill.
- If the vehicle is stopped at while pointed crosswise on a steep slope, make certain that no one exits the vehicle through a door on the downhill side. This can shift the vehicle center of gravity to the downhill side. The can tilt or roll over and roll down the hill. To help minimize this risk, always exit the vehicle through the doors that are facing uphill ⇒ [fig. 313](#).
- When getting out, make certain that doors opened on the uphill side are not closed carelessly and do not swing shut due to their own weight and injure anybody.

## Avoiding deep ruts and depressions

 Please first read and note the introductory information and heed the WARNINGS 

Ruts are very common on forest trails, in grassland and fields, as well as on much-used cross-country lanes.

If the ruts and depressions are firm and shallow, simply follow the ruts.

Do not drive in ruts and depressions that are too deep ⇒ . If deep ruts and depressions cannot be avoided, turn around.

## NOTICE

If ruts and depressions become too deep, the vehicle underbody can bottom out and get stuck. This can damage or even disable the vehicle.

## Crossing ditches

 Please first read and note the introductory information and heed the WARNINGS 

- Check whether the approach/departure angle and the lateral angle (tilt) are small enough to allow the vehicle to cross the ditch.
- If possible, cross the ditch at an acute angle ⇒ .
- This is only possible if the lateral angle (side-to-side tilt) is not too large.



## WARNING

If the approach/departure angle or the lateral angle of the ditch are too steep for the vehicle, do not attempt to cross the ditch. The vehicle can fall over on its side, slide sideways, or turn over.



## NOTICE



If you enter at right angles to the ditch, the front wheels will fall into the ditch. The underbody of the vehicle can get stuck and the vehicle can be damaged or disabled. Getting out of a ditch without assistance is rarely possible, even with all-wheel drive.

## Driving in sand and mud

---

 Please first read and note the introductory information and heed the WARNINGS 

Always drive at a constant speed through sand and mud; do not shift gears manually and do not stop.

- Check whether ESC is active. The indicator light  or  in the instrument cluster must both be off ⇒ *Braking and parking*.
- Select a suitable gear and remain in this gear until solid ground is reached ⇒ *Selecting the right gear*.
- Always keep the vehicle moving.

Never drive too fast through sand and mud. The wheels may spin and the vehicle can get stuck. If the tires no longer grip, turn the steering wheel back and forth slightly in short, quick movements. This can improve front wheel traction when driving in sand and mud.

### Driving through sand

Never reduce tire inflation pressure before driving through sand ⇒ . If you have reduced the tire pressure to drive through sand, make sure to correct the tire pressure afterwards before driving any farther. Driving with reduced tire pressure can make you lose control of the vehicle and increase the risk of serious or fatal injuries.

### Driving through mud

Do not change your speed or your direction. The tires can lose their grip in mud. If the vehicle skids, steer in the direction the vehicle is sliding to try to get it back under control.



## WARNING

Driving through sand and mud can be dangerous. The vehicle can skid out of control and crash, causing serious injuries. Always drive carefully when driving in sand and mud.

- Never take routes or risks that could put you or your passengers in danger. If you cannot go on or have doubts about the safety of your route, turn back and take a different route.



## WARNING

Driving on tires that are not inflated to the correct cold tire inflation pressure can cause an accident with serious or fatal injuries.

- If the tires are not inflated to the correct pressure, they will wear out faster and the vehicle will not handle as well.
- Incorrect tire pressure can make tires overheat, resulting in tire damage including tire tread separation and sudden blowouts that can make you lose control of the vehicle.

## If the vehicle is stuck

 Please first read and note the introductory information and heed the WARNINGS 

It takes experience and a fine touch to “rock” a vehicle back and forth to get it going when it is stuck. If you go about it the wrong way, you'll dig the vehicle in even deeper and need someone to tow you free.

### If the vehicle won't budge

- Carefully dig out all 4 wheels and make sure that no other parts of the vehicle are stuck in the sand.
- Select reverse gear.
- Carefully accelerate and try to back up in your own track.

If this doesn't help, try placing brushwood, floor mats, or burlap sackcloth directly in front of the tires to improve grip and traction ⇒ .

### Rocking the vehicle free

Don't spin the wheels. It's unlikely to help you get going and all but certain to dig you in even deeper if you do it too much ⇒ .

- Switch off Anti-Slip Regulation (ASR) ⇒ *Braking and parking*.
- Switch to *off-road mode*.
- Turn the steering wheel so that it points straight ahead.
- Shift into reverse and accelerate just to the point where the wheels first start to spin.
- Immediately engage first gear and accelerate again until the wheels just begin to spin.
- Repeat this process to get the vehicle to rock back and forth and then hopefully develop enough forward momentum to get going again.
- Once the vehicle is free, switch ASR back on ⇒ *Braking and parking*.

## WARNING

Make sure there are no people or animals in front of or behind the vehicle, especially when it is stuck and you are trying to rock it loose.

- Stones, brush, pieces of wood, and other objects under the wheels can be thrown at great velocity when they spin. This can cause serious or even fatal injuries.
- If the stuck vehicle suddenly regains traction, it will lurch forward and can run over anybody who is standing too close to it in the front or in the back.

## After driving off-road

☐ Please first read and note the introductory information and heed the WARNINGS ⚠

After an off-road drive, you always need to check the vehicle's underbody for damage and may need to clean the radiator grille ⇒ ⚠.

### Checklist

Checklist: Perform after every off-road drive ⇒ ⚠:

- ✓ Turn the rotary knob in the front center console back to *On-road mode* and switch ASR/ESC back on ⇒ *Braking and parking*.
- ✓ Clean the turn signal lights, the headlights and taillights, the license plate, and all windows.
- ✓ If required, remove the towing eye(s) and snow chains.
- ✓ Check tires, suspension struts, and axles for damage and remove coarse dirt, stones, and foreign objects from the tire tread.
- ✓ Examine the vehicle underbody and remove objects such as twigs, leaves, or bits of wood that have gotten stuck in the brake system, the wheels, the suspension, the exhaust system, of the engine ⇒ ⚠. If damage or leaks are detected, see an authorized Volkswagen dealer or an authorized Volkswagen Service Facility.
- ✓ Remove coarse dirt from the radiator grille and the vehicle underbody ⇒ *Exterior care and cleaning*.
- ✓ Check the engine compartment to for dirt that interferes with engine operation ⚠ ⇒ *Working in the engine compartment*.
- ✓ After driving in sandy or dusty areas, have the air cleaner checked, and if necessary cleaned by an authorized Volkswagen dealer or authorized Volkswagen Service Facility so that dust, sand, and grit does not get drawn into the engine.

### ⚠ WARNING

Objects trapped under the vehicle floor can damage the brake system, fuel lines, gaskets, and other underbody parts. Such objects can also ignite on contact with hot vehicle components. You must check after each off-road outing to see whether any foreign objects have gotten stuck in the vehicle underbody.

- Never drive the vehicle if any foreign objects are stuck in the brake system, the wheels, the suspension, the exhaust system, or the engine or engine compartment.
- Flammable materials such as dry leaves or twigs can catch fire from contact with hot vehicle components. A fire can cause serious personal injuries.
- Trapped objects can damage or block the fuel lines, the brake system, gaskets, and other parts of the suspension system. This can cause you to lose control of the vehicle and have an accident.

### ⓘ NOTICE

Dust, sand, grit, and other material that has collected in the air filter after driving in certain kinds of off-road terrain can be drawn into the engine and cause expensive damage. After driving off-road where it is very dusty or sandy, be sure to have the air filter checked and, if necessary, cleaned by an authorized Volkswagen dealer or authorized Volkswagen Service Facility.

# Working in the engine compartment

## Introduction

---

In this section you'll find information about:

Warning light

Preparing to work in the engine compartment

Opening and closing the engine compartment

Always position the vehicle on a firm and level surface before doing any work in the engine compartment.

The engine compartment of a vehicle is a hazardous area. Never do any work on the engine or in the engine compartment unless you

- know exactly how to carry out the job,
- have the correct technical information and the proper tools and supplies, and
- are familiar with the necessary safety precautions ⇒  !

If you are uncertain in any way, have the work done by an authorized Volkswagen dealer or an authorized Volkswagen Service Facility. Serious personal injury may result from improperly performed work.

### **More information:**

- Exterior views
- Windshield wiper and washer
- Starting and stopping the engine
- Brake fluid
- Hybrid drive vehicles
- Checks while refueling
- Engine oil
- Engine coolant
- 12 Volt vehicle battery
- Exterior care and cleaning
- Parts, accessories, repairs and modifications



## DANGER

The vehicle's high-voltage electrical system and high-voltage battery are dangerous and can cause burns, other serious personal injuries, electrocution, and death.

- Always assume that high-voltage battery and parts of the high-voltage system are fully charged and energized.
- Never touch or let jewelry or other metal objects contact high-voltage cables or the high-voltage battery and battery poles, especially if the cables, battery, and battery poles have been damaged in any way.
- Never do any work yourself on the high-voltage electrical system, the orange-colored high-voltage wiring, or on the high-voltage battery.
- Never open, service, repair, or disconnect any part of the hybrid electrical system.
- Never damage the orange-colored high-voltage cables. Never remove them and never disconnect them from the high-voltage electrical system.
- Never open or remove the orange-colored cover on the high-voltage battery.
- Always have work on the hybrid electrical system and systems that could be indirectly affected by it done by qualified, trained technicians who have the know-how, experience, documentation, and tools to do the work safely.
- All work on the high-voltage electrical system and the high-voltage battery must be done in compliance with Volkswagen standards and guidelines.
- Vehicle keys must be safely stored a safe distance from vehicle so that the ignition cannot be switched on and energize the electrical system.
- Gases vented or released from the high-voltage battery vapors are potentially poisonous and can burn.
- Physical damage to the vehicle or the high-voltage battery can result in immediate or delayed release of poisonous gases that can also cause a fire.
- Always avoid contact with leaking fluids and gases escaping from the battery, particularly one that has been damaged.
- Always tell emergency responders that the vehicle has a high-voltage battery.



## WARNING

Unintended vehicle movement during maintenance work can cause serious personal injuries.

- Never work under the vehicle unless you have safely secured the vehicle from moving. If you must work under the vehicle with the wheels on the ground, always make sure that the vehicle is on level ground, that all 4 wheels are chocked to keep them from moving, and that the key is not in the ignition.
- If you must work under a vehicle raised on a floor jack, always make sure that the vehicle is safely supported on safety stands intended for that purpose that are strong enough to support the weight of the vehicle. The jack supplied with the vehicle is not strong enough for this purpose and can collapse causing serious personal injury.

 **WARNING**

The engine compartment of any motor vehicle is a potentially dangerous area and can cause serious personal injury.

- Always use extreme caution when doing any work in the engine compartment. Always follow commonly accepted safety practices and use common sense. Never risk personal injury.
- Never perform any work in the engine compartment unless you know exactly how to carry out the job and have the correct technical information and the correct tools.
- If you are uncertain about what to do, have the work performed by an authorized Volkswagen dealer, an authorized Volkswagen Service Facility, or another qualified workshop. Serious personal injury may result from improperly performed work.
- We strongly recommend that you always have HID – High Intensity Discharge (Xenon) headlights and H7 bulbs replaced by a qualified technician. Serious personal injury may result from improperly performed work.
- Never open or close the engine hood if steam or coolant is escaping. Hot steam or coolant can cause serious burns. Always wait until you no longer see or hear steam or coolant escaping from the engine.
- Always let the engine cool down completely before carefully opening the hood.
- Hot parts of the engine and the exhaust system will burn skin on contact.
- When the engine has cooled down and you are ready to open the hood:
  - Apply the electronic parking brake and shift the transmission into Park (P).
  - Take the vehicle key out of the ignition.
  - On vehicles with Keyless Access, make sure that the remote control vehicle key is out of range of the vehicle and that the vehicle cannot be started by depressing the starter button.
  - Always keep children and others away from the engine compartment and never leave them unsupervised.
- The engine coolant system is under pressure when the engine is hot. Never unscrew the coolant expansion tank cap when the engine is hot. Hot coolant can spray out and cause severe burns and other serious injuries.
  - Turn the cap slowly and very carefully in a counterclockwise direction while applying light downward pressure on the top of the cap.
  - Always protect your face, hands, and arms from hot escaping coolant or steam by covering the cap with a large, thick rag.
- Never spill fluids on the engine or exhaust system when refilling. Spilling fluids onto hot parts of the engine or exhaust system can cause a fire.



### WARNING

High voltage systems in the engine compartment can cause electrical shocks or even electrocution, severe burns, other serious injuries, and even death!

- Never short-circuit the electrical system. Be especially careful when using jumper cables. The vehicle's battery could explode!
- To reduce the risk of electrical shock and personal injury while the engine is running or being started:
  - Never touch ignition cables. Never touch other components of the high-voltage electronic ignition system.
  - Never touch the wiring of the HID – High Intensity Discharge (Xenon) headlights.
- Read and heed the important information and warnings on cleaning the engine compartment ⇒ *Cleaning the engine compartment.*



### WARNING

Moving parts in the engine compartment can cause serious personal injury on contact.

- Never reach into the area around or touch the radiator fan. Contact with the blades can cause serious personal injury. Always remember that the radiator fan is temperature-controlled and can come on suddenly even when the engine has been switched off for a while and the key has been removed from the ignition.
- If you have to perform a check or repair when the engine is running, there are more risks from the rotating parts, such as the drive belts, alternator, radiator fan, etc., and from the high-voltage ignition system. Always use extreme care.
  - Always make sure that jewelry, loose clothing and long hair do not get caught in rotating engine parts. Before starting any work remove your jewelry, take off your necktie, tie back and cover your hair, and do not wear clothing that can hang down and get caught in moving engine parts.
  - Always use extreme caution if the accelerator pedal has to be depressed to perform a check. The vehicle will start to move even if the parking brake is on.
- Never leave any objects in the engine compartment, for example cleaning rags and tools. Objects left behind can cause malfunctions, engine damage, and even fires.



### WARNING

Operating fluids and some materials in the engine compartment can catch fire easily, causing burns and other serious personal injuries!

- Do not smoke.
- Never work next to open flames or sparks.
- Never pour or spill operating fluids or other flammable liquids on the engine. These fluids can ignite on hot engine parts and cause injuries.
- If work on the fuel system or the electrical system is necessary:
  - Always disconnect the 12 Volt vehicle battery. Make sure the vehicle is unlocked when you disconnect the battery, or the alarm will go off. Never touch the electrical wiring of the ignition system.
  - Never work near heaters, water heaters, or other open flames.
- Always have a functional, approved fire extinguisher nearby.

## NOTICE



When changing or topping off fluids, make sure that you pour the fluids into the correct reservoirs. Adding the wrong type of operating fluids will cause serious malfunctions and engine damage!



Fluid leaks are harmful to the environment. Regularly check the ground underneath your vehicle for this reason. If you find spots of oil or other fluids, have your vehicle checked by your authorized Volkswagen dealer or authorized Volkswagen Service Facility. Dispose of leaked operating fluids properly.

## Warning light

 Please first read and note the introductory information and heed the WARNINGS 

Lights up	Possible cause	Proper response
	Engine hood not properly closed.	 <b>Stop!</b> Close the engine hood.

When the ignition is switched on, several warning and indicator lights come on briefly for a function check. They go out after a few seconds.

If the engine hood is open or not closed properly, the warning light  comes on in the instrument cluster.

Depending on your vehicle's equipment and options, a symbol showing that the hood is not properly closed may appear in the instrument cluster display instead of the warning light. The symbol will still be displayed even after the ignition is switched off. The display goes out about 15 seconds after the vehicle has been locked with the doors closed.

## WARNING

Failure to heed warning lights and instrument cluster text messages can cause the vehicle to break down in traffic and result in a collision and serious personal injury.

- Never ignore warning lights or text WARNINGS.
- Always stop the vehicle as soon as it is safe to do so.

## Preparing to work in the engine compartment

 Please first read and note the introductory information and heed the WARNINGS 

### Checklist

Before any work in the engine compartment, carry out the following steps in the order in which they are listed → .

- ✓ Park the vehicle in a safe place on a firm, level surface.

- ✓ Hold the brake pedal down until the engine is switched off.
- ✓ Apply the electronic parking brake to help prevent the vehicle from moving ⇒ *Braking and parking*.
- ✓ Shift the transmission into Park (**P**) ⇒ *Shifting*.
- ✓ Stop the engine and remove the key from the ignition switch ⇒ *Starting and stopping the engine*.
- ✓ Let the engine cool down sufficiently.
- ✓ Keep children and others away from the vehicle.
- ✓ Make sure the vehicle cannot move unexpectedly.



### WARNING

Disregarding the safety-related checklist may result in serious injuries.

- Always review and follow the checklist. Follow accepted safety practices and use common sense.

## Opening and closing the engine compartment



Fig. 314 Inside hood release lever in the footwell on the driver side.



Fig. 315 Outside hood release in the radiator grille.

⚠ Please first read and note the introductory information and heed the WARNINGS ⚠

### Opening the engine hood

- Before you open the hood, make sure that the windshield wiper arms are resting on the windshield ⇒ ⌚.



- Open the driver door and pull the inside hood release lever in the direction of the arrow ⇒ [fig. 314](#).
- The engine hood is released from its latch by a spring ⇒ .
- Push the outside hood release lever ⇒ [fig. 315](#) (arrow) and lift the hood all the way up. A gas-filled strut will hold the hood up.

#### Closing the engine hood

- Pull the hood down to overcome the resistance of the gas-pressure strut ⇒ .
- Let the engine hood drop into the hood latch – do *not* press it afterwards!

If the hood does not close completely, open it again and close it properly.

When the hood is properly closed, you can see that it fits flush with the other body parts. The indicator light in the instrument cluster will go out

#### WARNING

**If the hood is not closed properly, it could fly up and block your view while you are driving. This can lead to a crash and serious personal injuries.**

- After closing the engine hood, check that the hood release lever is properly latched into the hood latch. The engine hood must be flush with the surrounding auto body parts.
- If you ever notice that the hood latch is not properly secured when the vehicle is moving, stop at once and close it.
- Never let anyone get in the way of the hood when closing it.

#### NOTICE

- Make sure the windshield wipers are switched off and the windshield wiper arms are resting on the windshield before you open the hood. Otherwise, the windshield wipers and the hood may be damaged.
- Always put the windshield wiper arms down against the windshield before driving the vehicle.

#### NOTICE

Before opening or closing the engine hood, make sure there is enough room to do so, for example when the vehicle is in a garage.

# Engine oil

## Introduction

---

In this section you'll find information about:

- Warning and indicator lights
- Engine oil specifications
- Engine oil capacities
- Checking the engine oil level and adding oil
- Engine oil consumption
- Changing engine oil

### More information:

- ⇒ Booklet *Warranty and Maintenance*
- Infotainment System
- Working in the engine compartment
- Parts, accessories, repairs and modifications



### WARNING

**Improper handling of engine oil can cause severe burns and other serious injuries.**

- **Always wear eye protection.**
- **Engine oil is poisonous and must be stored out of the reach of children.**
- **Store engine oil only in the closed original container. This also applies to used oil until disposal.**
- **To reduce the risk of poisoning, never drain the oil into empty food or beverage containers that might mislead someone into drinking from them.**
- **Continuous contact with used engine oil is harmful to your skin. Always protect your skin by washing thoroughly with soap and water.**
- **Engine oil becomes extremely hot when the engine is running and can cause severe burns. Always let the engine cool down to the touch.**







Like all other operating fluids, engine oil can pollute the environment. Collect leaked or spilled operating fluids and dispose of them properly in accordance with applicable environmental laws and regulations.

## Warning and indicator lights

---

 Please first read and note the introductory information and heed the WARNINGS 

Lights up	Possible cause	Proper response
	Engine oil pressure too low.	 <b>Stop!</b> Switch off the engine. Check the engine oil level. – If the warning light flashes although the oil level is normal, <i>do not</i> continue driving or let the engine idle. Otherwise, the engine could be damaged.
	Engine oil level too low.	Stop the engine. Check the engine oil level.
	Engine oil pressure too low.	Without exceeding the maximum engine speed (rpm) shown in the instrument cluster display, drive to a qualified workshop and have the system checked.

Flashes	Possible cause	Proper response
	Engine oil system malfunction.	Have the engine oil sensor checked by an authorized Volkswagen dealer or an authorized Volkswagen Service Facility.

When the ignition is switched on, several warning and indicator lights come on briefly for a function check. They go out after a few seconds.

 **WARNING**

Failure to heed warning lights and instrument cluster text messages can cause the vehicle to break down in traffic and result in a collision and serious personal injury.

- Never ignore warning lights or text WARNINGS.
- Always stop the vehicle as soon as it is safe to do so.



## NOTICE

Failure to heed warning lights or text WARNINGS can result in vehicle damage.

### Engine oil specifications

 Please first read and note the introductory information and heed the WARNINGS 

The engine oil used must conform to exact specifications.

Using the proper engine oil is important for the functionality and service life of the engine. Your engine was factory-filled with a high-quality multi-grade oil which can usually be used throughout the entire year.

Engine oils are constantly being improved. Authorized Volkswagen dealers and authorized Volkswagen Service Facilities are always up-to-date regarding new developments and changes. Volkswagen therefore recommends that you have the engine oil changed by an authorized Volkswagen dealer or an authorized Volkswagen Service Facility.

Engine oil quality is based not only on requirements for engines and exhaust treatment systems, but also on fuel quality. Engine oil comes into contact with fuel and fuel residue in all internal combustion engines, causing engine oil to age and its lubricating qualities to deteriorate.

Your engine was factory-filled with a high-quality, "synthetic" all-season engine oil that meets strict Volkswagen oil quality standards and has a viscosity grade of SAE 5W-40. You can use this oil for normal driving in all temperatures.

If you need to add oil between oil changes, use only a high quality oil that expressly complies with the Volkswagen oil quality standard specified for your vehicle's engine:

Engines	Engine oil specification
Gasoline engines and hybrid vehicles	VW 502 00, VW 503 00, VW 504 00
Diesel engines	VW 504 00, VW 507 00

At the time this Manual was printed, the engine oils available in the U.S. that meet these Volkswagen standards are "synthetic" oils. This does not mean, however, that any "synthetic" engine oil will meet Volkswagen standards. Always use an approved oil that expressly complies with the Volkswagen oil quality standard that applies to your vehicle's engine.

#### General recommendations:

If "synthetic" oil that meets the applicable Volkswagen oil quality standard with viscosity grade SAE 5W-40 or SAE 5W-30 is not available in your area, be sure to use a viscosity grade suitable for the climate, season, and operating conditions that exist where the vehicle is used. Make sure the oil meets the quality standard

Engine oils are constantly being improved. Authorized Volkswagen dealers and authorized Volkswagen Service Facilities are always up-to-date regarding new developments and changes. Volkswagen therefore recommends that you have the engine oil changed by an authorized Volkswagen dealer or an authorized Volkswagen Service Facility.

## NOTICE

- If you need to add oil and there is none available that meets the Volkswagen oil quality standard your engine requires, you may add a total of no more than 1/2 quart (0.5 liter) of a high-quality “synthetic” oil that meets ACEA A3 specifications and has a viscosity grade of SAE 5W40 or SAE 5W30.
- Use only a high quality engine oil that expressly complies with the Volkswagen oil quality standard specified for your vehicle's engine. Using any other oil can cause serious engine damage that will not be covered by any Volkswagen Limited Warranty.
- Do not mix any lubricants or other additives into the engine oil. Doing so can cause engine damage! Damage caused by these kinds of additives are not covered by any Volkswagen Limited Warranty.

## Engine oil capacities

ⓘ Please first read and note the introductory information and heed the WARNINGS ⚠

Disregard

Engines	Engine oil capacity (with filter)
Gasoline engines	About 7.1 quarts (6.7 liters)
Diesel engines	About 8.1 quarts (7.7 liters)
Hybrid engines	About 7.2 quarts (6.8 liters)

## Checking the engine oil level and adding oil

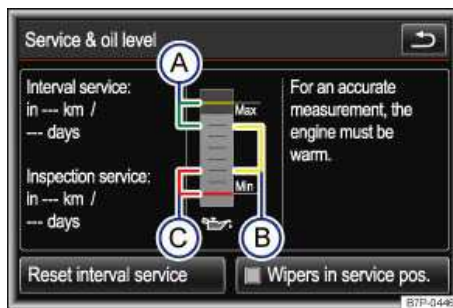

Fig. 316 Infotainment System: Engine oil level display.

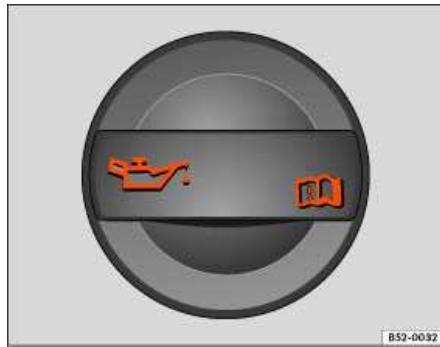

Fig. 317 In the engine compartment: Engine oil filler cap.

⚠ Please first read and note the introductory information and heed the WARNINGS ⚠

### Checklist

Perform the steps in the order listed ⇒ ⚠:

1. With the engine at **operating temperature**, park the vehicle on a level surface to help prevent an incorrect oil level reading.
2. Switch off the engine and wait a few minutes for the engine oil to flow back into the oil pan.
3. The vehicle has **no** engine oil dipstick under the engine compartment. The current engine oil level can be viewed through the Infotainment screen by following these steps ⇒ fig. 316:
  - Switch on the ignition.
  - Press the **CAR** Infotainment button.
  - Tap the **Service** function key on the screen.
  - **OR:** Press the **Settings** and then press the **Service/Control**.
4. Required steps after reading the engine oil level ⇒ fig. 316:
  - (A): **Do not** add any oil ⇒ ⚠. Continue with step 12.
  - (B): Oil may be added (about 1 pint / 0.5 liter). Continue with step 6 to step 12.
  - (C): **You must** add oil (about 1 quart / 1.0 liter). Continue with step 6 to step 12.
5. Open the engine hood ⚠
6. The engine oil filler opening can be identified by the ⚡ symbol on its cap ⇒ fig. 317. If you are not sure where it is, contact your authorized Volkswagen dealer or authorized Volkswagen Service Facility.
7. Remove the cap on the engine oil filler opening ⇒ fig. 317.
8. Only add engine oil that Volkswagen has approved for that engine. Add the oil gradually in small quantities (no more than 1 pint / 0.5 liter).
9. To avoid overfilling, you must wait about 1 minute each time you add oil so that the oil can flow into the oil pan.
10. Recheck the engine oil level through the Infotainment screen, after adding oil, the level must at least be in the center of the ⇒ fig. 316 (B) area, but never above (A) ⇒ ⚠. Never add too much oil.
11. After adding oil, securely install the cap on the engine oil filler opening. Otherwise, oil could leak out while the engine is running.
12. Close the hood ⚠

---

## Engine oil level ranges

⇒ <b>fig. 316</b>	<b>Required action according to the respective engine oil level:</b>
Range (A)	Do <b>not</b> refill oil ⇒ ⓘ.
Range (B)	<b>You may</b> add oil (about 1 pint / 0.5 liters). The oil level may go into the (A) range, but not above the (A) range.
Range (C)	<b>You must</b> add oil (about 1 quart / 1.0 liter). After adding oil, make sure that the oil level is about in the middle of the (B) range.

### **WARNING**

Engine oil can ignite when it touches hot engine parts. This can cause fires, burns, and other severe injuries.

- Never spill oil on the engine. Oil spilled on a cold engine can also cause a fire when the engine warms up.
- Always make certain that you screw the cap of the engine oil filler opening back on tightly after adding oil. This helps prevent engine oil from leaking onto the hot engine when the engine is running.

### **NOTICE**

- Do not start the engine if the engine oil level is above range (A). Contact an authorized Volkswagen dealer or an authorized Volkswagen Service Facility. Otherwise the catalytic converter and engine can be damaged!
- When changing or topping off fluids, make sure that you pour the fluids into the correct reservoirs. Adding the wrong type of operating fluids will cause serious malfunctions and engine damage.



The engine oil level should never be above range (A). Otherwise oil can be drawn in by the crankcase ventilation system and enter the atmosphere via the exhaust system.

---

## Engine oil consumption

 Please first read and note the introductory information and heed the **WARNINGS** 

To provide effective lubrication and cooling for internal engine parts, all internal combustion engines use some oil. Oil consumption varies from engine to engine and may change over the life of the engine. Engines tend to use more oil during the break-in period than they do afterward, when oil consumption has stabilized.

Under normal conditions, the rate of oil consumption depends on oil quality as well as viscosity, engine speed (rpm), outside temperature, road conditions, the amount of oil dilution caused by condensed water or fuel residue, and oxidation of the oil. Oil consumption may increase with engine wear over time, until replacement of worn engine parts may become necessary.

Volkswagen recommends that you to check the engine oil level at regular intervals, preferably every time you fill the fuel tank, and always before a long trip. Your vehicle may consume engine oil depending on several variables. A maximum of 1 quart per 1200 miles (1 liter per 2000 km) would be considered normal. New vehicles may consume more oil over the first 3000 miles (5000 km).

**The oil pressure warning light is not an indicator of low engine oil level. If the warning light stays on or flashes while driving (above 1500 rpm), a chime will sound. It indicates that the oil pressure is too low. Stop the engine immediately, check the engine oil level and add oil if necessary. If the engine oil level is normal, but the light continues to flash, do not keep driving or let the engine idle, as damage may occur.**

If you believe your engine uses too much oil, we recommend that you consult your authorized Volkswagen dealer or authorized Volkswagen Service Facility so that the cause of your concern can be properly diagnosed. Please keep in mind that accurate measurement of oil consumption requires great care and may take some time. Your authorized Volkswagen dealer and authorized Volkswagen Service Facility have instructions for how to measure oil consumption accurately.

 Depending on the way the vehicle is driven and the operating conditions, oil consumption can be up to 1 quart per 1200 miles (0.5 liter per 1000 km). Consumption may be higher for new vehicles during the first 3000 miles (5000 km).

## Changing engine oil

---

 **Please first read and note the introductory information and heed the WARNINGS **

The engine oil must be changed according to the intervals specified in your ⇒ Booklet *Warranty and Maintenance*.

Changing oil at regular intervals is very important because the lubricating properties of oil decrease gradually during normal vehicle use. If you are not sure when to have the oil changed, ask your authorized Volkswagen dealer or authorized Volkswagen Service Facility.

Sometimes, engine oil should be changed more often than specified for normal use. Change oil more frequently if you often drive short distances, in dusty areas or in stop-and-go traffic, or if you use your vehicle where temperatures stay below freezing for long periods.

Volkswagen recommends that you have your oil and oil filter changed by an authorized Volkswagen dealer or an authorized Volkswagen Service Facility ⇒ . They have the required expertise and special tools and will dispose of the old oil properly.

Detergent additives in the oil will make fresh oil look dark after the engine has been running a short time. This is normal and no reason to change engine oil more often.





 **WARNING**

If you must change the engine oil yourself, be sure to take the following precautions:

- Always wear eye protection.
- To reduce the risk of burns from hot engine oil, let the engine cool down completely before beginning.
- When removing the oil drain plug with your fingers, stay as far away as possible. Always keep your forearm parallel to the ground to help prevent hot oil from running down your arm.
- Drain the oil into a container designed for this purpose, one large enough to hold at least the total amount of oil in your engine.
- To reduce the risk of poisoning, never drain the oil into empty food or beverage containers that might mislead someone into drinking from them.
- Engine oil is poisonous and must be stored out of the reach of children.
- Continuous contact with used engine oil is harmful to your skin. Always protect your skin by washing thoroughly with soap and water.

 Before changing the oil, first make sure you know where you can properly dispose of the old oil.

 Dispose of the old oil an environmentally-responsible manner. Never dump the old oil on garden soil, in wooded areas, in the street, into streams, rivers, or bodies of water, or down sewage drains.

 Recycle used oil by taking it to a collection facility for used engine oil in your area, or contact an authorized Volkswagen dealer or an authorized Volkswagen Service Facility.

 Volkswagen recommends that you always have your oil and oil filter changed by an authorized Volkswagen dealer or an authorized Volkswagen Service Facility. They have the required expertise and special tools and will dispose of the old oil properly.

# Engine coolant

## Introduction

---

In this section you'll find information about:

Warning light and engine coolant temperature gauge  
Engine coolant specifications  
Checking engine coolant level and topping off

Never do any work on the coolant system unless you

- know exactly how to carry out the job,
- have the correct technical information and the proper tools, supplies, and operating fluids, and
- are familiar with the necessary safety precautions ⇒  !

If you are uncertain in any way, have the work done by an authorized Volkswagen dealer or an authorized Volkswagen Service Facility.

Serious personal injury may result from improperly performed work.

### More information:

- Trailer towing
- Working in the engine compartment
- Parts, accessories, repairs and modifications

### WARNING

#### Engine coolant is poisonous!

- Always keep the coolant in its original container stored in a safe place.
- To reduce the risk of poisoning, never store engine coolant in empty food or beverage containers or in any other containers that might mislead someone into drinking from them.
- Always keep engine coolant out of reach of children.
- Always make sure there is enough of the correct coolant additive to provide proper anti-freeze protection at the coldest temperatures that can be expected where the vehicle will be used.
- At extremely cold temperatures, the coolant could freeze, causing the vehicle to break down. The heater would also not work, and vehicle occupants could be without protection at subfreezing temperatures.



Coolant and coolant additives can pollute the environment. Collect leaking operating fluids and dispose of them properly in accordance with applicable environmental laws and regulations.

## Warning light and engine coolant temperature gauge

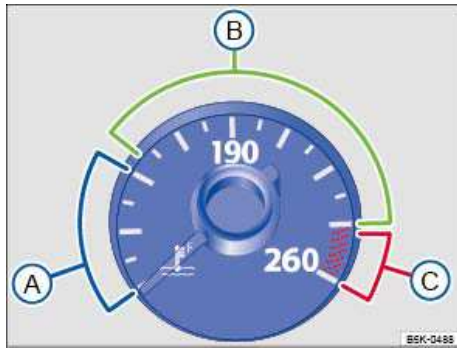

**Fig. 318** Engine coolant temperature gauge in the instrument cluster: A Engine cold, B normal temperature range, C warning zone.

**⚠ Please first read and note the introductory information and heed the WARNINGS ⚠**



If the indicator in the engine coolant temperature gauge is located in the cold range (A), the engine has not reached operating temperature. High engine speeds and heavy engine loads should be avoided.

Under normal driving conditions, the needle should be in the middle of the gauge. The temperature may go higher when the engine is working hard, especially in hot weather.

When the ignition is switched on, several warning and indicator lights come on briefly for a function check. They go out after a few seconds.

The following table explains what to do if the engine coolant warning light  does not go out a few seconds after the engine is started or lights up or starts flashing while driving.

Flashes	Temperature gauge needle ⇒ <a href="#">fig. 318</a>	Possible cause	Proper response

Flashes	Temperature gauge needle ⇒ fig. 318	Possible cause	Proper response
	<p>(C) Warning zone</p>	<p>Engine coolant temperature too high.</p>	<p> <b>Stop!</b>  Pull off the road and stop as soon as you can do so safely. Stop the engine and let it cool down until the temperature needle is in the normal range again. Check the engine coolant level and add coolant if needed.  If the engine coolant level is correct or the problem continues after adding coolant and driving a short distance, <b>do not drive any farther.</b> Contact the nearest authorized Volkswagen dealer or authorized Volkswagen Service Facility.  If the coolant level is correct, the overheating may be caused by a radiator fan fault. Check the fuses and replace as necessary.</p>

Flashes	Temperature gauge needle ⇒ fig. 318	Possible cause	Proper response
	(B) Normal range	Engine coolant level too low.	<p>Check the engine coolant level after the engine has cooled down and add engine coolant if low.</p> <p>If the engine coolant level is correct or the problem continues after adding coolant, <b>do not drive any farther.</b> Contact an authorized Volkswagen dealer or authorized Volkswagen Service Facility.</p> <p>These instructions apply only when the coolant temperature stays in the normal range. Stop immediately if the needle goes into the red warning zone (C).</p>
	–	Engine coolant system malfunction.	<p> <b>Stop!</b></p> <p>Get assistance from an authorized Volkswagen dealer, an authorized Volkswagen Service Facility, or another qualified workshop.</p>
–	(A) Cold range	The engine has not yet warmed up.	Do not drive at high engine speeds or with heavy engine loads until the engine warms up.

When the ignition is switched on, several warning and indicator lights come on briefly for a function check. They go out after a few seconds.



## WARNING

Failure to heed warning lights and instrument cluster text messages can cause the vehicle to break down in traffic and result in a collision and serious personal injury.

- Never ignore warning lights or text WARNINGS.
- Always stop the vehicle as soon as it is safe to do so.



## NOTICE

Failure to heed warning lights or text WARNINGS can result in vehicle damage.

## Engine coolant specifications

 Please first read and note the introductory information and heed the WARNINGS 

The engine cooling system is filled at the factory with a mixture of specially conditioned water and at least 40 percent of Volkswagen engine coolant additive **G13** (TL-VW 774 J). This engine coolant additive is pink.

This mixture provides antifreeze protection down to -13 °F (-25 °C). It also helps to protect the light alloy parts in the engine cooling system against corrosion. In addition, the mixture helps prevent calcium deposits and increases the boiling point of the engine coolant.

To protect the engine, the mixture must *always* contain *at least 40% coolant additive* even in warm weather or climates where antifreeze protection is not needed.

If more antifreeze protection is needed for climate conditions, the percentage of coolant additive can be increased. However, the coolant additive percentage must never be more than 60%; otherwise, antifreeze protection is reduced and the ability of the mixture to cool the engine is also reduced.

When adding engine coolant, use a mixture of **distilled** water and at least 40% coolant additive G 13 or G 12 plus-plus (TL-VW 774 G) for optimum corrosion protection ⇒ .

Do not mixing G 13 with G 12 plus, or G 11. Mixing these coolant additives together significantly reduces corrosion protection ⇒  and can lead to engine damage that is not covered by any Volkswagen Limited Warranty.



## WARNING

Too little antifreeze protection in the engine cooling system can cause engine failure and severe injuries.

- Always make sure there is enough of the correct coolant additive to provide proper antifreeze protection at the coldest temperatures that can be expected where the vehicle will be used.
- At extremely cold temperatures, the coolant could freeze, causing the vehicle to break down. The heater would also not work, and vehicle occupants could be without protection at subfreezing temperatures.



## NOTICE

Never mix original Volkswagen engine coolant additives with other additives not approved by Volkswagen. Mixing Volkswagen coolant additives with coolant additives made by other manufacturers can seriously damage the engine and the engine cooling system.

- If the fluid in the engine coolant reservoir is any color but pink, then G 13 was mixed with a different engine coolant. If this is the case, the engine coolant must be replaced immediately. Otherwise serious malfunctions or engine damage can occur!

 Engine coolant and engine coolant additives can pollute the environment. Collect leaking operating fluids and dispose of them properly in accordance with applicable environmental laws and regulations.

## Checking engine coolant level and topping off

---



Fig. 319 Coolant expansion tank in the engine compartment.





Fig. 320 Coolant expansion tank cap in the engine compartment.

 Please first read and note the introductory information and heed the WARNINGS 

If the coolant level drops too low, the engine coolant level/temperature warning light lights up.





### Preparations

- Park the vehicle on level ground.
- Always let the engine cool down ⇒ .
- Open the engine hood .
- There is a  symbol on the cap of the engine coolant expansion tank ⇒ fig. 320.

### Checking engine coolant level

- When the engine is cold, check the engine coolant level relative to the marking on the side of the expansion tank ⇒ [fig. 319](#).
- If the coolant level in the tank is below the minimum mark (“min”), add coolant. When the engine is warm, the engine coolant level may be slightly above the upper edge of the marked range.

### Adding engine coolant

- Always protect face, hands and arms from hot escaping coolant or steam by covering the cap with a large, thick rag.
- Carefully unscrew the cap ⇒ .
- Add only **new** engine coolant according to Volkswagen specifications ( *Engine coolant specifications*) ⇒ .
- The engine coolant level must be inside the marks on the side of the reservoir ⇒ [fig. 319](#). **Do not fill above the top edge of the filling range!** ⇒ .
- Screw the lid tightly.
- Even in an emergency, **do not** use any other kind of coolant additive if engine coolant meeting Volkswagen specifications (*Engine coolant specifications*) is unavailable! Instead, add **distilled water only** ⇒ . As soon as possible, have the correct coolant ratio restored using engine coolant that meets Volkswagen specifications ⇒ *Engine coolant specifications*.



### WARNING

Hot steam and hot engine coolant can cause serious burns.

- **Never open the hood if you see steam or coolant escaping from the engine compartment. Always wait until you no longer see or hear steam or coolant escaping from the engine.**
- **Always let the engine cool down completely before carefully opening the hood. Hot components will burn skin on contact.**
- **When the engine has cooled down and you are ready to open the hood:**
  - Apply the electronic parking brake and shift the transmission into Park (P).
  - Take the vehicle key out of the ignition.
  - On vehicles with Keyless Access , make sure that the remote control vehicle key is out of range of the vehicle and that the vehicle cannot be started by depressing the starter button ⇒ *Starter button*.
  - Always keep children and others away from the engine compartment and never leave them unsupervised.
- **The engine coolant system is under pressure when the engine is hot. Never unscrew the coolant expansion tank cap when the engine is hot. Hot coolant can spray out and cause severe burns and other serious injuries.**
  - Turn the cap slowly and very carefully in a counterclockwise direction while applying light downward pressure on the top of the cap.
  - Always protect your face, hands, and arms from hot escaping coolant or steam by covering the cap with a large, thick rag.
- **Never spill fluids on the engine or exhaust system when refilling. Spilling fluids onto hot parts of the engine or exhaust system can cause a fire. Under some conditions, the ethylene glycol in engine coolant can catch fire.**



 NOTICE

- Use distilled water only when adding coolant! All other types of water contain chemical compounds that can cause extensive corrosion damage to the engine. This can even lead to engine failure. If you have added non-distilled water, take the vehicle immediately to an authorized Volkswagen dealer or an authorized Volkswagen Service Facility to have the coolant system drained, flushed, and refilled completely with the proper coolant.
- Refill engine coolant only up to the top edge of the marked fill range ⇒ [fig. 319](#). Excess engine coolant may be forced out of the engine cooling system when it gets hot and cause damage.
- In the case of significant engine coolant loss, refill engine coolant only when the engine is *completely cooled down*. Significant engine coolant loss is a sign of leaks in the cooling system. Have the engine cooling system checked immediately by an authorized Volkswagen dealer or an authorized Volkswagen Service Facility. Otherwise the engine may be damaged!
- When changing or topping off operating fluids, make sure that you pour the fluids into the correct reservoirs. Serious malfunctions and engine damage can result if you pour operating fluids into the wrong reservoir.

## 12 Volt vehicle battery

### Introduction

---

In this section you'll find information about:

Warning light

Charging, replacing, disconnecting and connecting the 12 Volt vehicle battery

The standard 12 Volt vehicle battery is part of the vehicle electrical system.

Never do any work on the vehicle electrical system unless you





- know exactly how to carry out the job,
- have the correct technical information and the proper tools, and
- are familiar with the necessary safety precautions ⇒  !

If you are uncertain in any way, have the work done by an authorized Volkswagen dealer or an authorized Volkswagen Service Facility. Serious personal injury may result from improperly performed work.

#### Location of the vehicle battery

The 12 Volt vehicle battery is located under the left front seat.

#### Explanation of the warnings on the vehicle battery

Symbol	Meaning
	Always wear eye protection!
	Battery acid is highly corrosive. Always wear protective gloves and eye protection!
	Fire, sparks, open light and smoking are prohibited!
	When a battery is charged, it produces hydrogen gas which is highly explosive!
	Always keep children away from battery acid and vehicle batteries!

#### More information:

- ⇒ Booklet *Warranty and Maintenance*
- Working in the engine compartment

- Interior care and cleaning
- Parts, accessories, repairs and modifications

### **WARNING**

Working on the batteries or the electrical system in your vehicle can cause serious acid burns, fires, explosions, or electrical shocks. Always read and heed the following WARNINGS and safety precautions before working on the batteries or the electrical system.

- Before working on the electrical system, always switch off the ignition and all electrical consumers and disconnect the negative cable (-) from the standard 12 Volt vehicle battery.
- When you change a light bulb, always switch off the light first.
- Always keep children away from battery acid and vehicle batteries in general.
- Always wear eye protection. Never let battery acid or lead particles come into contact with your eyes, skin, or clothing.
- Sulfuric battery acid is very corrosive. It can burn unprotected skin and cause blindness. Always wear protective gloves and eye protection. To reduce your risk of injury, never tilt the batteries, as this could spill acid through the vents and burn you.
- If you get battery acid in your eyes or on your skin, immediately rinse with cold water for several minutes and then get immediate medical attention. If you swallow any battery acid, get medical attention immediately.
- When disconnecting the batteries from the vehicle electrical system, always disconnect the negative cable (-) first and then the positive cable (+).
- Always switch off all electrical consumers before reconnecting 12 Volt vehicle batteries. Reconnect the plus cable (+) first and then the negative cable (-). Never reverse the polarity of the connections. This could cause a fire.
- A highly explosive mixture of gases is given off when the battery is being charged.
- Do not smoke and avoid fires, sparks, and open flames when working. Never create sparks or electrostatic charges when handling cables and electrical equipment. Never short circuit the battery terminals. High-energy sparks can cause serious personal injury.
- Never use or attempt to charge a damaged or frozen battery, or a battery that was frozen but has thawed. Charging a frozen or thawed battery could cause explosions and chemical burns! Replace damaged or frozen vehicle batteries immediately. A dead battery can freeze at temperatures around +32 °F (0 °C).
- If the battery has a vent line or tube, make sure that this it is properly connected to the battery.
- Always make sure that the vent line is securely attached to a vehicle battery that is located in the luggage compartment.

### **WARNING**

California Proposition 65 Warning

- Battery posts, terminals, and related accessories contain lead and lead components, chemicals known to the State of California to cause cancer and reproductive harm. Wash your hands after handling.



### **NOTICE**

- Do not expose the vehicle battery to direct sunlight for an extended period of time as ultra-violet rays may damage the battery housing.
- If the vehicle is left standing in the cold for a long time, protect the vehicle battery from freezing. A battery will be permanently damaged by freezing.

 Emergency starting and starting the engine with a very weak vehicle battery or after the vehicle battery has been replaced may change or delete system settings (including time, date, personal convenience settings and programming). Check the settings and correct as necessary once the vehicle battery has built up a sufficient charge.

## Warning light

 Please first read and note the introductory information and heed the **WARNINGS** 

Lights up	Possible cause	Proper response
	Alternator malfunction.	<p>See an authorized Volkswagen dealer or an authorized Volkswagen Service Facility. Have the electrical system checked.</p> <p>Switch off all electrical consumers that are not needed. The vehicle battery will not be charged by the alternator as you drive.</p>
	Deactivation of electrical consumers.	<p>Drive for a longer distance at a somewhat higher than normal engine speed (rpm). While doing this, do not switch on features that consume a lot of electricity (such as the rear window defroster).</p> <p>If the indicator light still stay on, see an authorized Volkswagen dealer or an authorized Volkswagen Service Facility and have the electrical system checked.</p>

When the ignition is switched on, several warning and indicator lights come on briefly for a function check. They go out after a few seconds.

## **WARNING**

Failure to heed warning lights and instrument cluster text messages can cause the vehicle to break down in traffic and result in a collision and serious personal injury.

- Never ignore warning lights or text WARNINGS.
- Always stop the vehicle as soon as it is safe to do so.

## **NOTICE**

Failure to heed warning lights or text WARNINGS can result in vehicle damage.

## Charging, replacing, disconnecting and connecting the 12 Volt vehicle battery

---

 Please first read and note the introductory information and heed the WARNINGS 

### Charging the vehicle battery

Vehicle batteries should be charged by an authorized Volkswagen dealer or an authorized Volkswagen Service Facility because the factory-installed battery requires a charger with overload protection ⇒ .

### Replacing the vehicle battery

The battery in your vehicle is specially developed for its location, with special dimensions and safety features. Before buying a new battery, ask an authorized Volkswagen dealer or authorized Volkswagen Service Facility what batteries are suitable with regard to electro-magnetic compatibility, dimensions, required maintenance, performance, and safety specifications. Have the battery replaced by an authorized Volkswagen dealer or an authorized Volkswagen Service Facility.

Only use maintenance-free vehicle batteries meeting standards TL 825 06 and VW 7 50 73. These standards must date from August 2008 or later.

### Checking the electrolyte level

The 12 Volt vehicle battery is located under the left front seat, do not check the electrolyte level. Specialized knowledge and tools are required to access the vehicle battery. For this reason, have an authorized Volkswagen dealer or an authorized Volkswagen Service Facility check the electrolyte level of the vehicle battery for you.

### Disconnecting the vehicle battery

If the battery must be disconnected from the vehicle's electrical system, note the following:

- Switch off all electrical systems and devices and the ignition.
- Unlock the vehicle before disconnecting the battery; otherwise the alarm system will go off.
- First disconnect the negative cable (-) and then the positive cable (+) ⇒ .

### Connecting the vehicle battery

- Prior to reconnecting the battery, switch off all electrical systems and devices and the ignition.
- Connect the positive cable (+) first and then the negative cable (-) ⇒ .

After the battery is connected and the ignition is switched on, different indicator lights may come on. They should go out after you drive a short distance at 10 – 12 mph (15 – 20 km/h). If the indicator lights do not go out, contact an authorized Volkswagen dealer or an authorized Volkswagen Service Facility and have the vehicle checked.

If the battery was disconnected for a long time, the next scheduled service may not be correctly calculated and displayed. The maximum permissible service and maintenance intervals are shown in the ⇒ Booklet *Warranty and Maintenance*.

### **Vehicles with Keyless Access**

If the ignition will not start after reconnecting the vehicle battery, lock the vehicle from the outside and unlock it again. Then try to start the ignition again. If the ignition cannot be switched on, contact an authorized Volkswagen dealer, an authorized Volkswagen Service Facility, or another qualified workshop for assistance.

### **Automatic electrical load deactivation**

If the vehicle battery drain is high, the intelligent on-board electrical system management automatically takes steps to help prevent battery drain.

- The idle speed is increased so that the alternator provides more power.
- The power to devices that consume a lot of electricity is cut back or switched off completely.
- When the engine is started, the power supply to the 12 Volt sockets and the cigarette lighter is temporarily interrupted.

The on-board electrical system management cannot always keep the battery from being drained. For example, the battery will drain if the engine is not running, but the ignition is switched on or the parking lights are left on for a long time when parked.

### **Battery disconnection in an accident with airbag deployment**

In vehicles with a battery in the luggage compartment, the electrical connection to the battery is disconnected automatically in a collision with airbag deployment. This helps to prevent a short-circuit.

### **What drains the vehicle battery?**

- Long periods when the engine is not running, especially when the ignition is on.
- Using electrical systems or devices when the engine is switched off.
- Leaving the vehicle unlocked for several days when not in use.
- The selector lever is left for a long period of time in any position other than **(P)** when the ignition is switched off ⇒ *Automatic transmission: Selector lever*.

### **WARNING**

**Failure to use the proper battery with proper mounting and connections may cause short circuits, fires, and serious personal injuries.**

- **Always use only maintenance-free or cycle-free, leak-proof batteries with the same specifications and dimensions as the original equipment battery. Specifications are listed on the battery housing.**

### **WARNING**

**When the vehicle battery is charged, it produces highly explosive hydrogen gas.**

- **Charge vehicle batteries only in well-ventilated areas.**
- **Never charge a frozen or thawed battery. A dead battery can freeze at temperatures around +32 °F (0 °C). Always replace a battery that has frozen.**
- **You must replace the vehicle battery if it was frozen.**
- **Incorrectly connected cables can cause a short-circuit. First connect the positive cable (+) and then the negative cable (-).**



## NOTICE

- **Never disconnect a vehicle battery or connect 2 vehicle batteries to each other when the ignition is switched on or the engine is running. Using the wrong battery can damage the electrical system or electronic components and cause electrical malfunctions.**
- **Never use a vehicle battery that does not meet specifications for the vehicle battery for your vehicle. Using the wrong battery can damage the electrical system or electronic components and cause electrical malfunctions.**
- **Never connect power generating equipment, such as a solar panel or battery charger, to the 12 Volt socket in order to charge the vehicle battery. This can damage the vehicle's electrical system.**



Dispose of the vehicle battery according to regulations. Vehicle batteries contain poisonous substances such as sulfuric acid and lead.



Battery acid can pollute the environment. Catch leaking operating fluids and dispose of them properly.

# Exterior care and cleaning

## Introduction

---

In this section you'll find information about:

- Washing the vehicle
- Washing with a power washer
- Cleaning windows and outside mirrors
- Cleaning and changing the windshield wiper blades
- Waxing and polishing vehicle paint
- Caring for and cleaning chrome and aluminum parts
- Cleaning wheel rims
- Care of rubber door and window seals
- Deicing door lock cylinders
- Cleaning the power sunroof and the sunshade
- Undercoating
- Cleaning the engine compartment

Regular and expert care helps to **preserve the value** of your vehicle. Such expert care may also be one of the requirements of your New Vehicle Limited Warranty if corrosion repair or repainting is necessary.

Vehicle care products are available from your authorized Volkswagen dealer or Authorized Volkswagen Service Facility.

### **More information:**

- Working in the engine compartment
- Interior care and cleaning
- Parts, accessories, repairs and modifications



### **WARNING**

**Vehicle care products can be dangerous. Improper use can cause accidents, burns, poisoning, or other serious personal injuries.**

- **Always store vehicle care products only in original containers that are securely closed.**
- **Always read and heed all the instructions and all WARNINGS on the package.**
- **To reduce the risk of poisoning, never use empty food or beverage containers that might mislead someone into drinking from them.**
- **Always keep vehicle care products out of the reach of children.**
- **Always use such products outdoors or in well-ventilated areas, because harmful vapors may be released when these products are used.**
- **Never use fuel, turpentine, engine oil, nail polish remover or other volatile fluids for vehicle care. They are poisonous and highly flammable.**



## WARNING

**Improper care and cleaning of vehicle components can impact the safety features of the vehicle and cause severe injuries.**

- Always clean and maintain vehicle components according to manufacturer's instructions.
- Only use approved or recommended cleaners.

## NOTICE

**Vehicle care products containing solvents can damage plastics and other vehicle materials.**



Wash the vehicle only at specifically designated wash locations to prevent water contaminated with oil, grease and fuel from entering the storm drain sewer system. In some areas it is against the law to wash motor vehicles anywhere other than at specified designated car washing locations.



When buying vehicle care products, try to choose those that are not harmful to the environment.



Never throw out vehicle care products with ordinary household waste. Always read and heed all the instructions and all WARNINGS on the package.

## Washing the vehicle

---

 Please first read and note the introductory information and heed the WARNINGS 

The longer insect splatter, bird droppings, tree sap, road dirt, industrial deposits, tar, soot, road salt, and other aggressive materials stay on your vehicle, the more damage they do to the paint finish. High temperatures (including strong sunlight) increase the corrosive effects. The vehicle **underbody** should also be washed regularly and thoroughly.

### Car wash

**Pay close attention to the information provided by the car wash operator.** Before going through a car wash, be sure to take the usual precautions to help prevent damage, such as closing the windows, folding back the outside mirrors, etc. If you have installed additional accessories on the vehicle, such as spoiler, a roof rack, or an antenna, always ask the car wash operator, if this poses a problem ⇒ .

The paint finish is tough enough that the vehicle can normally be washed without problems in an automatic car wash. However, the effect on the paint depends to a large extent on the type of car wash. Volkswagen recommends using brushless car wash facilities.

To remove wax residue from the windows and avoid jerky windshield wiper movement, heed the following tips ⇒ *Cleaning windows and outside mirrors.*

### Washing by hand

When washing by hand, first soften the dirt with plenty of water and then rinse off as much dirt as possible.

Then clean the vehicle with a soft **sponge**, a **washing glove** or **brush** using only light pressure. Start on the roof and work down. Use special **shampoo** only on hard-to-remove dirt or grime.

Rinse the sponge or glove thoroughly and often.

Clean the wheels and under the door sills last. Use a different sponge or wash mitt.

### WARNING

After the vehicle has been washed, the wet brakes or, in winter, brake discs or pads coated with ice, react slower and need longer stopping distances.

- Always dry the brakes and clean off any ice coatings with a few careful applications of the brake. Make sure not to endanger other motorists or cyclists or disobey legal requirements.

### CAUTION

Sharp edges under the vehicle can cut exposed skin.

- Always protect your hands and arms from cuts on sharp metal edges when cleaning the underbody, the inside of the wheel housings, etc.

### NOTICE

- The water temperature must not be more than +140 °F (+60 °C).
- To help prevent damage to the paint, do not wash the vehicle in direct sunlight.
- Do not use insect sponges, abrasive kitchen sponges or similar things to clean the vehicle. These can damage the paint finish.
- Never clean headlights with a dry cloth or sponge. Always use a wet cloth or sponge. For best results use soapy water.
- When washing or rinsing the vehicle in cold weather, do not let water get into the lock cylinders or point the hose at gaps around the doors, hood or rear hatch. The water could freeze on the locks and seals and make it difficult to open the vehicle!

### NOTICE

To help prevent vehicle damage in a car wash:

- Compare the vehicle track width with the dimensions of the guide rails in the car wash to help prevent damage to wheel rims and tires!
- Switch off the rain sensor before driving through a car wash.
- Make sure there is enough clearance for the height and width of the vehicle.
- To help prevent paint damage to the engine hood, place wiper blades against the windshield after they have dried. Do not let them snap back into place.
- Fold the outside mirrors toward the vehicle body. Do not fold power mirrors manually!
- Lock the rear hatch to prevent unintentional opening in the car wash.

## Washing with a power washer

 Please first read and note the introductory information and heed the WARNINGS 

Always follow the instructions for the power washer. This especially applies to the **pressure** and **spraying distance** ⇒ .

Make sure there is enough distance to soft materials such as rubber hoses or insulating material as well as the sensors of the Park Distance Control system. The park distance control system sensors are in the rear and front bumper ⇒ .

Never use **concentrated jet nozzles** or so-called **dirt blasters** ⇒ .

Never use a power washer to clean the engine compartment ⇒ *Cleaning the engine compartment.*

### **WARNING**

Improper use of power washers can cause serious invisible permanent damage leading to tire failure and loss of vehicle control. This can cause accidents and severe personal injury.

- Keep sufficient distance between water jet and tires. Never wash tires with a nozzle that sprays the water out in a direct stream regardless of the distance to the tire and even for a very short time.
- Never use “dirt blasters.” to clean tires. Even spraying from a relatively long distance for a very short time can do visible or invisible damage to tires.

### **WARNING**

After the vehicle has been washed, the wet brakes or, in winter, brake discs or pads coated with ice, react slower and need longer stopping distances.

- Always dry the brakes and clean off any ice coatings with a few careful applications of the brake. Make sure not to endanger other motorists or cyclists or disobey legal requirements.

### **NOTICE**

- Water temperature should not be more than 140° F (60° C).
- To help prevent damage to the paint, do not wash the vehicle in direct sunlight.
- In order for Park Distance Control to work correctly, the sensors in the bumpers must be kept clean and clear of snow and ice.
- When using a power washer or steam cleaner, only spray the rear assist sensors directly for a short period of time and always keep the nozzle at least 4 inches (10 cm) from the sensor.
- Do not clean icy or snow-covered windows with a power washer.
- When washing or rinsing the vehicle in cold weather, do not let water get into the lock cylinders or point the hose at gaps around the doors, hood or rear hatch. The water could freeze on the locks and seals and make it difficult to open the vehicle!

## Cleaning windows and outside mirrors

 Please first read and note the introductory information and heed the **WARNINGS** 

### **Cleaning windows and outside mirrors**

Spray windows and outside mirrors with a commercially available alcohol-based window cleaner.

Dry windows and mirrors with a clean chamois or a lint-free cloth. Do not use a chamois that has been used to wipe painted surfaces because it will have absorbed an oily residue that will smear the glass surfaces.

Use window cleaner or a silicone remover to remove rubber, oil, grease and silicone deposits ⇒ .

### **Removing wax residue**

Automatic car washes and vehicle care products can leave a **wax residue** on all glass surfaces.

These wax residues can only be removed with special cleaners or cleaning cloths. Wax residue left on the windshield can cause the windshield wipers to grab and squeak instead of gliding smoothly. We

recommend that after every car wash you remove any wax residue left on the windshield with a cleaning cloths/chamois G 052 522 A1 or equivalent.

Windshield wiper squeak and grab can be reduced by filling the windshield washer fluid tank with a wiper fluid containing wax-removing agents. Make sure to maintain the proper mixing ratio when refilling the washer fluid tank. Grease-removing cleaning agents cannot remove wax residue ⇒ ⚠.

Special cleaners or cleaning cloths are available from your authorized Volkswagen dealer and authorized Volkswagen Service Facility.

### Removing snow

Remove snow from all windows and outside mirrors with an appropriate brush.

### Removing ice

The best way to remove ice is with a deicer spray. When using an ice scraper always scrape in one direction, **never** back and forth. Dirt can scratch the window when moving the scraper backward.



### WARNING

Dirty or fogged up windows reduce visibility and increase the risk of accidents and severe injuries.

- Don't drive until you have clear visibility through all windows.
- Remove ice, snow and condensation from all inside and outside window surfaces.



### NOTICE

- Never mix recommended cleaning agents with other cleaning agents in the windshield washer reservoir. If you do, this could cause sediments or other by-products that can clog the windshield wiper nozzles.
- Never use warm or hot water to remove snow and ice from windows and mirrors. This could cause the glass to crack!
- The heating elements for the rear defroster are on the inside of the rear window. Do not put stickers over the heating elements on the inside of the rear window and never clean the inside of the windows with corrosive or acidic cleaning agents or other chemicals that could damage the heating elements.
- Antennas installed on the insides of windows can be damaged by abrasive objects or by corrosive or acidic cleaning agents or other chemicals. Do not place any stickers on the windshield-integrated antenna and never clean the antenna with corrosive or acidic cleaning agents or other chemicals.

## Cleaning and changing the windshield wiper blades

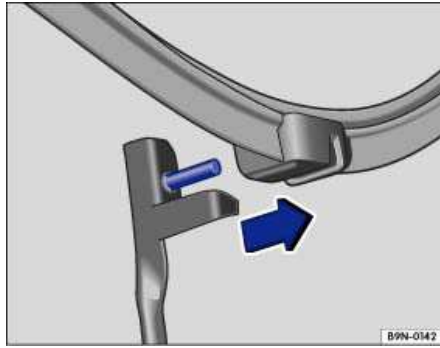

Fig. 321 Changing the windshield wiper blades.



Fig. 322 Changing the rear window wiper blades.

**⚠ Please first read and note the introductory information and heed the WARNINGS ⚠**

Factory-installed wiper blades have a graphite coating. The graphite coating lets the wiper blades glide smoothly over the windshield. If this coating is worn or damaged, the wipers may grab or squeak.

Check all wiper blades regularly. **Wiper blades that grab and squeak** must be replaced if worn or damaged and cleaned if dirty ⇒ ⚠.

Replace worn or damaged wiper blades immediately. Replacement blades may be purchased from any authorized Volkswagen dealer or authorized Volkswagen Service Facility.

### Lifting and tilting windshield wiper arms

Move the wiper arms into the service position before lifting them away from the windshield ⇒ *Windshield wiper and washer*.

It is not possible to lift the wiper arms away from the windshield when they are not in the service position.

When lifting or replacing a wiper blade on a window, grip it **only** by its mounting and not by the blade itself.

### Cleaning the wiper blades

- Lift the wiper arm(s) away from the windshield/rear window.
- Using a soft cloth, carefully remove dust and dirt from the wiper blades.
- If the blades are very dirty, carefully clean them with a sponge or cloth ⇒ ⚠.

- Carefully fold the wiper arm back down onto the window.

#### Changing wiper blades

- Lift the wiper arm(s) away from the windshield.
- Tilt the wiper blade 90 ° clockwise to the wiper arm and pull off the wiper blade ⇒ [fig. 321](#).
- Install a new wiper blade of **same length and type** onto the wiper arm by pushing in the opposite direction of the arrow until it latches.
- Carefully fold the wiper arm back down onto the windshield.

#### Changing the rear window wiper blade

- Lift the wiper arm away from the rear window.
- Pull the wiper blade and the retainer out of the holder.
- Install a new wiper blade of **same length and type** onto the wiper arm by pushing in the opposite direction of the arrow ⇒ [fig. 322](#) until it latches.
- Carefully fold the wiper arm back down onto the rear window.

 <b>WARNING</b>
<p><b>Worn or dirty wiper blades reduce visibility and increase the risk of accidents and severe injuries.</b></p> <ul style="list-style-type: none"> <li>• <b>Always change wiper blades if they are damaged or worn, and if they cannot clean the windows sufficiently.</b></li> </ul>

 <b>NOTICE</b>
---

- **Damaged or dirty wiper blades can scratch the windshield and the rear window.**
- **Solvents, abrasive sponges and sharp-edged objects will damage the graphite coating on the wiper blades.**
- **Do not clean the windows with gasoline, nail polish remover, paint thinner or similar fluids.**
- **To help prevent damage to the engine hood and the windshield wiper arms, lift the wiper arms away from the windshield only when they are in the service position.**

## Waxing and polishing vehicle paint

 **Please first read and note the introductory information and heed the WARNINGS **

### Waxing

A good coat of wax helps to protect the vehicle paint. When water no longer forms small drops and **runs off** when the paint is *clean*, apply a new coat of good **hard wax** to protect the vehicle again.

Even if a **wax solution** is used regularly at the car wash, Volkswagen recommends applying a coat of hard wax at least twice a year to protect the paint.

### Polishing

Polish your vehicle if the paint has lost its shine and the gloss cannot be brought back with wax.

The vehicle must be waxed after polishing if the polish used does not contain wax compounds to seal the paint.

## NOTICE

- To help prevent damage, do not use hard wax or polish on matte-finished parts, plastic parts, headlights or rear lights.
- Do not wax or polish your vehicle if it is dirty, or in a sandy or dusty place.

## Caring for and cleaning chrome and aluminum parts

---

 Please first read and note the introductory information and heed the WARNINGS 

- Clean the surface using a clean, soft, lint-free cloth dampened with water.
- If the surface is especially dirty, use a special **solvent-free** cleaning material.
- Then polish chrome and aluminum parts with a soft, dry cloth.

## NOTICE

To help prevent damage to chrome and aluminum parts:

- Do not clean or polish in direct sunlight.
- Do not clean or polish in sandy or dusty places.
- Do not use abrasive cleaners or abrasive sponges.
- Do not use cleaning materials that contain solvents.
- Do not polish dirty surfaces.
- Do not use hard wax.

## NOTICE

Chrome wheel covers and hubcaps have an extra coating. Do not treat them with chrome care or polishing products. Use regular paint care and polishing products.

## Cleaning wheel rims

---

 Please first read and note the introductory information and heed the WARNINGS 

### Cleaning steel wheels

Stubborn brake dust can be removed with an industrial cleaner. Clean steel wheels regularly with a separate sponge.

Repair any paint damage on steel wheels before rust begins to form.

### Cleaning alloy wheels

**Every 2 weeks:** Wash road salt and brake dust off alloy wheels, and clean the wheels with an acid-free detergent. **Every 3 months:** Volkswagen recommends applying a hard wax compound to the wheels.

If road salt and brake dust are not removed regularly, they can corrode the metal.

Use an acid-free detergent specifically designed for light alloy wheels. Do not use car polish or other abrasive products.

If the protective coating is damaged, for example by stone impact, repair the damaged area right away.

## Care of rubber door and window seals

ⓘ Please first read and note the introductory information and heed the WARNINGS ⚠

The rubber seals around the doors and windows will stay soft and flexible, seal better and last longer if the seals are treated regularly with a suitable rubber care product.

Before applying the treatment, use a soft cloth to remove dust and dirt from the rubber seals.

ⓘ Do not apply any rubber care products to the rubber seals on the body in the areas around the windows in the driver's and front passenger's doors. The product could run down onto the windows and smudge them.

## Deicing door lock cylinders

ⓘ Please first read and note the introductory information and heed the WARNINGS ⚠

Volkswagen recommends using only genuine Volkswagen deicer spray with lubricating and anti-corrosive properties to deice door lock cylinders.

### ⚠ NOTICE

Lock deicers that contain grease solvents can cause the lock cylinder to rust.

## Cleaning the power sunroof and the sunshade

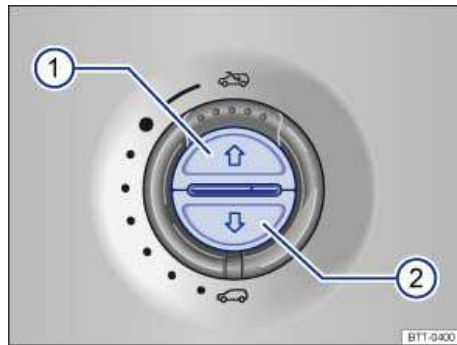

Fig. 323 In the headliner: Buttons for sunshade.

ⓘ Please first read and note the introductory information and heed the WARNINGS ⚠

Dirt and debris can impair the function of the power sunroof.

The power sunroof only works when the ignition is on. You can still open or close the power sunroof for several minutes after you switch off the ignition, as long as the driver or front passenger door has not been opened.

### Moving the sunshade to the cleaning position

- Park the vehicle safely.



- Open the power sunroof completely ⇒ page 64.
- Press and hold the button ⇒ fig. 323 (2) for about 5 seconds until the sunshade is completely closed.
- If the sunshade is heavily soiled, carefully clean it with a cloth and warm water.

### NOTICE

Close the power sunroof completely before driving off. Driving with the sunshade in the cleaning position can lead to damage to the vehicle.

### NOTICE

Do not attempt to clean the drain tubes for the power sunroof. This could result in vehicle damage caused by punctured or damaged drain tubes.

 Remove leaves and other objects from the sunroof guide rails regularly either by hand or using a vacuum cleaner.

## Undercoating

 Please first read and note the introductory information and heed the WARNINGS 

The vehicle underbody is coated to help protect it from corrosion and damage. The undercoating could be damaged during normal use. We therefore recommend that you have the protective coatings on the underbody and suspension inspected regularly, and repaired if necessary.

### WARNING

Undercoating and rustproofing products can catch fire on the hot exhaust system or any other hot engine component.

- Never apply additional undercoating or rustproofing on or near the exhaust manifold, the exhaust pipes, the catalytic converter, the heat shields, or any other hot vehicle component

## Cleaning the engine compartment

 Please first read and note the introductory information and heed the WARNINGS 

The engine compartment of a vehicle is a dangerous area ⇒ *Working in the engine compartment*.

If necessary, the engine compartment should be cleaned by an authorized Volkswagen dealer or authorized Volkswagen Service Facility. Incorrect cleaning procedures could remove corrosion protection and damage electrical components, among other things. In addition, water could enter directly into the vehicle interior through the plenum chamber ⇒ .

Never use a power washer to clean the engine compartment ⇒ .

If the engine compartment is extremely dirty, have it cleaned professionally by your authorized Volkswagen dealer or authorized Volkswagen Service Facility.

### Plenum chamber

The plenum chamber is located in the engine compartment between windshield and engine, under a perforated cover. Outside air is taken into the vehicle interior from the plenum chamber via the climate control system.

Regularly remove leaves and other loose objects from the plenum chamber cover by hand or with a vacuum cleaner.



#### WARNING

**Injuries, scalding, electric shock, accidents and fire hazards can occur while working on the engine or in the engine compartment!**

- Before working in the engine compartment, be sure to familiarize yourself with the necessary procedures and generally accepted safety precautions ⇒ page 570, *Working in the engine compartment*.
- Volkswagen recommends having the work performed by an authorized Volkswagen dealer or authorized Volkswagen Service Facility.



#### NOTICE

**Spraying or pouring water (e.g. with power washer) into the plenum chamber can cause severe damage to the vehicle.**



Wash the engine compartment only in special wash bays so that the oily dirt and fuel residue that are washed off the vehicle will not enter the sewage system. In some areas it is illegal to wash the engine compartment anywhere other than at such specified locations.

## Interior care and cleaning

### Introduction

---

In this section you'll find information about:

- Caring for upholstery
- Cleaning upholstery, fabric trim and Alcantara®
- Care and cleaning of leather upholstery
- Cleaning leatherette
- Cleaning storage compartments and cup holders
- Care and cleaning of plastic components, wood trim and instrument panel
- Cleaning the safety belts

Modern clothing fabrics such as dark denim may not be completely colorfast. Even with normal use, dye from these and other fabrics can rub off on seat upholstery and leave visible discolorations (especially on light-colored seat upholstery). This is caused by a lack of colorfastness in the clothing fabric, not by any fault in the seat upholstery fabric. To help prevent damage to the seat upholstery, always make sure your clothing is colorfast. Volkswagen recommends having a qualified specialist remove any discolorations from the seat upholstery.

The longer stains, dirt and other deposits remain on the surfaces of vehicle components and upholstery, the more difficult it may be to clean them. If stains, dirt and deposits are left untreated for a long period of time, they may become impossible to remove.

#### **More information:**

- Exterior care and cleaning
- Parts, accessories, repairs and modifications

#### **WARNING**

**Vehicle care products can be dangerous. Improper use can cause accidents, burns, poisoning, or other serious personal injuries.**

- **Always store vehicle care products only in original containers that are securely closed.**
- **Always read and heed all the instructions and all WARNINGS on the package.**
- **To reduce the risk of poisoning, never use empty food or beverage containers that might mislead someone into drinking from them.**
- **Always keep vehicle care products out of the reach of children.**
- **Always use such products outdoors or in well-ventilated areas, because harmful vapors may be released when these products are used.**
- **Never use fuel, turpentine, engine oil, nail polish remover or other volatile fluids for vehicle care. They are poisonous and highly flammable.**



## WARNING

Improper care and cleaning of vehicle components can compromise the vehicle's safety features and cause severe injuries.

- Always clean and maintain vehicle components according to manufacturer's instructions.
- Only use approved or recommended cleaners.



## NOTICE

- Vehicle care products containing solvents can cause irreparable damage to plastics and other vehicle materials.
- Stains, dirt and other deposits that contain aggressive substances or solvents can corrode vehicle materials and cause permanent damage, even after brief contact with the surface.
- Remove stains, dirt, and other deposits as quickly as possible and do not allow them to dry.
- To help prevent damage, have stubborn stains removed by a professional who has the necessary expertise and experience.



Suitable care products are available from authorized Volkswagen dealers and authorized Volkswagen Service Facilities.

## Caring for upholstery

 Please first read and note the introductory information and heed the **WARNINGS** 

### Checklist

Please note the following when it comes to the care and preservation of the upholstery ⇒ 

- ✓ Open Velcro® fasteners can damage upholstery fabric, and trim. Before you get into the vehicle, close all Velcro® fasteners that could come into contact with upholstery fabrics and cloth trim.
- ✓ Sharp-edged objects and items on clothing and belts (such as belt clips, mobile phone cases, zippers, rivets, and rhinestones) can damage upholstery material and fabric trim. To help prevent damage, do not let such items come into direct contact with the upholstery and fabric trim.
- ✓ Dust and dirt particles in pores, folds, and seams can have a “scouring” effect on material and damage the surface. Remove dust and dirt regularly to help prevent permanent surface damage.
- ✓ Check clothing for color-fastness to help prevent upholstery discoloration, especially to light-colored upholstery.



## NOTICE

Disregarding the upholstery-related checklist may lead to damage or discoloration of upholstery and fabric trim.

- Please note and follow the points listed in the checklist.



Volkswagen recommends having any discoloration removed by an authorized Volkswagen dealer or authorized Volkswagen Service Facility.

## Cleaning upholstery, fabric trim and Alcantara®

📖 Please first read and note the introductory information and heed the WARNINGS ⚠️

### Cleaning upholstery on heated seats and power seats or seats with airbag components

Airbag components and electrical connectors may be installed in the driver seat, the front passenger seat. Damaging, cleaning and handling incorrectly, or wetting or soaking these seat surfaces and backrests can damage the vehicle electrical system and prevent the airbag system from working properly ⇒ ⚠️.

Electrical components and connectors that could be damaged by incorrect cleaning or handling are installed in power seats and heated seats ⇒ ⚠️. This can also result in damage to other parts of the vehicle electrical system.

For this reason, read and follow these cleaning instructions:

- Do not use pressure washers, steam cleaners, or cooling spray.
- Do not use detergent pastes or mild detergent solutions.
- Do not wet the surface completely.
- Only use cleaning products approved by Volkswagen.
- If you have questions or concerns, consult a professional cleaner.
- Before using any cleaning agent, familiarize yourself with instructions and warnings on the packaging.
- Vacuum upholstery, fabric trim, Alcantara® upholstery, and carpeting regularly with a suitable brush attachment.
- A soft sponge or a commercially available lint-free microfiber cloth may be used for general cleaning ⇒ ⚠️.
- Clean Alcantara® surfaces with a damp cotton or wool cloth or a commercially available lint-free microfiber cloth ⇒ ⚠️.

Upholstery and fabric trim with light generalized soiling can be cleaned with a commercially available dry-foam cleaner.

If the upholstery fabric and fabric trim pieces are heavily soiled, see your authorized Volkswagen dealer or authorized Volkswagen Service Facility before you begin cleaning to learn about suitable cleaning options. If necessary, have the cleaning done by a professional.

### Cleaning upholstery on non-heated seats, manual seats, or seats without airbag components

- Before using any cleaning agent, familiarize yourself with instructions and warnings on the packaging.
- Vacuum upholstery, fabric trim, Alcantara® upholstery, and carpeting regularly with a suitable brush attachment.
- Do not use pressure washers, steam cleaners, or cooling spray.
- A soft sponge or a commercially available lint-free microfiber cloth may be used for general cleaning ⇒ ⚠️.
- Clean Alcantara® surfaces with a damp cotton or wool cloth or a commercially available lint-free microfiber cloth ⇒ ⚠️.

Upholstery and fabric trim with light generalized soiling can be cleaned with a commercially available dry-foam cleaner.

If the upholstery fabric and fabric trim pieces are heavily soiled, see your authorized Volkswagen dealer or authorized Volkswagen Service Facility before you begin cleaning to learn about suitable cleaning options. If necessary, have the cleaning done by a professional.

## Removing stains

When treating stains, it may be necessary to clean the entire surface and not just the stain itself. This is especially true if the entire surface has become dirty from normal use. Otherwise, the area that is treated may become lighter than the untreated area. If you have questions or concerns, consult a professional cleaner.

Type of stain	Recommended cleaning for fabric and upholstery
<i>Water-based stains</i> , such as coffee or fruit juice.	<ul style="list-style-type: none"><li>– Moisten a sponge with water and rub the stain gently with a circular motion.</li><li>– Wipe dry with an absorbent cloth.</li></ul>
<i>Persistent stains</i> , such as chocolate or make-up.	<ul style="list-style-type: none"><li>– Use only Volkswagen-approved cleaning products.</li><li>– If necessary, have the fabric or upholstery professionally cleaned.</li></ul>
<i>Grease-based stains</i> , such as oil, lipstick, etc.	<ul style="list-style-type: none"><li>– Use only Volkswagen-approved cleaning products.</li><li>– If necessary, have the fabric or upholstery professionally cleaned.</li></ul>



### WARNING

If there is a malfunction in the airbag system, the airbag may not deploy correctly or at all, or it may deploy unexpectedly. This could cause fatal injuries.

- Have the airbag system inspected immediately by your authorized Volkswagen dealer or authorized Volkswagen Service Facility.



### NOTICE

If the upholstery on power seats, heated seats, or seats with airbag components is wet, electrical components and the vehicle electrical system could be damaged.

- If the seating surface becomes soaked, have it dried and the system components checked immediately by an authorized Volkswagen dealer or authorized Volkswagen Service Facility.
- Do not use steam cleaners because the steam could cause the dirt to penetrate deeper into the fabric and make it impossible to remove.
- Pressure washers and cooling sprays can damage the upholstery.



### NOTICE

- Clean only the carpet and floor mats with brushes. Other textile surfaces can be damaged by brushes.
- If detergent pastes or mild detergent solutions are applied with a damp cloth or sponge, the surfactants in the detergent may cause visible lines to form at the edges of the area where the detergent was applied. These lines are generally difficult or impossible to remove.

 **NOTICE**

- Do not soak Alcantara®.
- Do not treat Alcantara® with leather care products, solvents, floor wax, shoe polish, stain remover or similar products.
- Do not use brushes for damp cleaning, because they can damage upholstery surfaces.
- Do not use a steam cleaner, because dirt will penetrate deeper into the fabric.

## Care and cleaning of leather upholstery

 Please first read and note the introductory information and heed the **WARNINGS** 

If you have questions regarding the care and cleaning of the leather upholstery in the vehicle, please contact an authorized Volkswagen dealer or authorized Volkswagen Service Facility.

### Care and treatment

Natural leather requires special attention and care. Napa leather has a smooth surface. The intensity of the color application determines the leather's appearance and texture. If you can see the leather grain and other natural characteristics, this is an untreated napa leather that will provide very comfortable seating. Delicate veins, closed scars, insect bites, folds, and a slightly clouded color remain visible and represent authentic characteristics of the natural material. Untreated napa leather has no protective coating. It is therefore more susceptible to damage. You should keep this in mind if the leather is going to be exposed to severe wear from children, animals, or other factors. By contrast, leather that has a protective coating is more robust. This has a positive effect on the leather's durability in daily use. The typical natural characteristics are hardly visible or no longer visible at all, but that has no impact on the quality of the leather itself. The typical characteristics of untreated leather are much more distinctive than those of a surface-treated leather.

- After each cleaning, apply cream that waterproofs the leather and protects it against the sun. Such creams also nourish the leather, let it breathe, keep it flexible and moisturized. At the same time it protects the surface.
- Clean leather every 2 to 3 months and remove any new stains.
- Treat leather with a suitable leather-care product twice a year ⇒ .
- Apply cleaning and conditioning materials sparingly and always with a dry, lint-free cotton or wool cloth. Do not apply cleaning and conditioning materials directly to the leather.
- Remove fresh stains such as ballpoint pen, lipstick, ink, shoe polish, etc. as soon as possible.
- Preserve the leather's color. If necessary, refresh fading spots with a specially-colored leather cream.
- Wipe the leather with a soft cloth.

### Cleaning

Volkswagen recommends using a slightly moistened cotton or wool cloth for general cleaning.

It is important not to let water soak through the leather or penetrate into seams.

**Before cleaning** leather surfaces, read and heed the information ⇒ page 612, *Cleaning upholstery on heated seats and power seats or seats with airbag components*.

Type of stain	Cleaning
---------------	----------

Type of stain	Cleaning
<i>Heavy stains</i>	<ul style="list-style-type: none"> <li>– Apply a mild soapy solution with a cloth that has been wrung nearly dry<sup>41</sup>.</li> <li>– Dab dry with an absorbent cloth.</li> </ul>
<i>Water-based stains</i> , such as coffee, tea, juice, or blood.	<ul style="list-style-type: none"> <li>– Remove fresh stains with an absorbent cloth.</li> <li>– If the stains are already dry, use an appropriate cleaning agent ⇒ ⚠.</li> </ul>
<i>Grease-based stains</i> , such as oil, lipstick, etc.	<ul style="list-style-type: none"> <li>– Remove fresh stains with an absorbent cloth.</li> <li>– Use an appropriate cleaning agent on stains that have not yet penetrated the surface ⇒ ⚠.</li> </ul>
<i>Special stains</i> , such as ballpoint pen, marker, nail polish, latex paint, or shoe polish.	<ul style="list-style-type: none"> <li>– Dab dry with an absorbent cloth.</li> <li>– Clean with a special stain remover designed for leather.</li> </ul>



#### NOTICE

- Stains that have been left in place too long will penetrate the surface of the leather and cannot be removed.
- Never treat leather with solvents, floor wax, shoe polish, stain remover or similar products.
- Wipe up spilled liquids immediately with an absorbent cloth. Liquid can penetrate leather surfaces and seams within a few seconds.
- If the vehicle is left in the sun for a long time, cover the upholstery to protect the leather from direct sunlight and to help prevent fading and discoloration.



Slight discoloration caused by wear and tear is normal.

### Cleaning leatherette

📖 Please first read and note the introductory information and heed the WARNINGS ⚠

Clean leatherette upholstery only with water and a mild soap solution.

**Before cleaning** leatherette surfaces, read and heed the information ⇒ page 612, *Cleaning upholstery on heated seats and power seats or seats with airbag components*.

<sup>41</sup> Mild soap solution: 2 tablespoons of liquid soap in one quart of water.



## ! NOTICE

- Do not clean leatherette with solvents, floor wax, shoe polish, stain remover, or similar products.
- These can cause the material to become brittle and break. Sharp-edged objects and items on clothing and belts (such as belt clips, mobile phone cases, zippers, rivets, and rhinestones) can damage upholstery material and fabric trim.
- If the vehicle is left in the sun for a long time, cover the upholstery to protect the leatherette from direct sunlight and to help prevent fading or discoloration.

## Cleaning storage compartments and cup holders

---

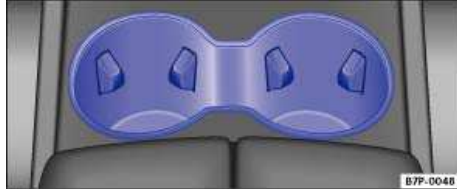

Fig. 324 In the lower front center console: Front cup holders.

ⓘ Please first read and note the introductory information and heed the WARNINGS ⚠

### Cleaning storage compartments and cup holders

Some storage compartments and cup holders ⇒ fig. 324 have a removable rubber insert at the bottom.

- Moisten a clean, lint-free cloth with water and clean the parts.
- If this is not sufficient, then use a special **solvent-free** care and cleaning product designed for plastics.

## Care and cleaning of plastic components, wood trim and instrument panel

---

ⓘ Please first read and note the introductory information and heed the WARNINGS ⚠

- Moisten a clean, lint-free cloth with water and clean the parts.
- Clean *plastic components (inside and outside of the vehicle) and the instrument panel* only with a **solvent-free** care and cleaning product that is specifically designed for plastics and approved by Volkswagen ⇒ ⚠.
- Clean *wood trim* with a mild soap solution.



## WARNING

Using solvents or other improper cleaning products on surfaces where airbags are located can change the way airbags deploy in a crash.

- Products containing solvents will change the properties of the plastics and may cause plastic parts to break and fly around when the airbag deploys in a crash, causing injury.
- Never use solvents or cleaners on the steering wheel horn pad or on the instrument panel because they can damage the airbag cover or change the stiffness or strength of the material so that the airbag cannot deploy and protect properly.
- When cleaning the horn pad and instrument panel, use only a soft, dry cloth or a cloth moistened with plain water.

## Cleaning the safety belts

 Please first read and note the introductory information and heed the WARNINGS 

If a safety belt is dirty, this can prevent the belt from working properly. Keep safety belts clean and regularly check all safety belts for damage.

Safety belts must never be taken apart for cleaning.

- Remove coarse dirt with a soft brush ⇒ .
- Carefully pull the dirty safety belt out of the retractor and keep it out.
- Clean the safety belt with a *mild* soap solution.
- After cleaning, always give the safety belts time to dry thoroughly before letting them retract. This helps prevent damage to the retractor.
- Do not let the safety belts retract until they are completely dry.



## WARNING

Damage to safety belts reduces their overall effectiveness and increases the risk of serious personal injury and death whenever the vehicle is being used.

- Check the condition of all safety belts regularly. If you notice that the safety belt webbing, hardware, retractor, buckle, or any other part of the safety belts is damaged, immediately have an authorized Volkswagen dealer or authorized Volkswagen Service Facility replace the safety belt with the correct replacement belt for your vehicle model and model year.
- Never use chemical cleaning agents, solvents, or any substance that may damage or weaken the safety belt webbing or any other parts of the safety belt. Never let the belts come into contact with corrosive fluids or sharp objects. Otherwise, the safety belt webbing will be significantly weakened.
- After cleaning, always give the safety belts time to dry completely before letting them retract. The moisture can damage the retractor and keep it from working properly.
- Never let foreign objects or liquids get into the safety belt latch. This could prevent the belt buckles and safety belts from working properly.
- Damaged safety belts must be replaced; they cannot be repaired.
- Never try to repair a damaged safety belt yourself. Never remove or modify the safety belts in any way.
- Safety belts that were subject to stress in an accident and stretched must be replaced with a correct, new safety belt, preferably by an authorized Volkswagen dealer or authorized Volkswagen Service Facility.
- Replacement after a crash may be necessary even if a safety belt shows no visible damage. Anchorages that have been loaded must also be inspected.

# Parts, accessories, repairs and modifications

## Introduction

---

In this section you'll find information about:

Break-in period

Parts and accessories

Operating fluids and equipment

Repairs and technical modifications

Repairs and other things that can affect Advanced Airbag performance

Notice about data recorded by vehicle control modules

Notice about data recorded by the Event Data Recorder and vehicle control modules

Using the mobile phone without a vehicle integrated antenna - some important things to know

### **More information:**

- Safety belts
- Airbag system
- Roof rack
- Trailer towing
- Tire Pressure Monitoring System (TPMS)
- Power outlets
- Braking and parking
- Starting assistance systems
- Cruise control system (CCS)
- Selective catalytic reduction (AdBlue®)
- Working in the engine compartment
- Engine oil
- Engine coolant
- 12 Volt Vehicle battery
- Exterior care and cleaning
- Interior care and cleaning
- Consumer information



## WARNING

Inappropriate spare parts and accessories as well as unprofessionally performed work, modifications and repairs can cause vehicle damage, accidents and serious personal injuries.

- Volkswagen strongly recommends to only use accessories approved by Volkswagen and Genuine Volkswagen Parts®. These parts and accessories have been evaluated by Volkswagen for their suitability, reliability and safety.
- Have repairs and vehicle modifications performed by an authorized Volkswagen dealer or authorized Volkswagen Service Facility. Authorized Volkswagen dealers and authorized Volkswagen Service Facilities have the required tools, diagnostic equipment, repair information, and trained personnel to properly replace any airbag in your vehicle and assure system effectiveness in a crash.
- Only install parts on the vehicle that are consistent with factory-installed parts with respect to design and characteristics.
- Never store, mount or attach objects, such as cup or phone cradles, on or next to the airbag module covers or within the airbags deployment zones.
- Only use wheel rim/tire combinations approved by Volkswagen for the respective vehicle type.

## Break-in period

---

ⓘ Please first read and note the introductory information and heed the WARNINGS ⚠

Note applicable requirements for breaking in new parts.

### Breaking in a new engine

A new engine must be carefully broken in during the first 1,000 miles (1,600 kilometers). During the first few hours of driving, the engine's internal friction is higher than later when all moving parts have been broken in.

Engine life is influenced by how you drive the vehicle for the first 1,000 miles (1,500 km). Even afterwards, driving at moderate engine speeds, especially when the engine is cold, will tend to reduce engine wear and help the engine to last longer and go farther. But do not drive at an excessively low engine speed, either. Always downshift if the engine is not running smoothly. **For the first 600 miles (1000 km):**

- Do not use full throttle.
- Don't let the engine speed get above 2/3 of the maximum speed.
- Do not tow a trailer.

**From 600 to 1000 miles (1000 to 1600 km):** Speed may *gradually* be increased to maximum permissible road and engine speed.

### New tires and brake pads

- New tires and replacement tires ⇒ *Tires and wheels*
- Brakes ⇒ *About the brakes*



Breaking in a new engine gently, will increase service life and reduce oil consumption.

## Parts and accessories

---

ⓘ Please first read and note the introductory information and heed the WARNINGS ⚠

Volkswagen recommends that you consult an authorized Volkswagen dealer or authorized Volkswagen Service Facility before purchasing accessories, spare parts or other equipment. Always do so if you want to install additional accessories or replace parts. Your authorized Volkswagen dealer or authorized Volkswagen Service Facility can provide information about legal requirements and factory-recommended accessories, spare parts, and other equipment.

### **WARNING**

**Improper vehicle modifications and repairs affect the performance of the airbag system and cause malfunctions and severe personal injuries.**

- **Never store, mount or attach objects, such as cup holders or phone cradles, on or next to the airbag module covers or within the airbag deployment zones.**
- **Objects on or near the surface where airbags are located can come loose and cause serious personal injury if the airbag deploys.**

## Operating fluids and equipment

 Please first read and note the introductory information and heed the **WARNINGS** 

**Operating fluids and parts that wear out with use** (such as timing belts, tires, engine coolants, engine oils, spark plugs, and vehicle batteries) are constantly being improved. For this reason, it is important to have operating fluids changed and wearing parts replaced by an authorized Volkswagen dealer or authorized Volkswagen Service Facility. Authorized Volkswagen dealers and authorized Volkswagen Service Facilities are always up-to-date regarding new developments and changes.

### **WARNING**

**Improper use of operating fluids and equipment can cause accidents, serious personal injuries, burns and/or poisoning.**

- **Always store vehicle care products in a safe place in original containers that are securely closed.**
- **To reduce the risk of poisoning, never use empty food or beverage containers that might mislead someone into drinking from them.**
- **Always keep vehicle care products out of the reach of children.**
- **Always read and heed all the instructions and all WARNINGS on the package before using vehicle care products.**
- **When using products that give off harmful fumes, always work outdoors or in a well ventilated area.**
- **Never use fuel, turpentine, engine oil, nail polish remover or other volatile fluids for vehicle care. They are poisonous and highly flammable. They could cause fires and explosions!**

### **NOTICE**

- **Only refill with suitable operating fluids. When changing or topping off fluids, make sure that you pour the fluids into the correct reservoirs. Adding incorrect fluids will cause serious malfunctions and engine damage! Under no circumstances should you mix up operating fluids. Otherwise serious malfunctions and engine damage can occur!**
- **Accessories and other things installed in front of the cooling air intakes impair the efficiency of the engine coolant. The engine can overheat under high ambient temperatures or under high engine loads!**



Leaking operating fluids can pollute the environment. Collect leaking operating fluids in suitable containers and dispose of them properly in accordance with applicable environmental laws and regulations.

## Repairs and technical modifications

---

📖 Please first read and note the introductory information and heed the **WARNINGS** ⚠️

**Volkswagen guidelines for repairs and technical modifications must be followed** ⇒ ⚠️ !

Changes to electronic components and related software can cause malfunctions. These malfunctions can also affect other systems that are related to the component or software that was modified. The vehicle's operational safety can be seriously jeopardized, increased vehicle component wear can occur, and the vehicle may no longer meet applicable emissions requirements.

Volkswagen recommends having all repairs and technical modifications performed by an authorized Volkswagen dealer or authorized Volkswagen Service Facility using **Genuine Volkswagen Parts**®.

Damage that is caused by improper repairs or unapproved technical modifications will not be covered by any Volkswagen Limited Warranty.



### WARNING

**Improperly performed repairs and modifications can cause vehicle damage and malfunctions, and can impair the efficiency of driver assistance systems. This can lead to accidents and severe personal injuries.**

- Have repairs and vehicle modifications done by an authorized Volkswagen dealer or authorized Volkswagen Service Facility.



### NOTICE

**Improperly performed repairs and modifications can cause increased component wear and result in vehicle emissions that no longer meet applicable requirements.**

## Repairs and other things that can affect Advanced Airbag performance

---

📖 Please first read and note the introductory information and heed the **WARNINGS** ⚠️

Repairs and modifications of front bumpers, doors, front seats, headliners and the chassis can affect proper airbag performance and should be performed by an authorized Volkswagen dealer or authorized Volkswagen Service Facility. These vehicle areas can contain important parts of the airbag system.

Components of the airbag system can be damaged during removal, assembly and repair activities on the airbag system itself or related components. Damage to airbag parts can prevent the system from working properly in a collision.

Observe all regulations so that the effectiveness of the airbag is not affected and to prevent disassembled parts from causing injuries and pollution. Authorized Volkswagen dealers, authorized Volkswagen Service Facilities, and other qualified workshops are familiar with these regulations.

Changing the vehicle's suspension system can change the way that the airbag system works in a crash. For example, using tire-rim combinations not approved by Volkswagen, lowering the vehicle, changing the stiffness of the suspension, including the springs, suspension struts, shock absorbers etc. can change the forces that are measured by the airbag sensors and sent to the electronic control

unit. Some suspension changes can, for example, increase the force levels measured by the airbag sensors and send to the electronic control unit and make the airbag system deploy in crashes in which it would not deploy if the changes had not been made. Other kinds of changes may reduce the force levels measured by the sensors and prevent the airbag from deploying when it should.

Never install leather upholstery on a vehicle that originally had cloth upholstery. Never install cloth upholstery on a vehicle that originally had leather upholstery. The weight-sensing mat for the Advanced Airbag system will not work properly if different upholstery is installed on the passenger seat than the upholstery originally installed on the vehicle when it was originally manufactured.

 **WARNING**

**Changing the vehicle's suspension including use of unapproved tire-rim combinations can change airbag performance and increase the risk of serious personal injury in a crash.**

- Never install suspension components that do not have the same performance characteristics as the components originally installed on your vehicle.
- Never use tire-rim combinations that have not been approved by Volkswagen.

 **WARNING**

**Leaving the optional safety belt extender attached to the safety belt buckle on the front passenger seat when the safety belt is not being used will prevent the Advanced Airbag System from working properly and can increase the risk of serious personal injury in a collision.**

- Leaving the extender attached to the safety belt buckle when the front seat is occupied and the safety belt is not being used will signal to the airbag control unit that the front passenger seat is occupied and that the safety belt is being used. The electronic control unit for the airbag system will then receive incorrect information that will
  - cause the safety belt pretensioner to deploy unnecessarily in collisions and
  - cause the front passenger airbag to deploy later in collisions in which the front airbag would otherwise be triggered earlier to help protect an unrestrained front seat passenger.
- Always remove the safety belt extender when it is not needed and stow it safely.
- Never use the safety belt extender to secure a child restraint.

 **WARNING**

**Items stored between the safety belt buckle and the center console can cause safety belt buckle to send the wrong information to the airbag control unit and prevent the Advanced Airbag System from working properly.**

- Always make sure that nothing can interfere with the safety belt buckles and that they are not obstructed.



## WARNING

Improper care and servicing, and improper modification and repair work, can increase the risk of personal injury and death by preventing an airbag from deploying when needed or deploying an airbag unexpectedly:

- Never repair, adjust, or change any parts of the airbag system.
- All work on the airbag system, steering wheel, instrument panel, front seats or electrical system (including the installation of audio equipment, cellular telephones and CB radios, etc.) should be performed by authorized Volkswagen dealers or authorized Volkswagen Service Facilities. They have the necessary manuals, training, and special equipment.
- The airbag system can be activated only once. After an airbag has inflated, it must be replaced.
- Use only original equipment airbags approved by Volkswagen. Have them installed by a trained technician who has the necessary tools and diagnostic equipment to properly replace any airbag in your vehicle and assure system effectiveness in a crash.
- Never permit salvaged or recycled airbags to be installed in your vehicle.



Undeployed airbag modules and safety belts pretensioners are classified as **Perchlorate Material** – Special handling may apply. Obey all legal requirements regarding handling and disposal of these components – see <http://www.dtsc.ca.gov/hazardouswaste/perchlorate>. Obey all applicable legal requirements regarding handling and disposal of the vehicle or parts of its restraint system, including airbag modules and safety belts with pretensioners. Authorized Volkswagen dealers and authorized Volkswagen Service Facilities are familiar with the requirements, and we recommend that you have them perform this service for you.

## Notice about data recorded by the Event Data Recorder and vehicle control modules

---

### Please first read and note the introductory information and heed the WARNINGS

This vehicle is equipped with an Event Data Recorder (EDR). The main purpose of an EDR is to record, in certain crash or near crash-like situations, such as an airbag deployment or hitting a road obstacle, data that will assist in understanding how a vehicle's systems performed. The EDR is designed to record data related to vehicle dynamics and safety systems for a short period of time, typically 30 seconds or less. The EDR in this vehicle is designed to record such data as:

- How various systems in your vehicle were operating;
- Whether or not the driver and passenger safety belts were buckled/fastened;
- How far (if at all) the driver was depressing the accelerator and/or brake pedal; and,
- How fast the vehicle was traveling.

These data can help provide a better understanding of the circumstances in which crashes and injuries occur. **NOTE:** EDR data are recorded by your vehicle only if a non-trivial crash situation occurs; no data are recorded by the EDR under normal driving conditions and no personal data (e.g., name, gender, age, and crash location) are recorded. However, other parties, such as law enforcement, could combine the EDR data with the type of personally identifying data routinely acquired during a crash investigation.

To read data recorded by an EDR, special equipment is required, and access to the vehicle or the EDR is needed. In addition to the vehicle manufacturer, other parties, such as law enforcement, that have the special equipment, can read the information if they have access to the vehicle or the EDR.

Some state laws restrict the retrieval or downloading of data stored by EDRs installed in a vehicle for the express purpose of retrieving data after an accident or crash event without the owner's consent.



Volkswagen will not access the EDR and/or similar data or give it to others - unless the vehicle owner (or lessee if the vehicle has been leased) agrees, or;

- upon the official request by the police;
- upon the order of a court of law or a government agency; or
- for the defense of a lawsuit through the judicial discovery process.

Volkswagen may also use the data for research about vehicle operation and safety performance or provide the data to a third party for research purposes without identifying the specific vehicle or information about the identity of its owner or lessee.

Your vehicle is also equipped with a number of electronic control modules for various vehicle systems, such as engine management, emission control, airbags, and safety belts.

These electronic control modules record data during normal vehicle operation that may be needed by trained technicians for diagnostic and repair purposes. The recording capability of these modules is limited to data (no sound is recorded). Only a small amount of data is actually recorded over a very limited period of time, or stored when a system fault is detected by a control module. Some of the data stored may relate to vehicle speed, direction, or braking, as well as restraint system use and performance in the event of a crash. Stored data can also only be read and downloaded with special equipment that is directly connected to the vehicle.

## Using the mobile phone without a vehicle integrated antenna - some important things to know

---

### **⚠ Please first read and note the introductory information and heed the WARNINGS ⚠**

Mobile or cellular telephones send and receive radio waves, sometimes called "radio frequency energy" (RF energy), both when they are being used and when they are in stand-by mode. Current scientific literature indicates that radio waves that exceed a certain level can have effects on the human body. Limits and guidelines have been established by governmental authorities and international committees in an effort to keep the electromagnetic radiation from mobile phones at levels that will not cause health problems. However, there is no scientifically based proof that wireless phones are absolutely safe.

Therefore some experts recommend a precautionary approach regarding the use of mobile phones by taking measures that lower the personal exposure to electromagnetic fields.

When using a cellular telephone inside a motor vehicle without a proper connection to an integrated vehicle telephone antenna, personal exposure to electromagnetic fields will be higher than when using the cellular telephone while properly connected to an integrated or other outside vehicle telephone antenna.

Your vehicle may be equipped with an optional hands-free system that will permit many of the features of compatible Bluetooth® enabled cellular telephones to be used for greater convenience and consistent with the laws of an increasing number of states and localities that prohibit the use of cellular telephones without some kind of hands-free device.

The hands-free system in your vehicle can be used with certain mobile phones that are connected by wire and hardware connector or via compatible Bluetooth® enabled phones with a cradle that is designed to fit your cellular telephone. The special cradle offers several advantages: The phone cradle must be safely secured to the base plate. Your phone is firmly attached to the instrument panel and is within reach at all times. Placing the phone in its cradle permits it to be charged, but more importantly connects the mobile phone to the vehicle's outside antenna. A cellular telephone that is properly connected to the integrated or other outside vehicle telephone antenna will lower the personal exposure to electromagnetic fields. You should also experience a better quality of service. Although a cellular telephone can be used inside your vehicle without a cradle, the phone will not be securely attached to the vehicle, will also not be charged through the cradle wiring, and more importantly will not be connected to the vehicle's integrated telephone antenna. The mobile phone will also not be recharged. You might also experience more dropped calls and an overall impaired quality of the connection.

Therefore we strongly recommend that you use your cellular telephone in your vehicle only when it is properly attached to an appropriate cradle mounted on a base plate on the instrument panel.

Because of the large number and variety of cellular telephones on the market and the frequency with which new models are introduced, Volkswagen does not offer cradles for cellular telephones. Please check with the manufacturer of the cellular telephone that you plan to use.



#### **WARNING**

**A mobile phone on the seat, instrument panel or in other places can be thrown around the inside of the vehicle during a sudden braking maneuver, a crash or other accident and injure vehicle occupants.**

- **Never place or attach accessories or other objects (such as cup holders, telephone brackets, note pads, navigation systems, large, heavy or bulky objects) on the doors, on the windshield, over or near the area marked "AIRBAG" on the steering wheel, instrument panel, backrests or between these areas and the occupant. Such objects could cause serious injury in a collision, especially if an airbag inflates.**



#### **WARNING**

**Using a mobile phone or CB radio inside the vehicle without a properly installed and separate outside antenna can be dangerous to your health and that of your passengers because the electromagnetic radiation energy that mobile phones and CB radios emit may be above established limits. This also applies if the outside antenna is not installed properly.**

- **Always keep the mobile phone antenna at least 8 inches (20 cm) away from pacemakers. Heart specialists advise that mobile phones can adversely affect the way of pacemakers work.**
- **Never carry a mobile phone that is switched on in the breast pocket directly over the pacemaker.**
- **If you suspect there may be interference with a pacemaker or other medical device, switch the mobile phone off immediately.**

## Consumer Information

### Introduction

---

In this section you'll find information about:

Operating your vehicle outside of the United States and Canada  
Radio antenna and reception  
UTQG classification  
Volkswagen service information

**More information:**

- Exterior views
- Technical data
- Starting assistance systems
- Parts, accessories, repairs and modifications

#### **WARNING**

**Improper vehicle care and use, as well as improper changes to the vehicle, increase the risk of accidents and injuries.**

- Obey all applicable legal requirements.
- Read your Owner's Manual and heed all WARNINGS.

#### **NOTICE**

**Improper handling of the vehicle can result in damage to the vehicle.**

- Obey all applicable legal requirements.
- Perform service according to the specifications in ⇒ Booklet *Warranty and Maintenance*.
- Read your Owner's Manual and heed all WARNINGS.

### Operating your vehicle outside of the United States and Canada

---

 Please first read and note the introductory information and heed the WARNINGS 

Government regulations in the United States and Canada require that automobiles meet specific emission regulations and safety standards. Therefore, vehicles built for the U.S. and Canada differ from vehicles sold in other countries.

If you plan to take your vehicle outside the continental limits of the United States or Canada, there is the possibility that:

- Unleaded fuels for vehicles with catalytic converters may not be available.
- Ultra Low Sulfur Diesel (ULSD) fuel No. 2 that your diesel engine requires may not be available.
- Fuel may have a considerably lower octane rating and may cause engine damage.
- Service may be inadequate due to lack of proper service facilities, tools or testing equipment.

- Replacement parts may not be readily available.
- DVD navigation systems for vehicles built for the United States and Canada will not necessarily work in Europe, and may not work in other countries outside of North America.

## NOTICE

**Volkswagen is not responsible for mechanical damage that may result from substandard fuel or service or the unavailability of Genuine Volkswagen parts.**

- **Volkswagen is not responsible if the vehicle does not meet the respective legal requirements in other countries and continents.**

## Radio antenna and reception

---

 **Please first read and note the introductory information and heed the WARNINGS **

If the vehicle has a factory-installed radio or navigation system, the radio antenna may be located at different places in the vehicle:

- On the inside of the rear window with the rear window defroster,
- On the inside of the rear side windows,
- On the inside of the windshield,
- On the vehicle roof.

Antennas on the insides of windows are thin wires.

## NOTICE

**Antennas installed on the insides of windows can be damaged by abrasive objects or by corrosive or acidic cleaning agents or other chemicals. Do not place any stickers on the windshield-integrated antenna and never clean the antenna with corrosive or acidic cleaning agents or other chemicals.**

 If electrical devices are operated close to the integrated windshield antenna, interference with AM radio reception may occur.

## UTQG classification

---

 **Please first read and note the introductory information and heed the WARNINGS **

Uniform Tire Quality Grading (UTQG): Quality grades can be found where applicable on the tire sidewall between the tread shoulder and maximum section width. Example:

- Treadwear (number)
- Traction: AA, A, B or C
- Temperature: A, B or C

For example: Treadwear 200, Traction AA Temperature A

All passenger car tires must conform to Federal Safety Requirements in addition to these grades.

### **Treadwear**

The tread wear grade is a comparative rating based on the wear rate of the tire when tested under controlled conditions on a specified government test course.

For example, a tire graded 150 (Tread wear-value 150) would wear one-and-one-half (1 1/2) times as well on the government course as a tire graded 100.

The relative performance of tires depends upon the actual conditions of their use, however, and may depart significantly from the norm due to variations in driving habits, service practices and differences in road characteristics and climate.

### **Traction**

The traction grades from highest to lowest, are AA, A, B and C. Those grades represent the tire's ability to stop on wet pavement as measured under controlled conditions on specified government test surfaces of asphalt and concrete. A tire marked C may have poor traction performance ⇒ ⚠.

### **Temperature**

The temperature grades are A (the highest), B, and C representing the tire's resistance to the generation of heat, and its ability to dissipate heat when tested under controlled conditions on a specified indoor laboratory test wheel.

Sustained high temperature can cause the material of the tire to degenerate and reduce tire life, and excessive temperature can lead to sudden tire failure.

The grade C corresponds to a level of performance which all passenger car tires must meet under the Federal Motor Vehicle Safety Standard No. 109. Grades B and A represent higher levels of performance on the laboratory test wheel than the minimum required by law ⇒ ⚠.

#### **⚠ WARNING**

**The traction grade assigned to this tire is based on straight-ahead braking traction tests, and does not include acceleration, cornering, hydroplaning or peak traction characteristics.**

#### **⚠ WARNING**

**The temperature grade for this tire is established for a tire that is properly inflated and not overloaded. Excessive speed, underinflation or excessive loading, either separately or in combination, can cause heat buildup and possible tire failure.**

## **Volkswagen service information**

---

📖 **Please first read and note the introductory information and heed the WARNINGS** ⚠

Volkswagen service information is published as soon as possible after model introduction.

To order service information contact:

Volkswagen Technical Literature Ordering Center

<http://www.vw.techliterature.com>

#### **⚠ WARNING**

**Improperly performed repairs and modifications can cause vehicle damage and malfunctions, and can impair the efficiency of driver assistance systems and the airbag system. This can lead to accidents and severe personal injuries.**

- **Have repairs and vehicle modifications performed by an authorized Volkswagen dealer or an authorized Volkswagen Service Facility.**

## Declaration of Compliance, Telecommunications and Electronic Systems

---

Radio Frequency Devices and Radio communication Equipment User Manual Notice.

### Radio-based equipment

- Mobile phone package.
- Electronic immobilizer.
- HomeLink Universal remote control.
- Remote control vehicle key.
- Tire Pressure Monitoring System (TPMS).
- Keyless Access locking and starting system.
- Park Distance Control (PDC) system.

### These devices comply with:

#### FCC Part 15.19

These devices comply with **Part 15 of the FCC Rules**. Operation is subject to the following 2 conditions:

- (1) This device may not cause harmful interference, and
- (2) this device must accept any interference received, including interference that may cause undesired operation.

#### FCC Part 15.21

##### CAUTION:

Changes or modifications not expressly approved by the party responsible for compliance could void the user's authority to operate the equipment.

These devices comply with **RSS-210 of Industry Canada**.

Operation is subject to the following 2 conditions:

- (1) this device may not cause interference, and
- (2) this device must accept any interference received, including interference that may cause undesired operation of the device.

The manufacturer is not responsible for any radio or TV interference caused by unauthorized modifications to this equipment.

Applicable only in the United States

## Reporting Safety Defects

---

If you believe that your vehicle has a defect which could cause a crash or could cause injury or death, you should immediately inform the National Highway Traffic Safety Administration (NHTSA) in addition to notifying Volkswagen of America, Inc. 3800 Hamlin Road, Auburn Hills, MI 48326.

If NHTSA receives similar complaints, it may open an investigation, and if it finds that a safety defect exists in a group of vehicles, it may order a recall and remedy campaign. However, NHTSA cannot become involved in individual problems between you, your dealer, or Volkswagen of America, Inc.

To contact NHTSA, you may call the Vehicle Safety Hotline toll-free at 1-888-327-4236 (TTY: 1-800-424-9153);

go to <http://www.safercar.gov>;

or write to:

Administrator  
NHTSA  
1200 New Jersey Avenue, SE.  
Washington, D.C. 20590

You can also obtain other information about motor vehicle safety from <http://www.safercar.gov>.

# Engine control and emission control system

## Introduction

---

In this section you'll find information about:

Indicator lights  
Catalytic Converter  
Diesel particulate filter

**More information:**

- Shifting gears
- Refueling
- Fuel
- Engine oil
- 12 Volt vehicle battery
- Towing

 **WARNING**

The vehicle exhaust system and the catalytic converter or diesel particulate filter get very hot. This can cause a fire and serious personal injury.

- Never park where parts of the hot exhaust system and catalytic converter could ignite flammable materials, such as brush, leaves, dry grass, spilled fuel, etc.
- Never apply additional undercoating or rustproofing on or near the exhaust manifold, exhaust pipes, catalytic converter, diesel particulate filter, or heat shields.

 **WARNING**

California Proposition 65 Warning

- Engine exhaust, some of its constituents, and certain vehicle components contain or emit chemicals known to the State of California to cause cancer and birth defects and reproductive harm. In addition, certain fluids contained in vehicles and certain products of component wear contain or emit chemicals known to the State of California to cause cancer and birth defects and reproductive harm.





## Indicator lights

---

 Please first read and note the introductory information and heed the WARNINGS 

Lights up	Possible cause	Proper response
-----------	----------------	-----------------



Lights up	Possible cause	Proper response
	Engine control malfunction (Electronic Power Control).	Have engine checked immediately by an authorized Volkswagen dealer or authorized Volkswagen Service Facility.
	Glow plug preheating before diesel engine start-up.	
	Engine control/monitoring system malfunction (engine Malfunction Indicator Light - MIL).	Ease off the accelerator. Carefully drive to the nearest authorized Volkswagen dealer or authorized Volkswagen Service Facility. Have engine checked.
	Diesel particulate filter clogged with soot.	<p>Drive about 15 minutes in Drive <b>(D)</b> (automatic transmission) at a speed of at least 45 mph (70 km/h).</p> <p>There may be a noticeable smell. Obey applicable speed limits ⇒ .</p> <p>See an authorized Volkswagen dealer or an authorized Volkswagen Service Facility if the indicator light is still on.</p>

Flashes	Possible cause	Proper response
	Engine control malfunction (diesel engine).	Have engine checked immediately by an authorized Volkswagen dealer or authorized Volkswagen Service Facility.

Flashes	Possible cause	Proper response
	Misfire, which can damage the catalytic converter.	Ease off the accelerator. Carefully drive to the nearest authorized Volkswagen dealer or authorized Volkswagen Service Facility. Have engine checked.

When the ignition is switched on, several warning and indicator lights come on briefly for a function check. They go out after a few seconds.

### **WARNING**

Obey all applicable legal requirements when cleaning the diesel particulate filter.

- Clean diesel particulate filter as recommended only when visibility, weather, road, and traffic conditions permit.
- Do not put others at risk.

### **NOTICE**

Failure to heed warning lights or text **WARNINGS** can result in vehicle damage.

 As long as the indicator lights , **EPC**, or  are on, expect engine malfunctions, increased fuel consumption and loss of engine efficiency.

## Catalytic Converter

 Please first read and note the introductory information and heed the **WARNINGS** 

The catalytic converter provides exhaust gas after-treatment to help reduce pollutants in the exhaust gas. To help ensure long service life of the exhaust system and gasoline engine catalytic converter:

- Only use unleaded fuel.
- Never run the fuel tank completely dry.
- Do not exceed the correct oil level ⇒ *Engine oil*.
- Do not tow the vehicle to start it, but use a jump-start instead ⇒ *Jump-starting*.

If you experience misfires, loss of power or the engine is not running smoothly while driving, reduce speed immediately and have the vehicle checked by an authorized Volkswagen dealer or authorized Volkswagen Service Facility. Otherwise, gasoline could reach the exhaust system and get into the atmosphere. The catalytic converter could also be damaged by overheating!



Under certain engine conditions, you may smell a sulfur odor. This is not an indication of a malfunctioning emission control system. This depends upon the sulfur content of the diesel fuel.

## Diesel particulate filter

 Please first read and note the introductory information and heed the WARNINGS 

The diesel particulate filter helps take soot particles out of the exhaust. The soot particles are collected and periodically burned in the filter at high temperatures (**regeneration**). The resulting heat can cause the temperature inside the engine compartment to increase.

Regeneration can create noises, slight smells, and, regardless of the outside temperature, cause the radiator fan to start – even after the engine has been turned off.

Volkswagen recommends frequently driving longer distances to help clean the filter. On vehicles with automatic transmissions, the engine speed may also increase slightly. The indicator light  will not come on.

To lengthen the life of the exhaust system and the diesel particulate filter:

- Use only Ultra Low Sulfur Diesel (ULSD) fuel No. 2 ⇒ *Fuel*.
- Never refuel with gasoline or fuel oil or bio-diesel that does not comply with the special requirements for diesel fuel
- Never drive until the fuel tank is completely empty.
- Do not exceed the correct oil level ⇒ *Engine oil*.
- Do not tow the vehicle to start, but use a jump-start instead ⇒ *Jump-starting*.

On vehicles with automatic transmissions, increase the engine speed slightly while driving to automatically start cleaning the diesel particulate filter. This helps to minimize clogging of the filter. The indicator light  will not come on.

### WARNING

**Obey all applicable legal requirements when cleaning (regenerating) the diesel particulate filter.**

- **Clean the diesel particulate filter as recommended only when visibility, weather, road, and traffic conditions permit.**
- **Do not put others at risk.**

 Under certain engine conditions, you may smell a sulfur odor. This is not an indication of a malfunctioning emission control system. This depends upon the sulfur content of the diesel fuel.

## Frequently asked questions

If you suspect a malfunction or vehicle damage, read and follow the following advice **before** contacting an authorized Volkswagen dealer or an authorized Volkswagen Service Facility. You may also find helpful information under “Characteristics” and “Checklist” in the index.

Description	Possible causes among others	Possible remedy
Engine does not start.	Vehicle battery dead.	<ul style="list-style-type: none"> <li>– Perform jump-start</li> <li>– Charge vehicle battery</li> </ul>
	The wrong remote control vehicle key is used.	Use a valid remote control vehicle key
	Fuel level too low.	Refuel
	AdBlue fill level too low.	Refill AdBlue
Vehicle cannot be locked or unlocked using remote control vehicle key.	<ul style="list-style-type: none"> <li>– Battery in remote control vehicle key dead.</li> <li>– Too far away from vehicle. (out of range).</li> <li>– Buttons have been pressed too many times.</li> </ul>	<ul style="list-style-type: none"> <li>– Replace battery</li> <li>– Move closer to vehicle.</li> <li>– Synchronize remote control vehicle key</li> <li>– Lock or unlock vehicle manually</li> </ul>
Unusual noises.	Cold engine, brake-assistance systems, electronic parking brake.	Check the “Noises” entry in the keyword index.
Odd driving behavior.	Assistance systems activated.	Check the “Assistance systems” entry in the keyword index.
Driver seat and outer mirrors move	Convenience settings are stored.	Correct convenience settings

Description	Possible causes among others	Possible remedy
when vehicle is unlocked.	Memory-seat settings are stored.	<ul style="list-style-type: none"> <li>– Reassign seat setting</li> <li>– Clear memory-seat memory</li> </ul>
Front seats cannot be adjusted with power controls.	Vehicle battery dead.	Charge vehicle battery
	Fuse blown.	Check fuse and replace if necessary
No jack in vehicle or no collapsible spare tire or tire mobility set in vehicle.	Equipment differs depending on vehicle.	No direct corrective action possible because this depends on the equipment. Contact an authorized Volkswagen dealer or an authorized Volkswagen Service Facility for assistance
	Vehicle has mobility tires.	
Features do not work as described in this Manual.	Settings were changed in the Volkswagen Information System or Infotainment System.	Check and reset to factory settings if necessary or
Headlights do not light up the road as they should.	<ul style="list-style-type: none"> <li>– Headlights incorrectly adjusted.</li> <li>– Light bulbs burned out.</li> <li>– Low beams not switched on.</li> </ul>	<ul style="list-style-type: none"> <li>– Adjust headlight range</li> <li>– Change light bulbs</li> <li>– Switch on low beams</li> </ul>
Electrical appliances do not work.	Vehicle battery charge too low.	Charge vehicle battery
	Remaining fuel level too low.	Refuel
	Fuse blown.	Check fuse and replace if necessary

Description	Possible causes among others	Possible remedy
Fuel consumption higher than indicated.	<ul style="list-style-type: none"> <li>– Short hauls.</li> <li>– “Jumpy accelerator pedal”.</li> </ul>	<ul style="list-style-type: none"> <li>– Avoid traveling short distances</li> <li>– Drive defensively.</li> <li>– Accelerate smoothly.</li> </ul>
	Electrical loads switched on.	Switch off unnecessary loads.
	Engine control malfunctioning.	Have the malfunction corrected.
	Tire pressure too low.	Adjust tire pressure
	Driving in the mountains.	No direct corrective action possible.
	Towing a trailer or roof rack.	<ul style="list-style-type: none"> <li>– Check use.</li> <li>– Remove if not in use.</li> </ul>
	Driving with heavy payload.	No direct corrective action possible.
	Driving at high engine speed.	Select a higher gear.

## Lift points for the vehicle

---

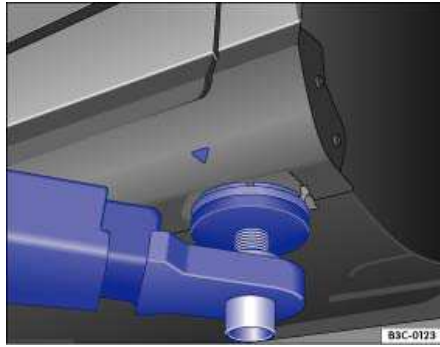

Fig. 325 Front lift point for workshop hoist or floor jack.

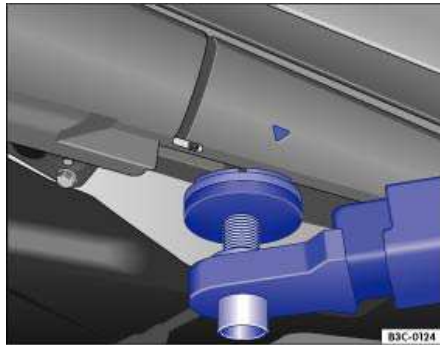

Fig. 326 Rear lift point for workshop hoist or floor jack.

The vehicle may only be raised at the lift points shown in illustrations and ⇒ [fig. 326](#). If the vehicle is lifted at different points, vehicle damage ⇒ ⚠ and serious injuries may occur ⇒ ⚠.

Workshop hoists that use fluid cushions (receiving platforms) must not be used for lifting the vehicle.

There are many precautions that have to be followed when lifting a vehicle on a workshop hoist or floor jack. Do not try to lift a vehicle on a workshop hoist or floor jack unless you have the training, knowledge, and experience to be able to do so safely.

Information about lifting the vehicle with the vehicle jack



## WARNING

Improperly lifting your vehicle with a workshop hoist or floor jack can cause the vehicle to fall off the hoist or jack and cause serious personal injury.

- Always read and heed the operating instructions from the floor jack manufacturer and legal regulations if necessary before using the floor jack to lift the vehicle.
- Never let anyone stay in the vehicle when it is being lifted or when it is off the ground.
- Always lift your vehicle only at the designated lift points shown in the illustrations ⇒ [fig. 325](#) and ⇒ [fig. 326](#). Not using the designated lift points can cause the vehicle to fall off the floor jack when heavy parts such as the engine or transmission are removed.
- Always make sure that the vehicle's lift points lie as flat as possible and centered on the carrier plates of the floor jack.
- Never start the engine when you have raised the vehicle on the floor jack. The engine vibrations and vehicle movements could knock the vehicle off the floor jack.
- If you must work under a vehicle raised on a floor jack, always make sure that the vehicle is safely supported on safety stands intended for that purpose that are strong enough to support the weight of the vehicle.
- Never use the floor jack as a ladder or step ladder.
- Always make sure that the weight of the vehicle is not heavier than the lifting capacity of the floor jack and safety stands being used.



## NOTICE

- To help prevent serious vehicle damage, never lift the vehicle by the engine oil pan, transmission housing, or by the front or rear axles or suspension.
- To help prevent damage to the underbody or chassis, always insert a rubber pad between the hoist and the lifting points. In addition make sure the lifting arms have enough clearance.
- The lifting arms should not touch side sills or other parts of the vehicle.



## In an emergency

### Introduction

---

In this section you'll find information about:

Protecting yourself and the vehicle

#### More information:

- Braking and parking
- Emergency closing and opening
- Vehicle tool kit
- Changing a wheel

** WARNING**

A vehicle breakdown in traffic is dangerous and creates a great risk for you, your passengers, and others.

- Always stop the vehicle as soon as it is safe to do so and move the vehicle a safe distance off the road where it is safe to park and, if necessary lock all doors in an emergency. Turn on the emergency flasher and set up another warning device about 25 yards (25 meters) behind the vehicle to warn approaching traffic.
- Never leave children, disabled persons, or anyone who cannot help themselves alone in the vehicle when locking the doors. This could result in people being trapped in the vehicle in an emergency. Depending on the time of year, people trapped in the vehicle can be exposed to very high or very low temperatures.

### Protecting yourself and the vehicle

---



Fig. 327 In the center of the instrument panel: Switch for emergency flashers.



 Please first read and note the introductory information and heed the WARNINGS 

Obey all applicable legal requirements regarding protecting a broken-down vehicle. For example, turning on the emergency flashers and wearing a safety vest are mandatory in many countries.

## Checklist

---

For your own safety and that of your passengers, carry out the following steps in the order listed ⇒ .

1. Park the vehicle at safe distance from traffic and on a suitable surface ⇒ .
  2. Switch on emergency flashers by pressing the  switch ⇒ fig. 327.
  3. Apply the electronic parking brake to help prevent the vehicle from moving.
  4. Shift the transmission into Park (P)
  5. Stop the engine and remove the key from the ignition switch
  6. Have all passengers exit and go to a safe location away from moving traffic, such as behind a guard rail.
  7. Take all vehicle keys with you when leaving your vehicle.
  8. Set up a warning triangle or other warning device in order to alert other motorists and cyclists.
  9. Let the engine cool down and get expert assistance if necessary.
- 

If the emergency flashers are on, use the turn signal lever to indicate a direction or lane change, for example when the vehicle is being towed. This temporarily interrupts the emergency flashers.

### Switch on the emergency flashers when:

- Traffic suddenly slows down or stops in front of you to warn those approaching from behind.
- In any emergency situation.
- If the vehicle breaks down.
- When being towed.

Always obey traffic laws that govern the use of emergency flashers where you are driving.

If the emergency flashers are not working, a different method – as permitted by law – must be used to alert other motorists and cyclists to the breakdown.



### WARNING

Disregarding the safety-related checklist may lead to accidents and serious injuries.

- Always review and follow the checklist. Follow accepted safety practices and use common sense.



### WARNING

The vehicle exhaust system and the catalytic converter or diesel particulate filter get very hot and can cause a fire and serious personal injury.

- Never park where parts of the hot exhaust system or catalytic converter could ignite flammable materials, such as dry grass, brush, leaves, spilled fuel, etc.



The vehicle battery will be drained if the emergency flashers are on for a long time – even if the ignition is switched off.

# Emergency closing and opening

## Introduction

---

In this section you'll find information about:

- Manually unlocking and locking the driver door
- Manually locking the passenger doors
- Opening the rear hatch from inside the luggage compartment
- Emergency fuel filler flap release
- Emergency closing of the power sunroof
- Emergency release for the selector lever lock
- Emergency closing or opening

The doors and the rear hatch can be manually locked and, in some cases, unlocked if necessary, for instance because the power locking system or the remote control vehicle key malfunctions.

Emergency closing of the power sunroof is not possible with means in the vehicle. Contact an authorized Volkswagen dealer or authorized Volkswagen Service Facility for assistance.

### More information:

- Vehicle key set
- Power locking and closing system
- Doors
- Rear hatch
- Power sunroof
- In an emergency

### WARNING

Serious injuries can result if the emergency closing and opening procedures are used carelessly.

- Never leave children, disabled persons, or anyone who cannot help themselves in the vehicle. The doors can be locked with the remote control key. This could result in people being trapped in the vehicle in an emergency.
- A closed vehicle can become very hot or very cold, depending on the season. Particularly in the summer, heat buildup in the passenger and luggage compartment of a parked vehicle can result in temperatures in the vehicle that are much higher than the outside temperatures. Temperatures can quickly reach levels that can cause unconsciousness and death, particularly to small children.

### WARNING

Careless opening and closing of doors, the rear hatch, and the power sunroof is dangerous and can cause serious personal injury.

- Open or close doors, rear hatch, and power sunroof only when no one is in the way.

**NOTICE**

To help prevent vehicle damage, carefully remove and properly reinstall parts after emergency locking or unlocking.

## Manually unlocking and locking the driver door

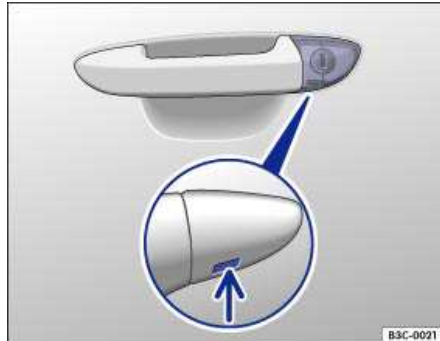

Fig. 328 Door handle on driver door: Concealed lock cylinder.

**⚠ Please first read and note the introductory information and heed the WARNINGS ⚠**

When locking the vehicle manually all doors are locked. When the vehicle is unlocked manually, only the driver door is unlocked. Note the instructions for the anti-theft alarm system ⇒ *Power locking and closing system*.

- Take the emergency key out of the remote control vehicle key ⇒ *Vehicle key set*.
- Insert the emergency key from below into the opening of the cover cap on the driver door ⇒ fig. 328 (arrow) and lift the cover cap off. Grasping the door handle and pulling slightly makes it easier to remove the cap.
- Insert the emergency key into the lock cylinder and unlock or lock the door.
- Reinsert the cover cap from top to bottom and press until it clicks into place. Grasping the door handle and pulling slightly makes it easier to install the cap.

**Special considerations when unlocking:**

- If the vehicle is equipped with an The anti-theft alarm system, the system remains activated for the unlocked vehicle. But no alarm is triggered at first ⇒ *Power locking and closing system*.
- Open the driver door; the alarm will sound if the ignition is not switched on within about 15 seconds.
- Switch on the ignition. The electronic immobilizer recognizes a valid remote control vehicle key when the ignition is switched on and deactivates the anti-theft alarm system.

**i** The driver door can be unlocked separately from the inside the vehicle by pulling the door handle to open the door ⇒ *Power locking and closing system*.

**i** The anti-theft alarm system is not activated when the vehicle is locked with the emergency key ⇒ *Power locking and closing system*.

## Manually locking the passenger doors

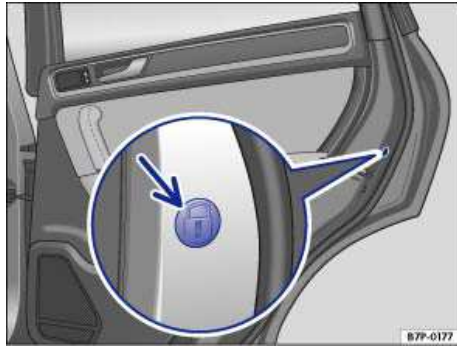



Fig. 329 On the front side of the right rear door: Emergency lock, covered by a rubber seal.



Fig. 330 Locking the vehicle using the emergency key.

### **⚠ Please first read and note the introductory information and heed the WARNINGS**

The passenger door and rear doors can each be locked manually. This will **not** activate the anti-theft alarm system.

- Open the door.
- Remove the rubber seal on the front side of the door. The seal is marked with a lock  ⇒ fig. 329.
- Take the emergency key out of the remote control vehicle key ⇒ *Vehicle key set*.
- Insert the emergency key into the vertical slit and turn the key away from the vehicle ⇒ fig. 330.
- Re-insert the rubber seal and completely close the door.
- Make sure that the door is locked.
- Repeat the procedure for other doors if necessary.
- Have the vehicle checked immediately by an authorized Volkswagen dealer or an authorized Volkswagen Service Facility.

 Doors can be unlocked separately from the inside the vehicle by pulling the door handle once. If necessary, pull the door handle again ⇒ *Power locking and closing system*.

## Opening the rear hatch from inside the luggage compartment

---

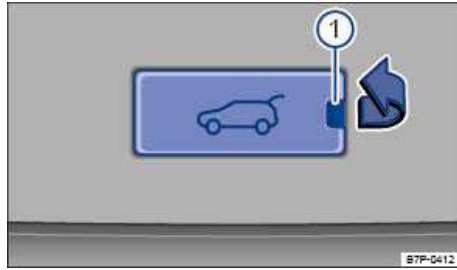

Fig. 331 Inside the luggage compartment: Remove the cover plate in the rear hatch.

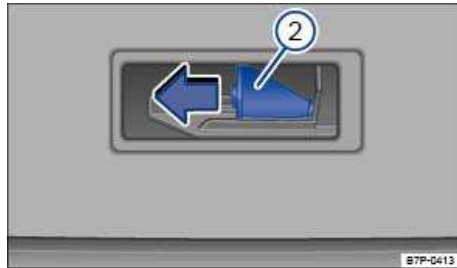

Fig. 332 Inside the luggage compartment: Release lever in the rear hatch.

ⓘ Please first read and note the introductory information and heed the WARNINGS ⚠

- If necessary, fold the rear seat bench backrest forward ⇒ *Seat functions*.
- Remove luggage in order to reach the rear hatch from the inside.
- Remove the rectangular cover in the inside trim of the rear hatch by inserting a small screwdriver in the opening ⇒ fig. 331 (1).
- Use a small screwdriver to unlock the rear hatch, by push the release lever in direction of the arrow ⇒ fig. 332 (2).
- Open the rear hatch, using more force than usual.

## Emergency fuel filler flap release

---

ⓘ Please first read and note the introductory information and heed the WARNINGS ⚠

There is no emergency release for the fuel filler flap. Contact an authorized Volkswagen dealer or an authorized Volkswagen Service Facility for assistance.

## Emergency closing of the power sunroof

---

ⓘ Please first read and note the introductory information and heed the WARNINGS ⚠

If your power sunroof will not close properly, do not try to close it yourself, doing so can cause serious and expensive damage that will not be covered by any Volkswagen Limited Warranty. Special

knowledge and tools are required to close the power sunroof if it will not close on its own. To help prevent damage to the sunroof, have an authorized Volkswagen dealer or an authorized Volkswagen Service Facility help you close and repair the power sunroof.

## Emergency release for the selector lever lock

⚠ Please first read and note the introductory information and heed the WARNINGS ⚠

If the vehicle battery is dead or the power supply fails for another reason and you want to have the vehicle towed, the gearshift selector lever must first be released with the emergency procedure. Get professional assistance.

### ⚠ WARNING

Never shift the transmission out of Park (P) unless the electronic parking brake is engaged. Otherwise, the vehicle can start to roll unexpectedly, especially on hills or inclines, and cause an accident and serious personal injury.

### ! NOTICE

Even with the selector lever is in Neutral (N), the automatic transmission will be damaged iff the vehicle is towed (or you let it coast) for an extended period or at high speed with the engine shut off.

## Emergency closing or opening

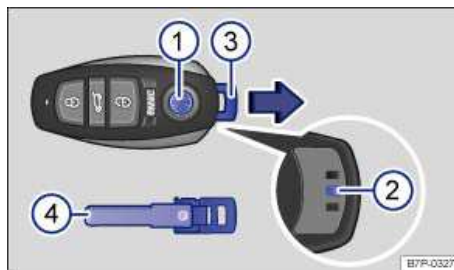

Fig. 333 Releasing and removing the emergency key from the remote control vehicle key with alarm button.

⚠ Please first read and note the introductory information and heed the WARNINGS ⚠

If you can't get the vehicle key out of the ignition because the vehicle battery is dead or for some other reason, follow these steps:

- Press and hold the button ⇒ fig. 333 (1) with one hand.
- Press the locking tab (2) on the bottom of the emergency key (4) with the other hand while pulling the emergency key out in the direction indicated by the arrow.

Lock the vehicle manually and contact an authorized Volkswagen dealer or an Authorized Volkswagen Service Facility for assistance.

Please see the vehicle key set section in your Owner's Manual for further instruction if needed.

# Vehicle tool kit

## Introduction

---

In this section you'll find information about:

- Storage
- Contents
- Folding chocks

When securing the vehicle after a breakdown, always obey all applicable legal requirements.

### More information:

- Working in the engine compartment
- In an emergency
- Changing a wheel
- Tire mobility set



### WARNING

Loose tools and other items in the vehicle tool kit and tire mobility kit and a loose collapsible spare tire may be thrown through the passenger compartment if you brake suddenly or steer sharply or are involved in an accident. This can cause severe injuries.

- Always make sure the vehicle tool kit, tire mobility kit, and collapsible spare tire are securely stowed in the luggage compartment.



### WARNING

Improper or damaged vehicle tools can lead to accidents and injury.

- Never work with tool that are damaged or not right for the job.

## Storage

---

 Please first read and note the introductory information and heed the WARNINGS 

The vehicle tool kit, the collapsible spare tire, and the tire mobility set with folding chocks are stowed under the luggage compartment floor panel.

The tire mobility set is in the foam organizer insert on the right side together with the vehicle tool kit.

- Lift up the luggage compartment floor panel and hook it to the top of the luggage compartment or remove the reversible luggage compartment floor panel ⇒ page 149, *Luggage compartment*.
- Undo the retaining strap to take out the vehicle tool kit.



Completely retract the jack after use. Otherwise it will not fit in its compartment and cannot be stowed safely.



## Contents

---

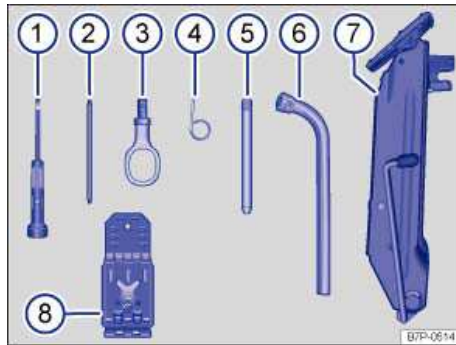

Fig. 334 Contents of the vehicle tool kit.

**⚠ Please first read and note the introductory information and heed the WARNINGS ⚠**

The contents of the vehicle tool kit depend on the vehicle configuration. The following describes the maximum contents.

**Contents of the vehicle tool kit** ⇒ fig. 334:

- (1) Screwdriver with removable blade.
- (2) Torx bit. The Torx bit is removable and can be inserted in the screwdriver handle instead of the screwdriver blade.
- (3) Screw-in towing eyes.
- (4) Hubcap puller clips for removing wheel bolt caps.
- (5) Pin for changing a wheel.
- (6) Lug wrench.
- (7) Jack. Prior to storing the jack in the tool box, make sure to completely crank the jack down to its original position. Next the crank lever must be braced against the side of the jack.
- (8) Folding chocks ⇒ *Folding chocks*.

## Folding chocks

---

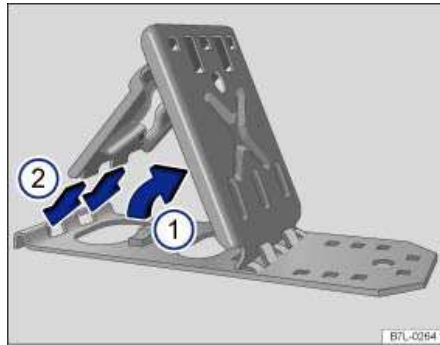

Fig. 335 Setting up folding chock.

 **Please first read and note the introductory information and heed the WARNINGS**

The folding chocks are with the vehicle tool kit.

#### **Setting up folding chocks**

- Raise the support plate ⇒ [fig. 335 \(1\)](#).
- Insert both “lugs” of the securing plate completely in the elongated holes of the base plate [\(2\)](#).

#### **Proper use**

The folding chock can be used to block the wheel diagonal to the wheel which is to be changed.

The folding chock must be placed directly in front of and behind the wheel and may be used only on firm surfaces.



#### **WARNING**

**Improper setup or improper use of the folding chocks can cause accidents and injuries.**

- **Never use damaged folding chocks.**
- **Never use folding chocks to secure the vehicle on slopes.**

## Wheel trim

### Introduction

---

In this section you'll find information about:

Wheel bolt caps

**More information:**

- Exterior care and cleaning
- Vehicle tool kit
- Changing a wheel
- Tire mobility set

#### **WARNING**

**Unsuitable wheel covers and improper installation of wheel covers can cause accidents and severe injuries.**

- **Improperly installed wheel covers can come loose while driving and endanger other motorists and cyclists.**
- **Do not use damaged wheel covers.**
- **Always make sure that the flow of air for brake system cooling is not blocked or reduced before installing wheel covers. This applies to both factory installed wheel covers and after-market wheel covers. Insufficient air supply may significantly increase stopping distance.**

#### **NOTICE**

To help prevent damage to the vehicle, be careful when removing wheel covers and be sure to install them properly.

## Wheel bolt caps

---



**Fig. 336** Pulling cover caps off wheel bolts.

**⚠ Please first read and note the introductory information and heed the WARNINGS ⚠**

- Take the wire clip out of the vehicle tool kit ⇒ page 647, *Vehicle tool kit*.
- Insert the wire clip through the opening of the cover cap ⇒ [fig. 336](#) and pull off in the direction of the arrow.

The caps are designed to protect the wheel bolts and should be installed again after the wheel change.

# Tire mobility set

## Introduction

---

In this section you'll find information about:

Contents of the tire mobility set

Preparations

Sealing and inflating the tire

Check after 10 minutes of driving

Tire damage caused by foreign objects or punctures up to about **3/16 in (4 mm)** in diameter can be reliably sealed using the tire mobility set. **The foreign object (screw or nail, for example) must not be removed from the tire!**

After the sealant is filled into the tire, drive for about 10 minutes and check tire pressure again.

Never use the tire mobility set to fill a tire unless you

- have parked vehicle at a safe spot,
- are familiar with all the necessary procedures and safety precautions, and
- have the correct tire mobility yet.

Otherwise, get expert assistance.

### **Tire sealant must not be used:**

- If the wheel rim is damaged.
- At outside temperatures below -4 °F (20 °C).
- If the cut or puncture damage of the tire is greater than 3/16 in (4 mm) in diameter.
- If you were driving with very low tire pressure or a flat tire.
- If the tire inflation cylinder has passed its expiration date.

### **More information:**

- Remote control vehicle key set
- Tires and wheels
- Braking and parking
- In an emergency
- Wheel covers

 **WARNING**

Using the tire mobility set on the side of the road can be dangerous. To help reduce the risk of serious personal injury:

- Always stop the vehicle as soon as it is safe to do so and move the vehicle a safe distance off the road where it is safe to use the tire mobility set.
- Make sure that the ground is level and firm.
- All passengers and especially children must stay a safe distance away from you while you are working and keep out of the area you are working in.
- Turn on the emergency flasher and set up another warning device about 25 yards (25 meters) behind the vehicle to warn approaching traffic.
- Use the tire mobility set only if you are familiar with the necessary steps. Otherwise, get expert assistance.
- Use the tire mobility set only in emergencies and only until you can get professional help.
- Immediately replace a tire repaired with the tire mobility set.
- Sealant is harmful and must immediately be removed in case of skin contact.
- Always store the tire mobility set out of reach of children.
- Never use a vehicle jack, even if the jack is approved for use with your vehicle.
- Always switch off the engine, engage the electronic parking brake, and shift the transmission into Park (P) to reduce the risk that the vehicle will move unexpectedly.

 **WARNING**

Improper use of the tire mobility set can cause a temporary tire to fail and lead to loss of vehicle control and serious personal injuries.

- Always remember that a tire filled with sealant does not handle as well as an undamaged tire without sealant.
- Never drive faster than 50 mph (80 km/h) with a sealed tire.
- Never use the tire mobility set if the outside temperature is below  $-4^{\circ}\text{F}$  ( $-20^{\circ}\text{C}$ ).
- Never drive with a tire that has cuts or punctures, especially when they are larger than  $3/16$  in (4 mm).
- Use the tire mobility set only for emergencies until you can get professional help.
- If the tire cannot be inflated to at least 36 psi (2.5 bar), do not drive the vehicle. Contact the nearest authorized Volkswagen dealer, authorized Volkswagen Service Facility, or other qualified workshop.
- If the tire inflation pressure drops below 26 psi (1.8 bar) after driving for 10 minutes, do not drive the vehicle any farther. Contact the nearest authorized Volkswagen dealer, authorized Volkswagen Service Facility, or other qualified workshop.
- Always replace a tire repaired with the tire mobility set immediately. Do not drive a tire that has been repaired with the tire mobility set longer or farther than is absolutely necessary.
- Avoid full throttle acceleration, hard, braking, and fast cornering.
- Drive at slow speed for 10 minutes. Then get out and check the air pressure and condition of the sealed tire.



Obey all legal requirements when disposing of used or expired sealant.



New tire inflation cylinders are available from authorized Volkswagen dealers and authorized Volkswagen Service Facilities.

 Read the separate user manual of the manufacturer of the tire mobility set.

## Contents of the tire mobility set

---

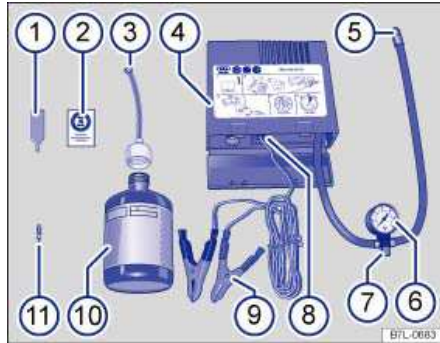

Fig. 343 Basic diagram: Contents of the tire mobility set.

 Please first read and note the introductory information and heed the WARNINGS 

The tire mobility set is stored in the luggage compartment under the floor panel. It contains the following ⇒ fig. 343:

- (1) Valve core wrench
- (2) Label with speed instruction “max. 80 km/h” or “max. 50 mph”
- (3) Filling hose with sealing plug
- (4) Air compressor
- (5) Tire inflation hose
- (6) Tire pressure gauge<sup>42</sup>
- (7) Air release valve<sup>43</sup>
- (8) ON and OFF switch
- (9) 12 Volt clips
- (10) Tire inflation bottle with sealant
- (11) Replacement valve core

The **valve core wrench** (1) has a slit on the lower end which fits the valve core. This is the only way to unscrew the valve core from the tire valve and to screw it in again. This also applies for the replacement valve core (11).

## Preparations

---

 Please first read and note the introductory information and heed the WARNINGS 

<sup>42</sup> May also be integrated in the compressor.

<sup>43</sup> Instead of this, a button may be included in the compressor.

## Checklist

Carry out the following steps in the order listed before starting to inflate a tire ⇒ ⚠:

1. If you have a flat tire, move it as far away from traffic as possible. Park the vehicle on a flat, level surface at a safe spot.
2. Apply the electronic parking brake
3. Automatic transmission: Shift the transmission into Park (**P**).
4. Stop the engine and remove the key from the ignition switch
5. Have all passengers exit and go to a safe place, such as behind the guard rail.
6. Switch on emergency flashers and put up the warning triangle. Observe all legal requirements.
7. Check whether a repair with the tire mobility set is possible
8. If towing a trailer: Unhitch the trailer from the vehicle and park the trailer properly.
9. If the luggage compartment is loaded: Remove the luggage.
10. Remove the tire mobility set from the luggage compartment.
11. Affix the label ⇒ [fig. 343 \(2\)](#) from the tire mobility set on the dashboard in the driver's field of vision.
12. The foreign object (screw or nail, for example) should **not** be removed from the tire!

### ⚠ WARNING

Disregarding the safety-related checklist may lead to accidents and serious injuries.

- Always review and follow the checklist. Follow accepted safety practices and use common sense.

## Sealing and inflating the tire

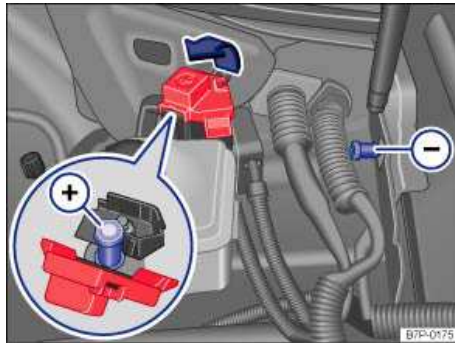

[Fig. 344](#) In the engine compartment: Compressor connection terminals.

⚠ Please first read and note the introductory information and heed the WARNINGS ⚠



### Sealing the tire

- Unscrew the valve cap from the tire valve.
- Unscrew the valve core from the tire valve using the valve core wrench ⇒ [fig. 343 \(1\)](#) and place it on a clean surface.



- Vigorously shake the tire inflation cylinder ⇒ [fig. 343 \(10\)](#) a few times back and forth.
- Tightly screw the filling hose ⇒ [fig. 343 \(3\)](#) to the tire inflation bottle (turn clockwise). The foil on the seal is automatically pierced.
- Remove the sealing plug from the filling hose ⇒ [fig. 343 \(3\)](#) and slide the open end onto the tire valve.
- Hold the cylinder with the bottom pointing up and fill the **entire** contents of the tire inflation cylinder into the tire.
- Detach the empty tire inflation cylinder from the valve.
- Using the valve core wrench ⇒ [fig. 343 \(1\)](#) screw the valve core back into the tire valve.

### Inflating the tire

- Screw the tire inflation hose ⇒ [fig. 343 \(5\)](#) of the air compressor tightly to the tire valve.
- Check whether the air release valve ⇒ [fig. 343 \(7\)](#) is screwed on tightly.
- Open the engine hood ⇒ *Working in the engine compartment*.
- Attach the cable clips ⇒ [fig. 343 \(9\)](#) **only** to the jump-start terminals in the engine compartment ⇒ [fig. 344](#). The red clip on the compressor cable is connected to the positive (+) terminal; the black clip is connected to the negative terminal (–).
- Start the vehicle engine and let it run.
- Switch the air compressor on using the ON / OFF switch ⇒ [fig. 343 \(8\)](#),
- Let the air compressor run until a pressure of 36 – 44 psi (250 - 300 kPa) is reached ⇒  **Maximum run time 8 minutes** ⇒ .
- Switch off the air compressor.
- If an air pressure of 36 – 44 psi (250 - 300 kPa) **cannot be reached**, unscrew the tire inflation hose from the tire valve.
- Drive about 30 feet (10 meters) backwards or forwards so that the sealant can be distributed inside the tire.
- Connect the tire inflation hose of the air compressor again to the tire valve and repeat the inflation process.
- If the required tire pressure still cannot be reached, the tire is too badly damaged. The tire cannot be sealed using the tire mobility set. Do not drive the vehicle. Get professional assistance ⇒ .
- Disconnect the air compressor and unscrew the tire inflation hose from the tire valve.
- If a tire pressure of 36 – 44 psi (250 – 300 kPa) is reached, continue driving right away and drive at a speed of not more than 50 mph (80 km/h).
- Check tire pressure after **10 minutes** of driving ⇒ *Check after 10 minutes of driving*.

### **WARNING**

**The tire inflation hose and air compressor can get hot during inflation.**

- **Protect hands and skin from hot parts.**
- **Do not place the hot tire inflation hose or hot air compressor on flammable material.**
- **Let the equipment cool off almost completely before stowing it.**
- **If the tire cannot be inflated to at least 36 psi (250 kPa), the damage is too great to be repaired with the tire mobility set. The sealant is not able to seal the tire. Do not drive the vehicle. Get professional assistance.**

 **NOTICE**

Do not let the compressor run for more than 8 minutes to help prevent overheating and damage. Let the compressor cool down for a few minutes before switching it on again. Let it cool down almost completely before stowing it in the repair kit.

### Check after 10 minutes of driving

---

 Please first read and note the introductory information and heed the WARNINGS 

Connect the tire inflation hose ⇒ [fig. 343 \(5\)](#) again and read the tire pressure on the tire pressure gauge (6).

**26 psi (180 kPa) and less:**

- **Stop!** The tire cannot be sealed sufficiently using the tire mobility set.
- Get professional assistance ⇒ .

**27 psi (190 kPa) and more:**

- Correct the tire pressure again to the proper value ⇒ *Tires and wheels*.
- Carefully drive on to the next service center at a speed of not more than 50 mph (80 km/h).
- Have the damaged tire replaced.

 **WARNING**

Driving with a tire that cannot be sealed is dangerous and can cause accidents and severe injuries.

- Do not continue driving if the tire pressure is 26 psi (180 kPa) or less.
- Get professional assistance.

# Changing a wheel

## Introduction

---

In this section you'll find information about:

Preparations for changing a wheel

Wheel bolts

Lifting the vehicle with the vehicle jack

Lifting the vehicle with the vehicle jack (R Line)

Changing a wheel

After changing a wheel

Some vehicle designs and models are not delivered with a jack and lug wrench. In such cases, Volkswagen recommends having tires and wheels changed by an authorized Volkswagen dealer or an authorized Volkswagen Service Facility.

Change a wheel by yourself only if the vehicle is parked in a safe location, you are familiar with safety procedures and the technical steps, and you have proper tools available. Otherwise, get expert assistance.

The vehicle jack can only be safely used to change the wheel on a vehicle that has only one flat or damaged tire. The vehicle will not have the support it needs from 3 fully inflated tires. The vehicle can fall off the jack. If more than one tire on the vehicle is flat or damaged, do not lift the vehicle with the vehicle jack. Instead, get expert assistance.

### **More information:**

- Exterior views
- Vehicle key set
- Tires and wheels
- In an emergency
- Vehicle tool kit
- Wheel covers



## WARNING

Changing a wheel, especially on the side of the road, can be dangerous. To help reduce the risk of serious personal injury:

- Always stop the vehicle as soon as it is safe to do so. Move the vehicle a safe distance off the road where it is safe to change the wheel.
- Always make sure that all passengers, especially children, are in a safe place outside the vehicle and away from the vehicle and traffic (such as behind a guard rail).
- Turn on the emergency flasher and set up another warning device about 25 yards (25 meters) behind the vehicle to warn approaching traffic.
- Change a wheel by yourself only if you are familiar with the necessary steps. Otherwise, get expert assistance.
- Always switch the engine off, firmly apply the parking brake, and shift the transmission into Park (P) (automatic transmission) or any gear (manual only) to help prevent the vehicle from moving suddenly and slipping off the jack.
- Always make sure that the ground is level and firm. If necessary, place the jack or a large and sturdy board or on a similar ground support.
- Always block the wheel diagonally opposite the wheel being changed with chocks or similar things.
- If you are towing a trailer, always unhitch it from your vehicle before starting to change the wheel. Always apply the trailer brakes firmly and make sure the trailer cannot move unintentionally.
- Always use proper and undamaged tools when changing a tire.
- Once a wheel is lifted off the ground, having the transmission in Park (P) or in gear will not prevent sudden vehicle movement.
- Always use a jack that has been approved by the manufacturer for your vehicle. Never use other jacks, even if they have been approved for use on other Volkswagen models.
- To reduce the risk of losing control, crashes, and serious personal injuries, never loosen the screws on rims with threaded rim rings.
- After changing a wheel, have the wheel bolt tightening torque checked with an accurate torque wrench.

## Preparations for changing a wheel

 Please first read and note the introductory information and heed the WARNINGS 

### Checklist

Getting ready to change a wheel. Follow these steps in the order listed here ⇒ :

1. If you have a flat tire, move as far away from traffic as possible. Park the vehicle on a flat, level surface where no part of the hot catalytic converter and exhaust system can come into contact with flammable materials under the vehicle, such as dry grass, brush, spilled fuel, etc.
2. Apply the electronic parking brake to help prevent the vehicle from moving ⇒ *Braking and parking*.
3. Shift the transmission into Park (P) ⇒ *Shifting*.
4. Stop the engine and remove the key from the ignition switch ⇒ *Starting and stopping the engine*.
5. Have all passengers exit and go to a safe place, such as behind a guard rail.
6. Block the diagonally opposite wheel with chocks or other suitable things.
7. If towing a trailer: Unhitch the trailer from the vehicle and park the trailer properly.

8. If the luggage compartment is loaded: Remove the luggage.
9. Take the collapsible spare tire and the vehicle tool kit out of the luggage compartment.
10. Take off the wheel bolt caps ⇒ *Wheel trim*.

## **⚠ WARNING**

Disregarding the safety-related checklist may lead to accidents and serious personal injuries.

- Always review and follow the checklist. Follow accepted safety practices and use common sense.

## Wheel bolts



Fig. 337 Changing a wheel: Loosening wheel bolts.

**⚠ Please first read and note the introductory information and heed the WARNINGS ⚠**

Loosen the wheel bolts only with the lug wrench that was supplied with the vehicle.

Loosen the wheel bolts only about 1 turn before lifting the vehicle with the jack.

If a wheel bolt does not come loose, carefully push the end of the lug wrench with your foot. Make sure you are standing firmly on the ground and hold on to the vehicle for support.

### Loosening the wheel bolts

- Push the lug wrench over the wheel bolt all the way ⇒ fig. 337.
- Holding the lug wrench at the end, loosen the wheel bolt by turning it counterclockwise about 1 complete turn (360°) ⇒ ⚠.

### Important information regarding wheel bolts

The design of rims and wheel bolts is matched to the factory-installed wheels. If different wheels are installed, wheel bolts with the right length and bolt head shape must be used. The attachment of the wheels and function of the brake system depend on this.

It may not be possible to use wheel bolts from different vehicles of the same model.

### Wheel bolt tightening torque

Correctly tightened bolts for steel and alloy wheel rims should have a torque of **133 ft-lbs. (180 Nm)**. After changing a wheel, have the wheel bolt tightening torque checked right away with an accurate torque wrench.

**Before you check** the tightening torque, replace corroded and difficult-to-turn wheel bolts and clean the threads in the wheel hub.

Never grease or oil the wheel bolts and the threads in the wheel hubs. The bolts can come loose while driving if greased or oiled, even if tightened to the required torque.



#### WARNING

Improperly tightened wheel bolts can come loose while driving and cause you to lose control over the vehicle, resulting in accidents and serious injuries.

- Only use wheel bolts that belong your vehicle and to the wheel being installed.
- Never use different wheel bolts.
- Wheel bolts and wheel hub threads must always be clean, easy-to-turn and free of oil and grease.
- Only use the lug wrench that is supplied with the vehicle to loosen the wheel bolts.
- Loosen the wheel bolts only about one turn before lifting the vehicle with the jack.
- Never grease or oil the wheel bolts and the threads in the wheel hubs. The bolts can come loose while driving if greased or oiled, even if tightened to the required torque.
- Never loosen bolted connections on wheel rims with bolted rim rings.
- If the wheel bolts are not tightened to the proper torque, the wheel can come off the vehicle when it is moving. Extremely high torque can damage the wheel bolts and/or their threads.

### Lifting the vehicle with the vehicle jack

---

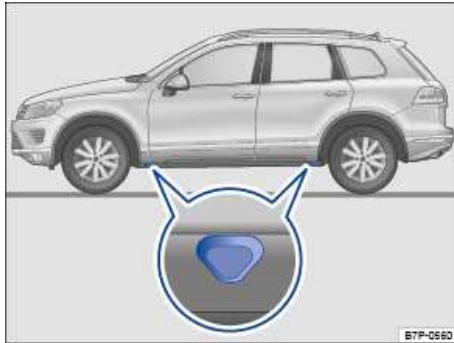
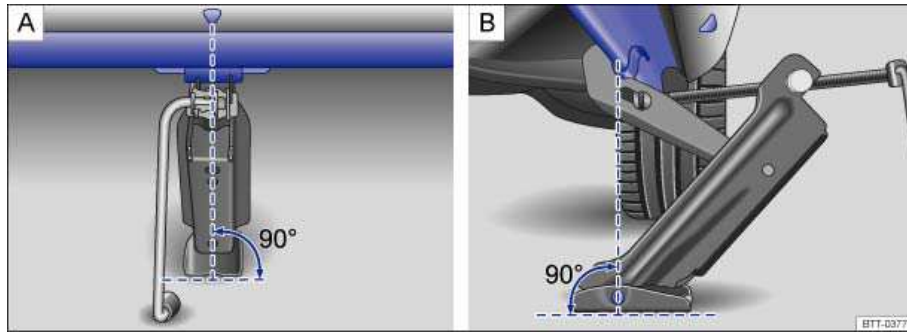

Fig. 338 Lift points for the jack.



**Fig. 339** Jack in position at the left rear lift point.

**⚠ Please first read and note the introductory information and heed the WARNINGS ⚠**

The standard vehicle jack cannot be safely used to raise the vehicle when the side steps, extended door sills or similar enhancements have been installed in the area of the lower side sills ⇒ ⚠.

The jack must be positioned at one of the 4 lift points marked on the vehicle body (2 on each side as shown in ⇒ [fig. 338](#)). You must use the lift point closest to the wheel being changed ⇒ ⚠.

The vehicle may only be lifted by a jack positioned at 1 of the 4 jack lift points.

Do not jack up the vehicle until all the wheel bolts on the wheel being changed have been loosened

### Checklist

For your own safety and that of your passengers, carry out the following steps in the order listed ⇒ ⚠:

1. Find a level spot on firm ground for lifting the vehicle.
2. Switch off the engine, shift the transmission into Park (**P**) ⇒ *Shifting*. Then apply the parking brake to help prevent the vehicle from moving ⇒ *Braking and parking*.
3. If towing a trailer: Unhitch the trailer from the vehicle and park the trailer properly.
4. Straighten the steering wheel so that the front wheels point straight forward.
5. Block the diagonally opposite wheel with chocks or other suitable things.
6. Loosen the wheel bolts of the wheel to be changed ⇒ *Wheel bolts*.
7. Find the jack lift point ⇒ [fig. 338](#) on the vehicle frame that is closest to the wheel to be changed.
8. Crank up the jack so that it still just fits underneath the lift point.
9. Position the jack so that its base is directly underneath the lift point ⇒ [fig. 339](#), making sure that the entire base of the jack rests securely on the ground.
10. Align the jack and wind up the jack claw at the same time, until the claw cradles the vertical rib underneath the vehicle ⇒ [fig. 339 A / B](#).
11. Continue cranking up the jack until the wheel is just a little off the ground.



### WARNING

Using the wrong jack to raise a vehicle with side steps, extended door sills, additional decorative trim or other enhancements in the area of the lower side sills can cause the vehicle to fall off the jack and result in serious personal injury.

- Never use the standard jack supplied with unmodified vehicles to raise the vehicle. The side step can interfere with the jack when raising the vehicle.
- Always use the scissor vehicle jack supplied with the authorized side step package when the vehicle must be jacked up, for example, to change a tire.



### WARNING

Improper use of your vehicle jack can cause the vehicle to fall off the jack leading to serious personal injury. To help reduce the risk of serious personal injury:

- Use only jacks approved by Volkswagen for the vehicle. Other jacks might slip, even those approved for other Volkswagen models, but not for your vehicle.
- Always set up the jack on firm and level ground. The vehicle may slip off the jack if the jack is resting on soft or sloping ground. If necessary, place a sturdy board under the jack.
- On a hard, slippery surface (such as a tiled floor), use an anti-skid rubber mat or something similar to prevent the jack from slipping.
- Position the jack only at the described vehicle lift points. Before you raise your vehicle, always make sure the jack claw properly grips the rib under the sill so that the jack does not slip off when you are raising the vehicle ⇒ [fig. 339](#).
- Never have any part of your body (such as your arm or leg) under the vehicle when it is supported by the jack. Never let other persons have any part of their body under the vehicle, either!
- If you must work under a vehicle raised on a floor jack, always make sure that the vehicle is safely supported on safety stands intended for that purpose that are strong enough to support the weight of the vehicle.
- Never lift the vehicle when it is tilted or inclined to one side or the engine is running.
- Never lift the vehicle when more than one tire is flat or damaged.
- Do not start the engine while the vehicle is supported by a jack. Engine vibrations may cause the vehicle to slip off the jack.



### WARNING

Disregarding the safety-related checklist may lead to accidents and serious injuries.

- Always review and follow the checklist. Follow accepted safety practices and use common sense.



## Lifting the vehicle with the vehicle jack (R Line)

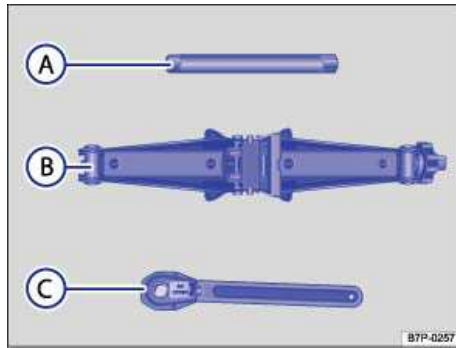

Fig. 340 Scissor jack components.

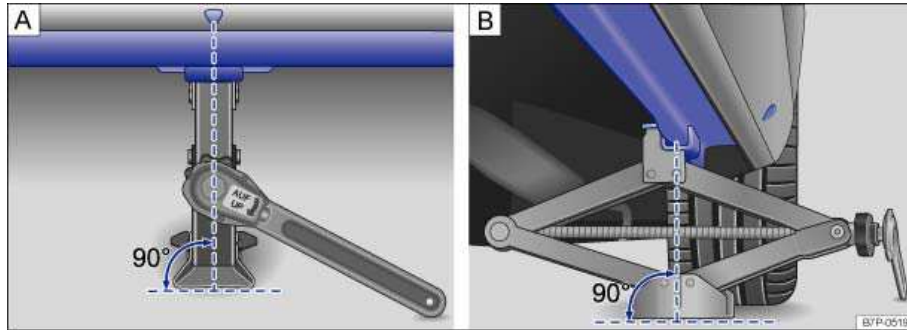

Fig. 341 Jack in position at the left rear lift point.

**⚠ Please first read and note the introductory information and heed the WARNINGS ⚠**

The standard vehicle jack cannot be safely used to raise the vehicle when the side steps, extended door sills or similar enhancements have been installed in the area of the lower side sills

Use only the scissor jack if your vehicle has side steps, extended door sills additional decorative trim or other enhancements in the area of the lower side sill. Raise the vehicle only at the appropriate jack points for the vehicle jack.

Always use the scissor vehicle jack supplied with the authorized side step package when the vehicle must be jacked up, for example, to change a tire. This scissor jack is also available for purchase from authorized Volkswagen dealers if your vehicle is equipped with authorized accessory side steps.

The jack must be positioned at one of the 4 lift points marked on the vehicle body (2 on each side as shown in ⇒ fig. 338). You must use the lift point closest to the wheel being changed ⇒ ⚠.

Do not jack up the vehicle until all the wheel bolts on the wheel being changed have been loosened ⇒ *Wheel bolts*.

### Checklist

For your own safety and that of your passengers, carry out the following steps in the order listed ⇒ ⚠:

1. Find a level spot on firm ground for lifting the vehicle.

2. Switch off the engine, shift the transmission into Park **(P)** ⇒ *Shifting*. Then apply the parking brake to help prevent the vehicle from moving ⇒ *Braking and parking*.
  3. If towing a trailer: Unhitch the trailer from the vehicle and park the trailer properly.
  4. Straighten the steering wheel so that the front wheels point straight forward.
  5. Block the diagonally opposite wheel with chocks or other suitable things.
  6. Loosen the wheel bolts of the wheel to be changed ⇒ *Wheel bolts*.
  7. Remove the scissors jack and tools from the vehicle.
  8. Inset the extension ⇒ [fig. 340 \(A\)](#) into the scissors jack **(B)** Attach the crank **(C)** to the extension **(A)**.
  9. Find the jack lift point ⇒ [fig. 340](#) on the vehicle frame that is closest to the wheel to be changed.
  10. Crank up the jack so that it still just fits underneath the lift point.
  11. Position the jack so that its base is directly underneath the lift point ⇒ [fig. 341](#), making sure that the entire base of the jack rests securely on the ground.
  12. Align the jack and wind up the jack claw at the same time, until the claw cradles the rib underneath the vehicle ⇒ [fig. 341 A or B](#).
  13. Continue cranking up the jack until the wheel is just a little off the ground.
- 



#### **WARNING**

Using the wrong jack to raise a vehicle with side steps, extended door sills, additional decorative trim or other enhancements in the area of the lower side sills can cause the vehicle to fall off the jack and result in serious personal injury.

- Never use the standard jack supplied with unmodified vehicles to raise the vehicle. The side step can interfere with the jack when raising the vehicle.
- Always use the scissor vehicle jack supplied with the authorized side step package when the vehicle must be jacked up, for example, to change a tire.

## **⚠ WARNING**

Improper use of your vehicle jack can cause the vehicle to fall off the jack leading to serious personal injury. To help reduce the risk of serious personal injury:

- Use only jacks approved by Volkswagen for the vehicle. Other jacks might slip, even those approved for other Volkswagen models, but not for your vehicle.
- Always set up the jack on firm and level ground. The vehicle may slip off the jack if the jack is resting on soft or sloping ground. If necessary, place a sturdy board under the jack.
- On a hard, slippery surface (such as a tiled floor), use an anti-skid rubber mat or something similar to prevent the jack from slipping.
- Position the jack only at the described vehicle lift points. Before you raise your vehicle, always make sure the jack claw properly grips the rib under the sill so that the jack does not slip off when you are raising the vehicle ⇒ [fig. 341](#).
- Never have any part of your body (such as your arm or leg) under the vehicle when it is supported by the jack. Never let other persons have any part of their body under the vehicle, either!
- If you must work under a vehicle raised on a floor jack, always make sure that the vehicle is safely supported on safety stands intended for that purpose that are strong enough to support the weight of the vehicle.
- Never lift the vehicle when it is tilted or inclined to one side or the engine is running.
- Never lift the vehicle when more than one tire is flat or damaged.
- Do not start the engine while the vehicle is supported by a jack. Engine vibrations may cause the vehicle to slip off the jack.

## **⚠ WARNING**

Disregarding the safety-related checklist may lead to accidents and serious injuries.

- Always review and follow the checklist. Follow accepted safety practices and use common sense.

## Changing a wheel

---



[Fig. 342](#) Changing a wheel: Mounting pin in wheel bolt hole closest to the top.

Please first read and note the introductory information and heed the WARNINGS **⚠**

## Removing the wheel

- Review the checklist ⇒ *Preparations for changing a wheel*.
- Loosen the wheel bolts ⇒ *Wheel bolts*.
- Lift the vehicle ⇒ *Lifting the vehicle with the vehicle jack*.
- Unscrew the topmost loosened wheel bolt using the hexagonal socket in the screwdriver handle ⇒ [fig. 334](#) place it on a clean surface.
- Screw the mounting pin in the vehicle tool kit into the empty hole by hand ⇒ [fig. 342](#).
- Remove the remaining wheel bolts using the hexagonal socket in the screwdriver handle ⇒ [fig. 334](#) and place them on a clean surface.
- Remove the wheel.

## Mounting spare tire or collapsible spare tire

If the tire is a unidirectional tire, be sure to install it in the proper rolling direction ⇒ *Unidirectional tires*.

- Put the spare tire or collapsible spare tire into place on the vehicle.
- Screw in 4 wheel bolts clockwise and tighten them *slightly* using the hexagonal socket in the screwdriver handle.
- Unscrew the mounting pin and screw in the last wheel bolt.
- Lower the vehicle with the jack.
- Use the lug wrench to firmly tighten all wheel bolts (turn clockwise) ⇒ . Do not tighten them in sequence! Tighten any wheel bolt to begin, then tighten the wheel bolt diagonally opposite the first bolt, and so forth.
- Install the wheel bolt caps, center wheel hubcap, or wheel cover, if any ⇒ *Wheel trim*.

### WARNING

Wheel bolts that are tightened or installed improperly can come loose, causing loss of vehicle control, a crash, and serious personal injury.

- Always keep wheel bolts and threads in the wheel hub clean and free of oil and grease. The wheel bolts must turn easily and must be tightened with the right torque.
- Use the hexagonal socket in the screwdriver handle only to turn the wheel bolts when they are loose, never to loosen them or tighten them firmly.

### WARNING

Improper use of a collapsible spare tire can cause loss of vehicle control, a crash or other accident, and serious personal injury.

- Never use a collapsible spare tire if it is damaged or worn down to the wear indicators.
- Never drive faster than 50 mph (80 km/h) with a collapsible spare tire. Avoid full-throttle acceleration, heavy braking, and fast cornering!
- Never drive more than 125 miles (200 km) with a 16" collapsible spare wheel that is installed on the front axle (drive axle).
- Replace the collapsible spare with a normal wheel and tire as soon as possible. Collapsible spare tires are designed for brief use only.

## After changing a wheel

---

 Please first read and note the introductory information and heed the WARNINGS 

- Clean the tools in the vehicle tool kit if necessary and stow them in the foam insert in the luggage compartment ⇒ *Vehicle tool kit*.
- Securely store the collapsible spare tire or the tire you took off the vehicle in the luggage compartment.
- Have the wheel bolt tightening torque immediately checked with a torque wrench ⇒ *Wheel bolt tightening torque*.
- Have the damaged wheel replaced as soon as possible.

 If factory-installed wheels and/or tires are replaced, make sure that the tires are equipped with sensors that are compatible with the factory-installed Tire Pressure Monitoring System (TPMS) and with the wheels ⇒ *Tire Pressure Monitoring System (TPMS)* and ⇒ *New and replacement tires*.

 If new tires are not identical to those that were removed and require different cold tire inflation pressure, the tire inflation pressure values must be reprogrammed for the TPMS. Please see your authorized Volkswagen dealer or authorized Volkswagen Service Facility ⇒ *Tire Pressure Monitoring System (TPMS)*.

# Fuses

## Introduction

---

In this section you'll find information about:

Fuses in the vehicle

Replacing blown fuses

Due to ongoing development of the vehicle, configuration-dependent allocation of fuses and the combined fuse protection of multiple loads using one fuse, an up-to-date overview of the fuse location per load is not possible at the time of printing. Detailed information regarding fuse box layout is available from authorized Volkswagen dealers and authorized Volkswagen Service Facilities.

In general, one fuse can protect several loads. One load can also be protected by several fuses.

Find out why the fuse blew and correct the problem before replacing a blown fuse. If a newly replaced fuse blows again after a short time, the electrical system should be checked by an authorized Volkswagen dealer or an authorized Volkswagen Service Facility.

### More information:

- Working in the engine compartment

### WARNING

High voltage systems in the engine compartment can cause electrical shocks, severe burns, and even death!

- Never touch ignition cables. Never touch other components of the high-voltage electronic ignition system.
- Avoid short circuits in the electrical system.

### WARNING

Using the wrong fuse, using a blown fuse that has been repaired, and using metal objects in place of fuses to complete the electrical connection in the circuit can cause fires and serious personal injury.

- Never replace a fuse with one that has a higher amp rating. Replace a blown fuse only with a fuse of the same amperage (same color and same imprint) and same overall size.
- Never repair fuses.
- Never replace fuses with a metal strip, a paper clip, or a similar object.

### NOTICE

- To help prevent damage to the electrical system, switch off all lights and accessories, switch off the ignition, and remove the key from the ignition switch before replacing a fuse.
- If a fuse is replaced with a fuse with higher amperage, this can also cause damage at different locations in the electrical system.
- Open fuse boxes must be protected from dirt and moisture. Dirt and moisture in fuse boxes can cause damage to the electrical system.

## Fuses in the vehicle

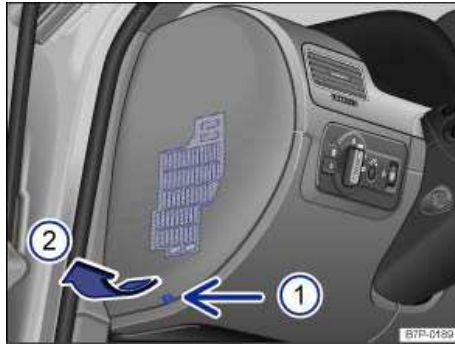

Fig. 345 On the left side of the instrument panel: Remove the fuse box cover.

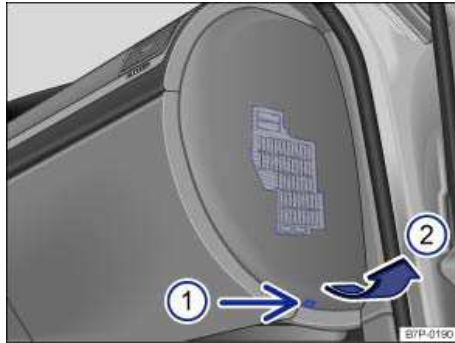

Fig. 346 On the right side of the instrument panel: Remove the fuse box cover.

**⚠ Please first read and note the introductory information and heed the WARNINGS ⚠**

Replace a blown fuse only with a fuse of the same amperage (same color and same imprint) and same overall size.

### Fuse color coding

Color	Current strength in amps
Purple	3
Light brown	5
Brown	7,5
Red	10

Color	Current strength in amps
Blue	15
Yellow	20
White or clear	25
Green	30
Orange	40

#### Opening the fuse box in the instrument panel

- Insert a flat object, such as the screwdriver in the vehicle tool kit, into the opening ⇒ [fig. 345 \(1\)](#) or ⇒ [fig. 346 \(1\)](#) and carefully pry off the cover in the direction of the arrow [\(2\)](#).

#### NOTICE

- To help prevent vehicle damage, be careful when removing fuse box covers and be sure to reinstall them properly.
- Open fuse boxes must be protected from dirt and moisture. Dirt and moisture in fuse boxes can cause damage to the electrical system.

 The vehicle contains other fuses in addition to those mentioned in this chapter. Have these fuses replaced by an authorized Volkswagen dealer or an authorized Volkswagen Service Facility.

#### Replacing blown fuses

---

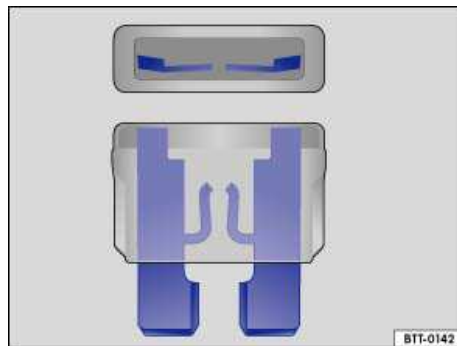

**Fig. 347** Illustration of a blown fuse.



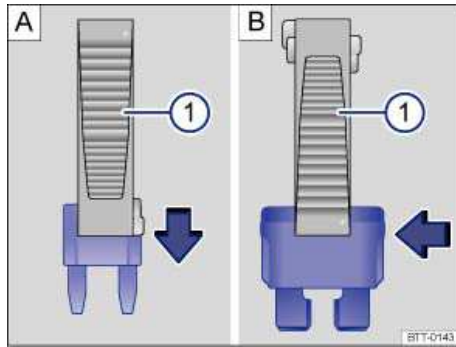

Fig. 348 Removing or inserting a fuse.

ⓘ Please first read and note the introductory information and heed the WARNINGS ⚠

#### Preparations

- Switch off the headlights, the ignition, and all electrical consumers.
- Open the appropriate fuse box

#### Identifying blown fuses

A blown fuse can be recognized by the burned metal strip ⇒ fig. 347.

Shine a flashlight on the fuse. This makes it easier to recognize a blown fuse.

#### Replacing the fuse

- If needed, remove the plastic tweezers ⇒ fig. 348 from the fuse box cover.
- For *small fuses*, slide the tweezers onto the fuse from the top ⇒ fig. 348 A.
- For *larger fuses*, slide the tweezers onto the fuse from the side ⇒ fig. 348 B.
- Pull out the blown fuse.
- If the fuse is blown, replace the fuse with a new fuse of the *same* amperage (same color and same imprint) and *same* overall size ⇒ ⚠.
- If necessary, replace the plastic tweezers in the fuse box cover.
- Replace the cover.

#### ⚠ NOTICE

If a fuse is replaced with a fuse with higher amperage, then damage can occur at various places in the electrical system.

# Replacing light bulbs

## Introduction

---

In this section you'll find information about:

Indicator lights

Changing a light bulb requires a certain amount of skill. Therefore, Volkswagen recommends having the light bulb changed by an authorized Volkswagen dealer or an authorized Volkswagen Service Facility. Special training and knowledge are generally required when other vehicle parts must be disassembled to replace a bulb, or when HID – High Intensity Discharge (Xenon) headlights must be replaced.

You should always keep a box in the vehicle with all the replacement bulbs required for traffic safety. Replacement bulbs are available from your authorized Volkswagen dealer or authorized Volkswagen Service Facility. The laws of some countries explicitly require you to have replacement bulbs in the vehicle.

Driving with outside lights that do not work may be against the law.

To obtain the Volkswagen service information necessary to change light bulbs yourself

### **Additional light bulb specifications**

Some factory-installed light bulbs in the headlights or the rear lights may have different specifications than conventional light bulbs. Specifications are on the glass bulb or on the metal base.

### **More information:**

- Exterior views
- Lights and vision
- Hybrid drive
- Working in the engine compartment
- Vehicle tool kit
- Fuses



### **WARNING**

**Crashes and other accidents can happen when you cannot see the road ahead and when you cannot be seen by other motorists.**

 **WARNING**

Improper replacement of burned out headlights and other light bulbs can cause serious personal injury.

- Stop! Always read and heed the WARNINGS before doing any work in the engine compartment ⇒ *Working in the engine compartment*. The engine compartment of any motor vehicle is a potentially dangerous area, and work in this area can lead to serious personal injury.
- HID – High Intensity Discharge (Xenon) get power from a high-voltage source that can cause severe personal injury and even death if handled improperly.
- H7 bulbs and HID – High Intensity Discharge (Xenon) are under high pressure and can explode if handled improperly.
- Always let a burned out light bulb cool down before replacing it.
- Never replace a light bulb unless you are familiar with all of the necessary procedures. In particular, never remove a headlight unless you know exactly how to carry out the job and have the correct tools and light bulbs.
- If you are uncertain about what to do, have the work performed by an authorized Volkswagen dealer, an authorized Volkswagen Service Facility, or another qualified workshop. Serious personal injury may result from improperly performed work.
- We strongly recommend that you always have HID - High Intensity Discharge (Xenon) lamps and H7 bulbs replaced by a qualified technician.
- Do not touch the glass of light bulbs with your bare hands. Fingerprints left on the bulb evaporate due to the heat when the bulb is switched on and cause the reflector to “cloud”.
- There are sharp edges on and around the headlight housing in the engine compartment and the taillight housing. Wear hand protection if you replace bulbs.



 **NOTICE**

After replacing a headlight bulb or other light bulb, always make sure that the rubber covers or plastic caps have been properly and securely reinstalled to help prevent water from getting into the electrical connections and headlight housing and damaging the electrical system.

## Indicator lights

 Please first read and note the introductory information and heed the WARNINGS 

Lights up	Possible cause	Proper response
	Headlight not working.	See an authorized Volkswagen dealer, an authorized Volkswagen Service Facility, or other qualified workshop to replace the light bulb that isn't working.

	<p>One or more brake lights burned out.</p>	<p>See an authorized Volkswagen dealer, an authorized Volkswagen Service Facility, or other qualified workshop to replace the light bulb that isn't working.</p>
	<p>License plate light not working.</p>	<p>See an authorized Volkswagen dealer, an authorized Volkswagen Service Facility, or other qualified workshop to replace the light bulb that isn't working.</p>

When the ignition is switched on, several warning and indicator lights come on briefly for a function check. They go out after a few seconds.



 **WARNING**

Failure to heed warning lights and instrument cluster text messages can cause the vehicle to break down in traffic and result in a collision and serious personal injury.

- Never ignore warning lights or text WARNINGS.
- Always stop the vehicle as soon as it is safe to do so.

 **NOTICE**

Failure to heed warning lights or text WARNINGS can result in vehicle damage.

 Failure of a single LED within a taillight is not indicated. However, the  indicator light will come on if all LEDs fail.

# Jump-starting

## Introduction

---

In this section you'll find information about:

Positive and negative jump-starting terminals  
Using jumper cables

If your engine does not start because the vehicle battery is dead, your vehicle's battery can be connected to the battery of another vehicle to start your engine (jump-starting).

You must use **jumper cables that meet recognized industrial standards** (check information provided by the jumper cable manufacturer). For vehicles with **gasoline engines**, the cross-section of the jumper cable wire must be at least 0.038 in<sup>2</sup> (25 mm<sup>2</sup>), or about 3 ga. (AWG). For vehicles with **diesel engines**, the cross-section must be at least 0.054 in<sup>2</sup> (35 mm<sup>2</sup>), or about 2 ga. (AWG).

On vehicles that do not have a battery in the engine compartment, connect the jumper cables only to the jump-start terminals in the engine compartment.

There is an opening for jump-starting located on the engine compartment cover

### More information:

- Hybrid drive
- Starting assistance systems
- Selective catalytic reduction (AdBlue®)
- Working in the engine compartment
- 12 Volt vehicle battery

### WARNING

**Working on the batteries or the electrical system in your vehicle can cause serious acid burns, fires, or electrical shock.**

- **Always keep children away from battery acid and vehicle batteries in general.**
- **Sulfuric battery acid is very corrosive and can cause blindness and damage to unprotected skin. Never let battery acid or lead particles contact your eyes, skin, and clothing.**
- **Never lean over a vehicle battery. Always wear protective gloves and eye protection. To reduce your risk of injury, never tilt the batteries; acid could spill out through the vents and burn you.**
- **A highly explosive mixture of gases is given off when the battery is being charged.**
- **Always avoid fires, sparks, open flame, and smoking. Never create sparks or electrostatic charges when handling cables and electrical equipment. Never short-circuit the battery terminals. High-energy sparks can cause serious personal injury.**
- **If you get battery acid in your eyes or on your skin, immediately rinse with cold water for several minutes and get medical attention immediately. If you swallow any battery acid, get medical attention immediately.**



## WARNING

Improper use of jumper cables when jump-starting a vehicle with a dead battery can cause the battery to explode, leading to serious personal injury. To help reduce the risk of battery explosion:

- All work on the batteries or the electrical system in your vehicle can cause serious acid burns, fires, or electrical shocks. Always read and heed the following WARNINGS and safety precautions before working on the batteries or the electrical system ⇒ *12 Volt vehicle battery*.
- Always make sure that the battery providing starting assistance (the booster battery) has the same voltage as the dead battery (12 V) and about the same amperage capacity (see battery label).
- Never jump-start a vehicle with a thawed or frozen battery. The battery can explode. A dead battery can freeze at temperatures around +32 °F (0 °C).
- A battery that is frozen or was frozen, but has since thawed, must be replaced.
- When the vehicle battery is jump-started, it gives off hydrogen gas, which is highly explosive! Always keep fire, sparks, open flame, and smoking materials far away from vehicle batteries. Never use a cellular telephone while connecting or disconnecting jumper cables.
- Jump-start batteries only in well-ventilated areas. Batteries give off highly explosive hydrogen gas during jump-starting.
- Always route the jumper cables so that they cannot get caught in any moving parts in the engine compartment.
- Never short out the battery terminals by connecting the positive terminal (+) and negative (-) terminals with each other.
- Never connect the negative cable from the other vehicle directly to the negative terminal of the dead battery, as this may cause the hydrogen gas given off by the dead battery to explode.
- Never attach the negative cable from the vehicle providing starting assistance to any part of the fuel system or to the brake hoses or brake lines.
- Never allow the non-insulated parts of the battery clamps to touch.
- Never allow the jumper cable attached to the positive battery terminal to contact metal parts of the vehicle.
- Always follow the instructions of the jumper cable manufacturer.



## NOTICE

To help prevent extensive damage to the vehicle electrical system, read and heed the following:

- Connecting jumper cables improperly can cause a short circuit and do expensive damage to the vehicle's electrical system.
- Do not let the vehicles touch each other while the jumper cables are connected. If they do, electrical current may flow between the vehicles when the positive (+) terminals are connected, causing electrical system damage.

## Positive and negative jump-starting terminals

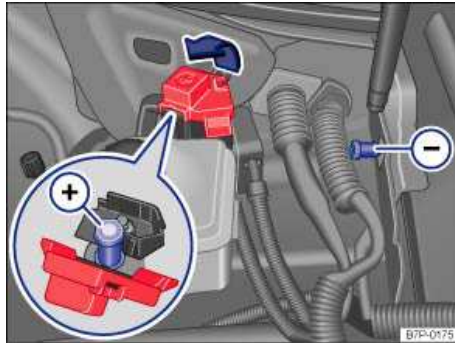

Fig. 349 In the engine compartment: Positive jump-start terminal + and negative jump-start terminal -.

⚠ Please first read and note the introductory information and heed the WARNINGS ⚠

The jump-starting terminals are in the engine compartment ⇒ fig. 349. The vehicle can only jump-start other vehicles or be jump-started itself by means of these terminals.

There is an opening for jump-starting located on the engine compartment cover ⇒ *Hybrid drive*.

## Using jumper cables

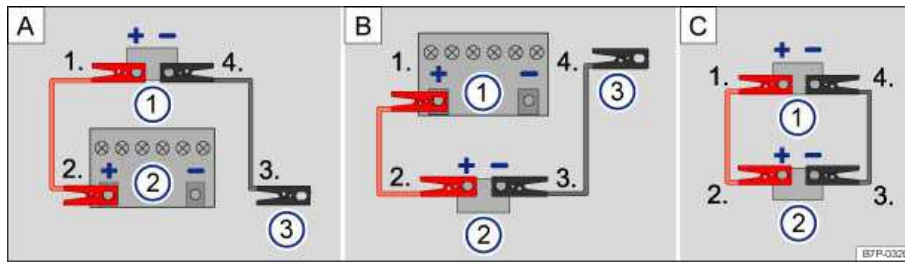

Fig. 350 The jumper cables are attached according to diagram A, B or C depending on how the vehicle is equipped.

⚠ Please first read and note the introductory information and heed the WARNINGS ⚠

- (1) Vehicle with the dead battery (vehicle being jump-started).
- (2) Vehicle with the booster battery (vehicle providing starting assistance).
- (3) Suitable ground connection. A solid metal part bolted directly to the engine block or the engine block itself.

The dead battery must be properly connected to the vehicle's electrical system.

Make certain that the vehicles are not touching each other. Otherwise, electric current could flow as soon as the positive terminals (+) are connected. Use longer jumper cables if necessary.

The clamps on the jumper cables must have good contact to bare metal on the battery terminals.

If the engine does not start, stop the process after 10 seconds and repeat after about 1 minute.

The procedure for attaching and for removing the jumper cables is described below. Perform each of the following steps only in the order in which it is described.

---

### Before you begin

---

- ✓ Switch off the ignition in both vehicles.
  - ✓ Open the hoods of both vehicles.
  - ✓ Remove the cover from the positive terminal on your vehicle and, if necessary, the battery cover of the other vehicle.
- 

### Diagram A: Attaching jumper cables

---

Diagram **A** applies where the vehicle with the dead battery has jump-start terminals (1) and is being jump-started by a vehicle whose battery is in the engine compartment (2) ⇒ ⚠.

1. Attach one end of the *red* jumper cable to the **positive jump-start terminal (+)** of the vehicle with the dead battery (1).
  2. Attach the other end of the *red* jumper cable to the **positive terminal (+)** of the booster battery (2).
  3. Connect one end of the *black* jumper cable to a suitable ground connection (3) on the vehicle with the booster battery (2). A suitable ground connection is a solid metal part bolted directly to the engine block of the vehicle with the booster battery or this vehicle's engine block itself.
  4. Attach the other end of the *black* jumper cable to the **negative jump-start terminal (-)** of the vehicle with the dead battery (1).
- 

### Diagram B: Attaching jumper cables

---

Diagram **B** applies where the dead battery (1) is in the engine compartment of the vehicle being jump-started, and the vehicle providing starting assistance has jump-start terminals (2) ⇒ ⚠.

1. Attach one end of the *red* jumper cable to the **positive terminal (+)** of the dead battery (1).
  2. Attach the other end of the *red* jumper cable to the **positive jump-start terminal (+)** of the vehicle providing starting assistance (2).
  3. Attach one end of the *black* jumper cable to the **negative jump-start terminal (-)** of the vehicle providing starting assistance (2).
  4. Connect the other end of the *black* jumper cable to a suitable ground connection (3) on the vehicle with the dead battery (1). A suitable ground connection is a solid metal part bolted directly to the engine block of the vehicle with the dead battery or this vehicle's engine block itself.
- 

### Diagram C: Attaching jumper cables where both vehicles have jump-start terminals

---

Diagram **C** applies where the vehicle with the dead battery has jump-start terminals (1) and is being jump-started by a vehicle that also has jump-start terminals (2) ⇒ ⚠.

1. Attach one end of the *red* jumper cable to the **positive jump-start terminal (+)** of the vehicle with the dead battery (1).
  2. Attach the other end of the *red* jumper cable to the **positive jump-start terminal (+)** of the vehicle providing starting assistance (2).
  3. Attach one end of the *black* jumper cable to the **negative jump-start terminal (-)** of the vehicle providing starting assistance (2).
  4. Attach the other end of the *black* jumper cable to the **negative jump-start terminal (-)** of the vehicle with the dead battery (1).
- 

### Starting the engine

---

1. Start the engine of the vehicle with the good battery that is providing help and let it run at idle speed.



2. Turn the ignition of the vehicle with the dead battery. If the engine starts, wait 2 to 3 minutes until it "runs smoothly" before removing the jumper cables as described below ⇒ . If the engine does not start within about 10 seconds, turn off the ignition and wait at least 1 minute; then try again.

---

#### **Before removing the jumper cables**

---

1. Switch off the headlights (if they are on).
2. In the vehicle with the dead battery, switch on the heater fan and the rear window defroster. This helps to minimize voltage spikes when the cables are disconnected.

---

#### **Removing the jumper cables**

---

1. Before you remove the jumper cables, switch off the headlights (if they are on).
  2. In the vehicle with the dead battery, switch on the heater fan and the rear window defroster. This helps to minimize voltage spikes when the jumper cables are disconnected.
  3. With the engine running, remove the jumper cables **in reverse order** to the way they were connected. Specifically:
    - Disconnect the black (–) cable from the vehicle with the **dead** battery.
    - Disconnect the black (–) cable from the other vehicle (vehicle with the **good** battery).
    - Disconnect the red (+) cable from the other vehicle (vehicle with the **good** battery).
    - Disconnect the red (+) cable from the vehicle with the **dead** battery.
  4. Turn off the heater fan and the rear window defroster on the vehicle with the dead battery.
  5. Snap the cap of the positive jump-start terminal back on, reinstall covers, and close engine hoods.
-



## WARNING

Improper use of jumper cables when jump-starting a vehicle with a dead battery can cause the battery to explode, leading to serious personal injury. To help reduce the risk of battery explosion:

- All work on the batteries or the electrical system in your vehicle can cause serious acid burns, fires, or electrical shocks. Always read and heed the following WARNINGS and safety precautions before working on the batteries or the electrical system ⇒ *12 Volt vehicle battery*.
- Always wear proper eye protection. Never lean over the vehicle batteries.
- Attach the jumper cables in the correct order: first the positive cable, then the negative cable.
- Never connect the negative cable from the vehicle providing starting assistance to parts of the fuel system or to the brake hoses or brake lines.
- Never allow the non-insulated parts of the battery clamps to touch.
- Never allow the jumper cable attached to the positive battery terminal to contact metal parts of the vehicle.
- Specialized knowledge and tools are required to access the vehicle battery. For this reason, have an authorized Volkswagen dealer or an authorized Volkswagen Service Facility check the electrolyte level of the vehicle battery.
- Avoid electrostatic discharge in the vicinity of the vehicle battery. Sparks may cause the hydrogen gas escaping from the vehicle battery to ignite.
- Never jump-start a vehicle with a battery that is damaged or frozen or that was frozen and has thawed. The battery can explode. Replace the battery instead.
- Always follow the instructions of the jumper cable manufacturer.
- Always make sure that the battery providing starting assistance has the same voltage as the dead battery (12 V) and about the same capacity (see battery label).
- Batteries give off explosive hydrogen gas. Always keep fire, sparks, open flame and smoking materials away from batteries.
- Never connect the negative cable from the other vehicle directly to the negative terminal of the dead battery. The hydrogen gas from the battery is explosive.
- Never short out the battery terminals by connecting the positive (+) and negative (-) terminals with each other.



## NOTICE

Checking the electrolyte level

- The 12 Volt vehicle battery is located under the left front seat. Specialized knowledge and tools are required to access the vehicle battery. For this reason, have an authorized Volkswagen dealer or an authorized Volkswagen Service Facility check the electrolyte level of the vehicle battery.

# Towing

## Introduction

---

In this section you'll find information about:

- Towing on a commercial tow truck
- Tips on towing
- Installing the front towing eye
- Installing the rear towing eye
- Driving tips while towing

Observe legal requirements when towing.

Your vehicle is equipped with a trailer package.

**For technical reasons:**

- **A vehicle with a dead battery must never be towed; Jump-start the vehicle instead.**
- **It is not possible to tow-start or push-start your vehicle; Jump-start the vehicle instead.**

Vehicles with Keyless Access may only be towed with the ignition on.

Towing the vehicle when the engine is turned off and the ignition is turned on drains the vehicle battery. Depending on the charge level of the vehicle battery, it is possible that even after just a few minutes, electrical devices such as the emergency flashers may not have the power necessary to function. The steering wheel might lock in vehicles with Keyless Access ⇒ .

**More information:**

- Exterior views
- Engine control and emission control system

### **WARNING**

**Never tow a vehicle without any electrical power.**

- **Never remove the remote control vehicle key from the ignition switch while the vehicle is moving. The electronic steering column lock could suddenly engage, and you would not be able to steer or control the vehicle. You can lose control of the vehicle, crash, and seriously injure yourself and others.**
- **If the vehicle loses power while it is being towed, stop towing the vehicle immediately and contact your authorized Volkswagen dealer or authorized Volkswagen Service Facility for assistance.**

## WARNING

Towing a vehicle changes the way it handles and brakes. To help reduce the risk of an accident and serious personal injury, note the following:

- The driver of the vehicle that is being towed:
  - Since the brake booster also does not work when the engine is stopped, you will need to press harder on the brake pedal to slow down or stop. Always be alert so as not to rear-end towing vehicle.
  - Will have to use considerable more force to turn the steering wheel because the power steering is not working.
- The driver of the vehicle that is doing the towing:
  - Must accelerate gradually and gently and avoid jerking movements.
  - Must not brake hard or steer sharply.
  - Must brake earlier and more gently than in normal driving.

## WARNING

Never let the vehicle be towed unless its electrical system is working and the ignition is switched on. Otherwise, the steering column lock may engage, causing loss of control, a crash, and serious personal injuries.

## NOTICE

- Be careful not to damage the paint when installing and removing the towing eye and the cover for the threaded hole behind the bumper.
- Unburned fuel can get into the catalytic converter during towing and damage it.

## NOTICE

The vehicle may be damaged if it is towed with a tow rope or a tow bar.

- Never let the vehicle be towed with a tow rope or a tow bar unless it is absolutely necessary.
- If the vehicle breaks down, it can only be towed by a special tow truck.

## Towing on a commercial tow truck

 Please first read and note the introductory information and heed the WARNINGS 

To help avoid damaging the vehicle, have it towed only by a professional towing company. Read and heed the following information:

### General information

Never let the vehicle be towed at speeds above 30 mph (50 km/h).

Never let the vehicle be towed for more than 30 miles (50 km).

### Towing automatic transmission vehicles

- Release the parking brake.
- Shift the transmission into Neutral (N).

- Tow the vehicle only with its front wheels off the ground ⇒ .

### Special towing instructions for vehicles with all-wheel drive (4MOTION)

- To help prevent unnecessary damage, vehicles with all-wheel drive (4MOTION) must be transported on a flat-bed truck.
- To load the vehicle on the flat bed, use the towing eye found in the vehicle tool kit and attach it to the front anchorage ⇒ *Vehicle tool kit*, ⇒ *Installing the front towing eye*.

### When not to tow your vehicle

If there is little or no oil in the transmission because of damage to your vehicle, it must be moved with the drive wheels off the ground. The vehicle can only be towed if its ignition is switched on and its electrical system is operating. In the following situations, the vehicle cannot be towed at all and must be transported on a flatbed truck or trailer:

- If the front and rear wheels cannot turn.
- If the vehicle battery is dead (because the steering is locked and the electronic parking brake and the electronic steering column lock cannot be released if engaged).
- If you have to tow an automatic transmission vehicle more than 30 miles (50 km).

### WARNING

**It is not safe for children or other persons to ride in a vehicle that is being towed.**

- **Never let children or anyone else remain in the vehicle while it is being towed.**

### NOTICE

**The drive axle rotates while the vehicle is being towed with its rear wheels off the ground. This can damage the automatic transmission.**

- **Never tow automatic transmission vehicle with the rear wheels off the ground.**

## Tips on towing

 Please first read and note the introductory information and heed the WARNINGS 

### Towing eye; tow rope or tow bar

A towing eye is included in your vehicle's tool kit. This can be inserted in a threaded hole in the front bumper and used when your vehicle is being towed by another vehicle. On most vehicles, there is another threaded hole in the rear bumper, so you can use the towing eye to tow other vehicles as well. Towing a vehicle with a tow bar is safer and easier on both vehicles than using a tow rope. A tow rope should be used only if a tow bar is not available.

The tow rope should be flexible enough to help protect both vehicles from damage. Use a synthetic fiber rope or similar rope.

Attach the tow rope or tow bar only to the towing eye included in the vehicle tool kit for this purpose, or to a trailer hitch.

### Towing manual transmission vehicles

Check whether your vehicle can be towed at all; see below *When not to tow your vehicle*.

If yes, note the following for the towed vehicle:

- Shift the gearshift lever to Neutral ⇒ *Shifting*.

- Do not tow faster than 30 mph (50 km/h).
- Do not tow more than 30 miles (50 km).

#### **Towing automatic transmission vehicles**

Check whether your vehicle can be towed at all; see below *When not to tow your vehicle*.

If yes, note the following for the towed vehicle:

- Put the transmission in Neutral (**N**).
- Do not tow faster than 30 mph (50 km/h).
- Do not tow more than 30 miles (50 km).
- When a commercial tow truck is being used, the vehicle must only be towed with the front wheels lifted off the ground.
- Follow the special instructions for towing vehicles with all-wheel drive (4MOTION).

#### **Towing vehicles with all-wheel drive (4MOTION)**

Vehicles with all-wheel drive (4MOTION) should be towed with a tow bar or a tow rope. If the vehicle is towed with the front or rear axles lifted off the ground, the engine must be switched off. Otherwise the powertrain may be damaged.

#### **When not to tow your vehicle**

In the following situations, the vehicle cannot be towed and must be transported on a flatbed truck or trailer:

- If transmission fluid has leaked out of the transmission.
- If there is little or no oil in the transmission because of damage to your vehicle, it must be moved with the drive wheels off the ground.
- If the front and rear wheels cannot turn.
- When the vehicle battery is dead, since the steering may remain disabled, and it may not be possible to release the electronic steering column lock and the electronic parking brake.
- If you have to tow an automatic transmission vehicle more than 30 miles (50 km).

#### **Towing other vehicles**

- Obey all legal requirements.
- Read and heed all towing information in the owner's manual for the other vehicle.



A vehicle can be towed only if the electronic parking brake and the electronic steering column lock can be released. In case of a power loss or malfunctions of the electrical system, the engine may have to be jump-started in order to release the electronic parking brake and the electronic steering column lock.

## Installing the front towing eye

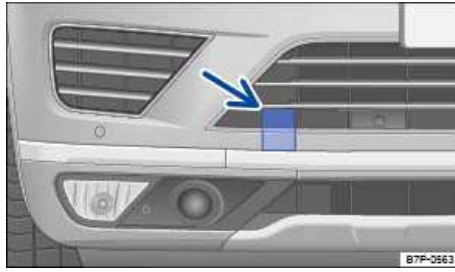

Fig. 351 In right front bumper: Removing the cover.

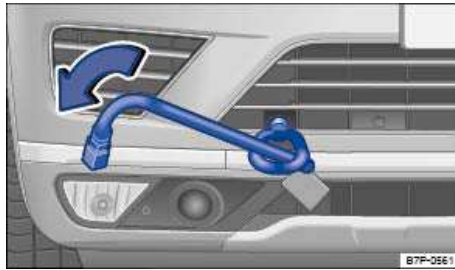

Fig. 352 In right front bumper: Screwing in towing eye.

⚠ Please first read and note the introductory information and heed the WARNINGS ⚠

Holes for the towing eyes are in the front bumper at the right and at the left.

Always keep the towing eye in the vehicle and stow it securely.

Read and follow the notes about towing ⇒ *Tips on towing*.

### Installing the front towing eye

- Take the towing eye, the lug wrench, and the screwdriver out of the vehicle tool kit in the luggage compartment ⇒ *Vehicle tool kit*.
- Push the outboard edge of the cover ⇒ fig. 351.
- Reach behind the cover, pull it off, and let it hang from the vehicle.
- Screw the towing eye **counterclockwise** into the threaded hole as far as it will go ⇒ fig. 352 (arrow) ⇒ ①. Use the lug wrench to turn and tighten the towing eye.
- When towing is complete, unscrew the towing eye **clockwise** to remove it and replace the cover.
- Clean the towing eye and lug wrench if necessary and put them back in the vehicle tool kit in the luggage compartment.

### ⓘ NOTICE

Always make sure the towing eye is screwed all the way into threaded hole so that it is secure. Otherwise, it could be ripped out while your vehicle is being towed.

## Installing the rear towing eye

---

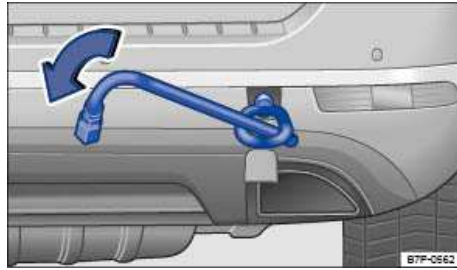

Fig. 353 In right rear bumper: Screwing in towing eye.

ⓘ Please first read and note the introductory information and heed the WARNINGS ⚠

Holes for the screw-in towing eyes are in the rear bumper at the right and at the left.

Follow towing instructions

### Installing the rear towing eye

- Take the towing eye, the lug wrench, and the screwdriver out of the vehicle tool kit in the luggage compartment ⇒ *Vehicle tool kit*.
- Push the outboard edge of the cover.
- Reach behind the cover, pull it off, and let it hang from the vehicle.
- Screw the towing eye **counterclockwise** into the threaded hole as far as it will go ⇒ fig. 353 (arrow) ⇒ ①. Use the lug wrench to turn and tighten the towing eye.
- When towing is complete, unscrew the towing eye **clockwise** to remove it and replace the cover.
- Clean the towing eye and lug wrench if necessary and put them back in the vehicle tool kit in the luggage compartment.

### ⓘ NOTICE

**Always make sure the towing eye is screwed all the way into threaded hole so that it is secure. Otherwise, it could be ripped out while your vehicle is being towed.**

## Driving tips while towing

---

ⓘ Please first read and note the introductory information and heed the WARNINGS ⚠

Towing requires some experience, especially when using a towing rope. Both drivers must be familiar with the techniques required for towing. Inexperienced drivers should not try to tow a vehicle or to drive a vehicle that is being towed.

Do not pull too hard with the towing vehicle, and avoid jerking the tow rope. When towing on an unpaved road, there is always a risk of overloading and damaging the attachment points.

If your vehicle is being towed, it can still signal turns even if the emergency flashers are activated, as long as the ignition is switched on. Use the turn signal in the normal way. The emergency flashers go off as long as the turn signal is blinking. As soon as the turn signal lever returns to its neutral position, the emergency flashers are automatically activated again.



**As driver of the towed vehicle:**

- If your vehicle is the one being towed, the ignition switch must be switched on to keep the steering wheel from locking. Also make sure that the turn signals, horn, windshield wipers, and windshield washers work properly.
- Since power steering does not work when the engine is switched off, more effort is needed to steer the vehicle.
- Since the brake booster also does not work when the engine is stopped, you will need to press harder on the brake pedal to slow down or stop. Do not hit the towing vehicle.
- Read and heed the information and WARNINGS in the towing vehicle's owner's manual.

**As driver of the towing vehicle**

- Drive especially carefully and accelerate gently. Avoid sudden driving maneuvers.
- Brake earlier than usual and with light pedal pressure.
- Read and heed the information and WARNINGS in the owner's manual of the vehicle being towed.

## Abbreviations

<b>Abbreviation</b>	<b>Meaning</b>
A2DP	Advanced Audio Distribution Profile for cross-manufacturer Bluetooth audio signal transmission compatibility.
ABS	Anti-lock Brake System.
AFS	Adaptive Front Lighting System.
AKI	Anti-Knock Index.
AM	AM (amplitude modulation).
ANSI	American National Standards Institute.
ASL	Automatic Shift Lock.
ASR	Anti-Slip Regulation.
ATA	Anti-Theft Alarm system.
BAS	Brake Assist System.
cc	Cubic centimeter unit of volume for specifying engine displacement.
ccm	Cubic centimeters. Unit of measure for engine displacement.
CCS	Cruise Control System.
CCS	Cruise Control System.
CID	Cubic inch displacement, unit of volume for specifying engine displacement.
cm	Centimeter – metric unit of measure for length.
CO <sub>2</sub>	Carbon dioxide.
DIN	Deutsches Institut für Normung (German Institute for Standardization).
DPF	Diesel Particulate Filter.
DRL	Daytime Running Lights.
DTMF	Dual Tone Multiple Frequency.
EDL	Electronic Differential Lock.
EN	European Norm.
EON	Enhanced Other Network (support for other radio networks).
EPC	Engine control (Electronic Power Control).
ESC	Electronic Stability Control.
ETC	Electronic Toll Collection system.
FLA	Headlight assistant.
FSI	Fuel Stratified Injection.
g/mi	Generated carbon monoxide amount in grams per mile driven.

GAWR	Gross Axle Weight Rating.
GSM	Global System for Mobile Communications.
GVWR	Gross Vehicle Weight Rating.
HDD	Media Center (Hard Disk Drive).
HFP	Hands-Free-Profile (mobile phone operation).
HID	High Intensity Discharge headlights (HID).
hp	Horsepower, engine power rating.
IMEI	International Mobile Station Equipment Identity (unique serial number for identification of GSM terminal devices).
kg	Kilogram – metric unit for weight.
kN	Kilonewton, tractive force.
kp	Kilopond, a measure of force.
kPa	Kilopascal, unit of measure for tire pressure.
kW	Kilowatt, engine rating.
LED	Light Emitting Diode.
m	Meter – metric unit of measure for length.
MDI	Media Device Interface.
MFI	Multi-Function Indicator.
MP3	Audio file compression format.
Nm	Newton meter, engine torque unit.
OPS	Optical Parking System.
PDC	Park Distance Control.
PIN	Personal identification number.
RDS	Radio Data System (enables additional functions).
RON	Research Octane Number, measurement of anti-knock resistance of gasoline.
rpm	Engine revolutions per minute (engine speed).
rSAP	Remote SIM Access Profile (via Bluetooth).
SAE	Society of Automotive Engineers.
SIM	Subscriber Identity Module.
SMS	Short Message Service.
TDI <sup>®</sup>	Turbocharged Direct Injection (Turbocharged diesel engine with direct fuel injection).
TIN	Tire Identification Number.
TMC	Traffic Message Channel (for dynamic navigation).

TP	Traffic Program (radio traffic bulletins).
UTQG	Uniform Tire Grading Quality.
VBR	Variable bit rate.
WMA	Audio file compression format.